



EGLO

my light | my style



TREND & STYLE

COLLECTION

2023/24





## TREND & STYLE

### COLLECTION

Dear business partners and faithful friends of EGLO,

We are pleased to present the new Trend & Style catalogue 2023/24. In addition to our novelties and known favourites, we have introduced a new trend into the assortment, Japandi. This style combines Japanese and Scandinavian designs that reflect a minimalist and functional aesthetic. Japandi-style luminaires are characterised by their simplicity, clean lines and use of natural materials.

Add a touch of sophistication to your living space with our vintage collection of lighting fixtures. From rustic chandeliers to pendant lights and table lamps, our products showcase the elegance of lighting and will transform your space into something special.

True to our philosophy, "my light | my style", you will find the perfect lighting solution for every interior in the new Trend & Style catalogue.

Geschätzte Geschäftspartner\*innen, treue EGLO Freund\*innen,

wir freuen uns, Ihnen den neuen Trend & Style Katalog 2023/24 präsentieren zu dürfen. Neben einer Vielzahl an Neuheiten und bereits bekannten Lieblingsartikeln überraschen wir mit einem neuen Trend: Japandi, eine Kombination aus japanischem und skandinavischem Stil, spiegelt eine minimalistische und funktionale Ästhetik wieder. Die Leuchten im Japandi-Stil zeichnen sich durch ihre Einfachheit, klaren Linien und den Einsatz von natürlichen Materialien aus.

Verleihen Sie Ihrem Wohnraum einen Hauch von Raffinesse mit unseren Leuchten aus der Vintage-Kollektion. Von rustikalen Kronleuchtern über Hängeleuchten bis hin zu Tischleuchten präsentieren sie zeitlose Eleganz der Vergangenheit und machen Ihre Räumlichkeiten zu etwas ganz Besonderen.

Ganz nach unserem Credo „my light | my style“ findet sich im neuen Trend & Style Katalog eine Leuchte für jeden Einrichtungsstil.

Chers partenaires, chers amis fidèles d'EGLO,

Nous avons le plaisir de vous présenter le nouveau catalogue Trend & Style 2023/24. Outre une multitude de nouveautés et d'articles favoris déjà connus, nous vous surprenons avec une nouvelle tendance: Japandi, une combinaison des styles japonais et scandinave, reflétant une esthétique minimaliste et fonctionnelle. Les luminaires de style Japandi se distinguent par leur simplicité, leurs lignes épurées et l'utilisation de matériaux naturels.

Ajoutez une touche sophistiquée à votre intérieur avec nos luminaires de la collection Tend & Styles. Des lustres rustiques aux lampes de table en passant par les suspensions, ils représentent l'élégance intemporelle du passé et font de votre espace un lieu très spécial.

Conformément à notre credo „my light | my style“, vous trouverez dans le nouveau catalogue Trend & Style un luminaire pour chaque style d'intérieur.

# EDITORIAL

Our Trend & Style collection features the latest trends for the 2023/24 season.

Our luminaire portfolio has been expanded to include exciting compositions made from natural materials, metal and glass. Exciting compositions made of natural materials, metal and glass have been added to our luminaire portfolio. Dried bamboo and birch leaves on flax fleece and luminaires made of paper are the highlights of our new luminaire designs.

In der Trend & Style Kollektion erwarten Sie die aktuellen Trend-Welten der Saison 2023/24.

Unser Leuchten Portfolio wurde um spannende Kompositionen aus Naturmaterialien, Metall und Glas ergänzt. Getrocknete Bambus- und Birkenblätter auf Flachsfließ und Leuchten aus Papier sind die Highlights unserer neuen Leuchten-Designs.

Dans la collection Trend & Style, vous trouverez toutes les tendances actuelles de la saison 2023/24.

Notre portefeuille de luminaires a été complété par des compositions passionnantes en matériaux naturels, métal et verre. Des feuilles de bambou et de bouleau séchées sur un voile de lin et des luminaires en papier sont les points forts de nos nouveaux designs de luminaires.

INDUSTRIAL

P.4



LOFT

P.76



JAPANDI

P.194



NATURE

P.206

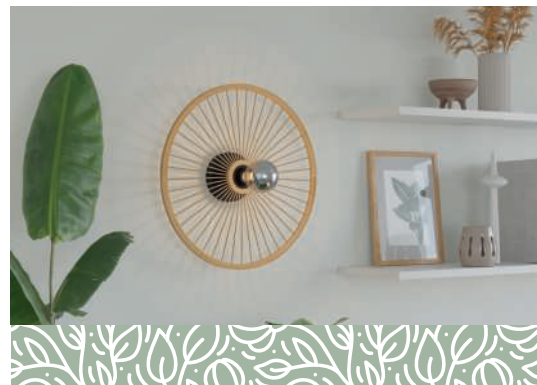

COTTAGE CHIC

P.234



VINTAGE

P.248



ETHNO ELEGANCE

P.264



SOCKETS & ILLUMINANTS

P.278



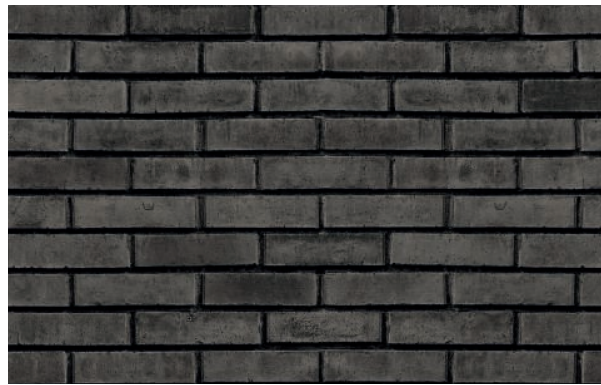

# INDUSTRIAL

#RAW  
#BRICKS

Soft lines, playful curves and comfort? Certainly not. The industrial range is dominated by hard and functional elements. Raw metal parts are turned into luminaires and spread the rough style of factory halls. The Industrial Look celebrates the aesthetic of things imperfect.

Weiche Linien, verspielte Rundungen und Gemütlichkeit? Mitnichten. Im Industrial Sortiment dominieren harte und funktionelle Elemente. Rohe Metallteile werden zu Leuchten verarbeitet und verbreiten den groben Stil von Fabrikhallen. Der Industrial Look zelebriert die Ästhetik des Imperfekten.

Des lignes tendres, des arrondis enjoués et de la convivialité ? En aucun cas. Des éléments durs et fonctionnels dominant la gamme industrielle. Des pièces métalliques brutes sont usinées pour devenir des luminaires et diffusent le style franc d'usines. Le look industriel symbolise l'esthétique de l'imperfection.

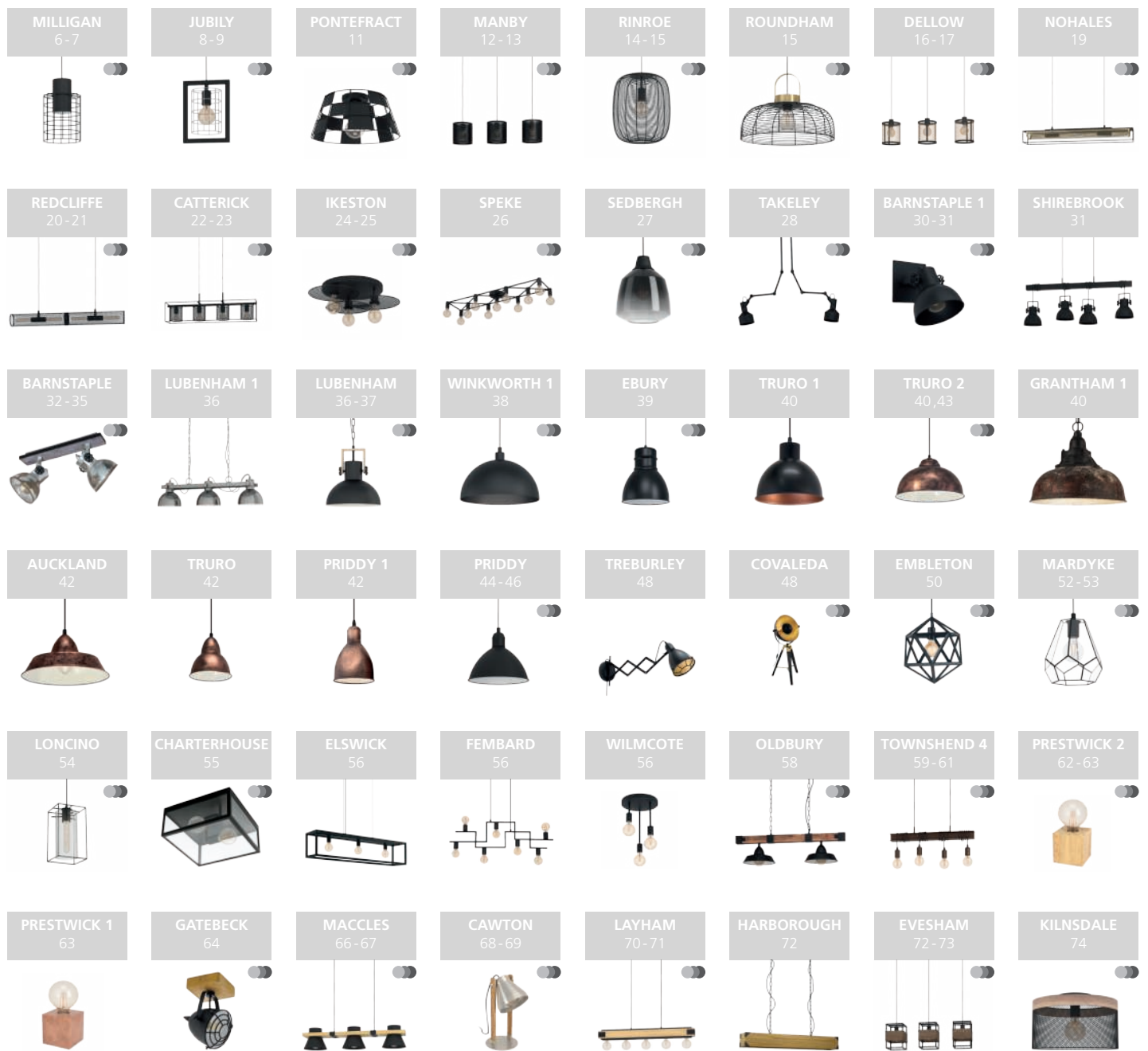

This product is available in different colors and shapes./ Dieser Artikel ist in unterschiedlichen Farben und Formen verfügbar.  
Cet article est disponible en différentes couleurs et formes.



### 43625 MILLIGAN

pendant light; steel, black, white  
 Hängeleuchte; Stahl, schwarz, weiss  
 luminaire en suspension; acier, noir, blanc

H 1100, Ø 200



E27 1x 40W



9 002759 436254



### 43626 MILLIGAN

pendant light; steel, black, white  
 Hängeleuchte; Stahl, schwarz, weiss  
 luminaire en suspension; acier, noir, blanc

L 1030, B 200, H 1100



E27 3x 40W



9 002759 436261

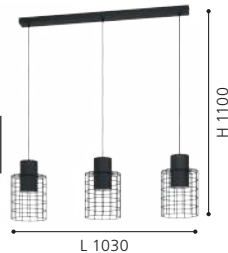

### 43628 MILLIGAN

pendant light; steel, black, white  
 Hängeleuchte; Stahl, schwarz, weiss  
 luminaire en suspension; acier, noir, blanc

H 1100, Ø 480



E27 1x 40W



9 002759 436285

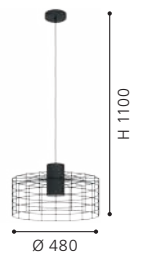





43627

### 43627 MILLIGAN

pendant light; steel, black, white  
Hängeleuchte; Stahl, schwarz, weiss  
luminaire en suspension; acier, noir, blanc

H 1100, Ø 380



E27



1x 40W



9 002759 436278

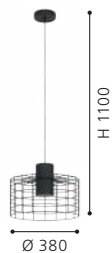

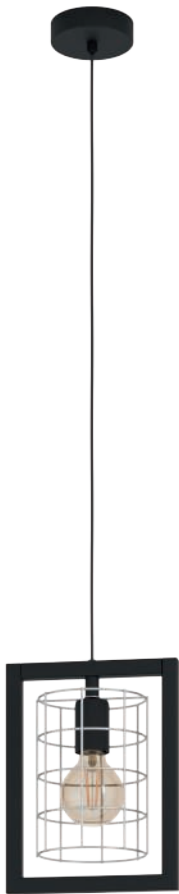

43662

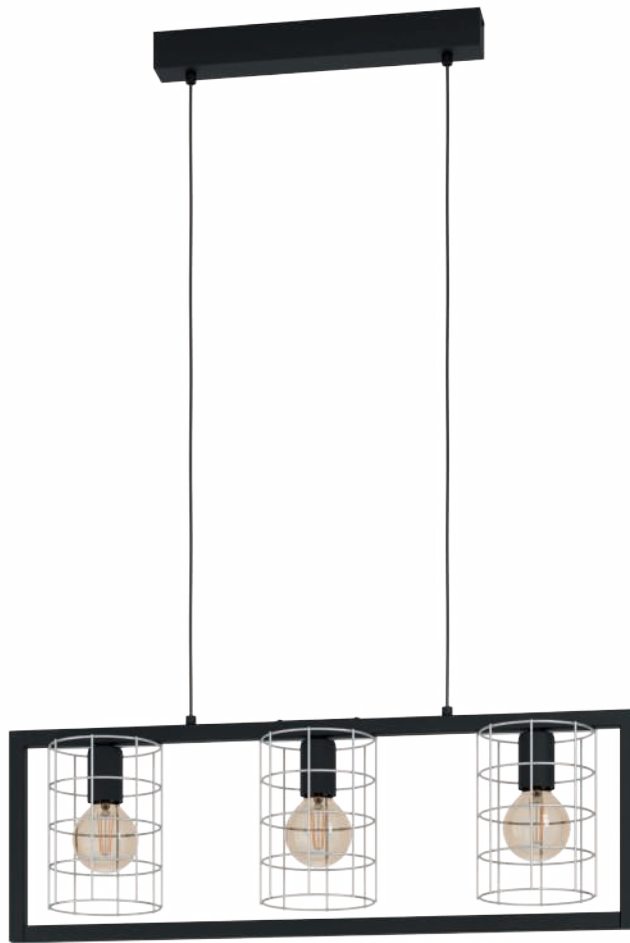

43663



43664

### 43662 JUBILY

pendant light; steel, black / steel, zinc-plated  
 Hängeleuchte; Stahl, schwarz / Stahl, verzinkt  
 luminaire en suspension; acier, noir / acier, galvanisé

L 220, B 145, H 1100



E27 1x 40W



9 002759 436629



### 43663 JUBILY

pendant light; steel, black / steel, zinc-plated  
 Hängeleuchte; Stahl, schwarz / Stahl, verzinkt  
 luminaire en suspension; acier, noir / acier, galvanisé

L 770, B 145, H 1100



E27 3x 40W



9 002759 436636

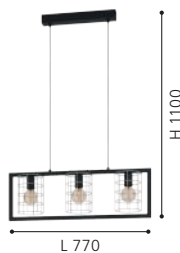

### 43664 JUBILY

wall light; steel, black / steel, zinc-plated  
 Wandleuchte; Stahl, schwarz / Stahl, verzinkt  
 Applique; acier, noir / acier, galvanisé

L 220, H 290, A 195



E27 1x 40W



9 002759 436643





43661



43665

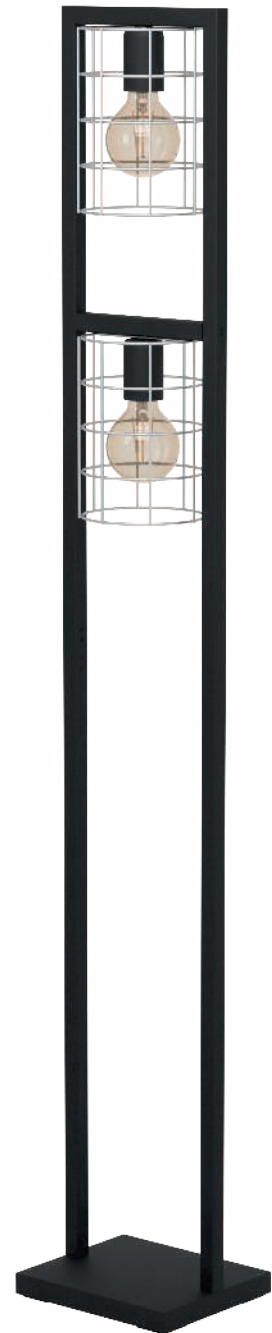

43666

### 43661 JUBILY

ceiling light; steel, black / steel, zinc-plated  
Deckenleuchte; Stahl, schwarz / Stahl, verzinkt  
plafonnier; acier, noir / acier, galvanisé

L 770, B 190, H 255



E27 3x 40W



9 002759 436612

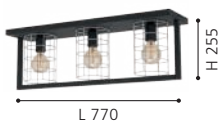

### 43665 JUBILY

table light; steel, black / steel, zinc-plated  
Tischleuchte; Stahl, schwarz / Stahl, verzinkt  
luminaire de table; acier, noir / acier, galvanisé

L 220, B 145, H 535, Base: B 220, T 150



E27 1x 40W



9 002759 436650



### 43666 JUBILY

floor light; steel, black / steel, zinc-plated  
Stehleuchte; Stahl, schwarz / Stahl, verzinkt  
lampadaire; acier, noir / acier, galvanisé

L 220, B 145, H 1455, Base: B 220, T 190



E27 2x 40W



9 002759 436667

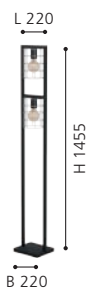



43891

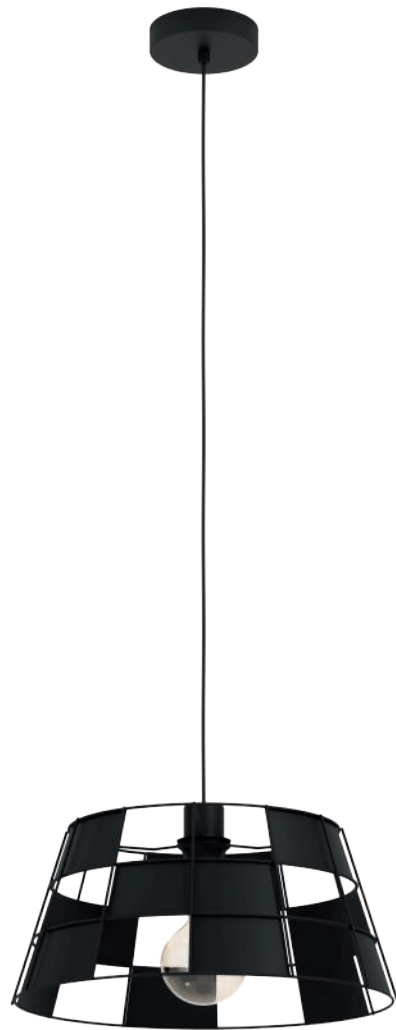

43892

DESIGN  
HIGHLIGHT  
DETAIL



### 43891 PONTEFRACT

ceiling light; steel, black  
Deckenleuchte; Stahl, schwarz  
plafonnier; acier, noir

H 205, Ø 420



E27



1x 40W



9 002759 438913



### 43892 PONTEFRACT

pendant light; steel, black  
Hängeleuchte; Stahl, schwarz  
luminaire en suspension; acier, noir

H 1100, Ø 420



E27



1x 40W



9 002759 438920





43796

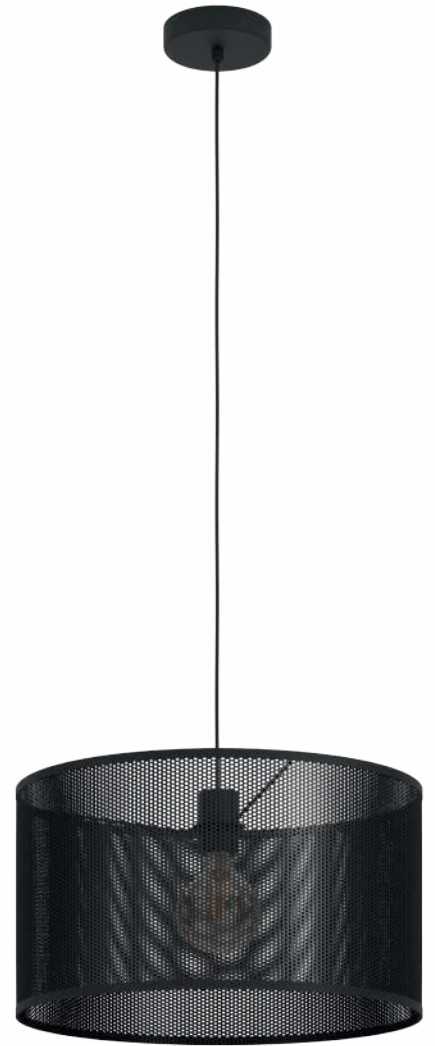

43795

### 43796 MANBY

pendant light; steel, black  
 Hängeleuchte; Stahl, schwarz  
 luminaire en suspension; acier, noir

L 900, B 200, H 1100



E27



3x 40W



9 002759 437961



### 43795 MANBY

pendant light; steel, black  
 Hängeleuchte; Stahl, schwarz  
 luminaire en suspension; acier, noir

H 1100, Ø 450



E27



1x 40W



9 002759 437954

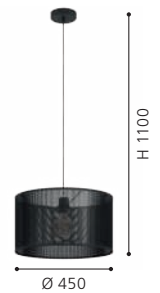



43794



### 43794 MANBY

ceiling light; steel, black  
Deckenleuchte; Stahl, schwarz  
plafonnier; acier, noir

H 280, Ø 450



E27



1x 40W



9 002759 437947

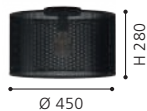

### 43797 MANBY

table light; steel, black  
Tischleuchte; Stahl, schwarz  
luminaire de table; acier, noir

H 485, Ø 240, Base: Ø 230



E27



1x 40W



9 002759 437978





DESIGN  
HIGHLIGHT  
DETAIL



43966

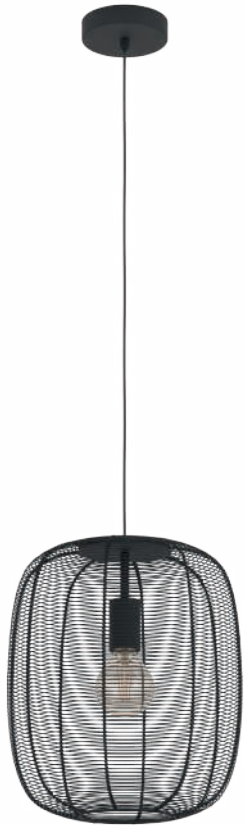

43965

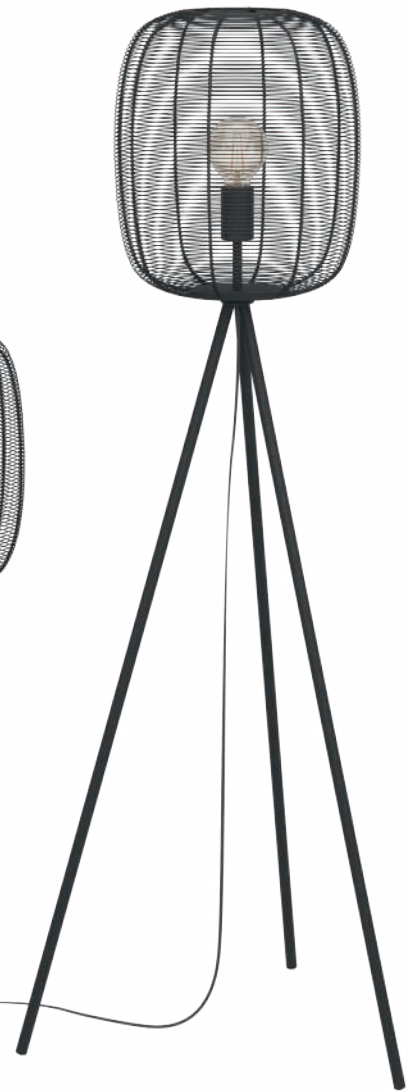

43968

### 43965 RINROE

pendant light; steel, black  
Hängeleuchte; Stahl, schwarz  
luminaire en suspension; acier, noir

H 1100, Ø 325



E27 1x 40W



9 002759 439651



### 43966 RINROE

pendant light; steel, black  
Hängeleuchte; Stahl, schwarz  
luminaire en suspension; acier, noir

L 900, B 325, H 1100



E27 2x 40W



9 002759 439668



### 43968 RINROE

floor light; steel, black  
Stehleuchte; Stahl, schwarz  
lampadaire; acier, noir

H 1405, Ø 325, Base: Ø 630



E27 1x 40W



9 002759 439682

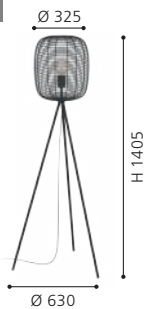





### 43967 RINROE

table light; steel, black  
Tischleuchte; Stahl, schwarz  
luminaire de table; acier, noir

H 440, Ø 200, Base: Ø 225



E27 1x 40W



9 1002759 439675



### 43964 ROUNDHAM

pendant light; steel, black, brushed brass  
Hängeleuchte; Stahl, schwarz, messing-gebürstet  
luminaire en suspension; acier, noir, laiton brossé

H 1100, Ø 450



E27 1x 40W



9 1002759 439644

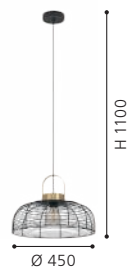

### 43963 ROUNDHAM

pendant light; steel, black, brushed brass  
Hängeleuchte; Stahl, schwarz, messing-gebürstet  
luminaire en suspension; acier, noir, laiton brossé

H 1100, Ø 220



E27 1x 40W



9 1002759 439637





43605



43603

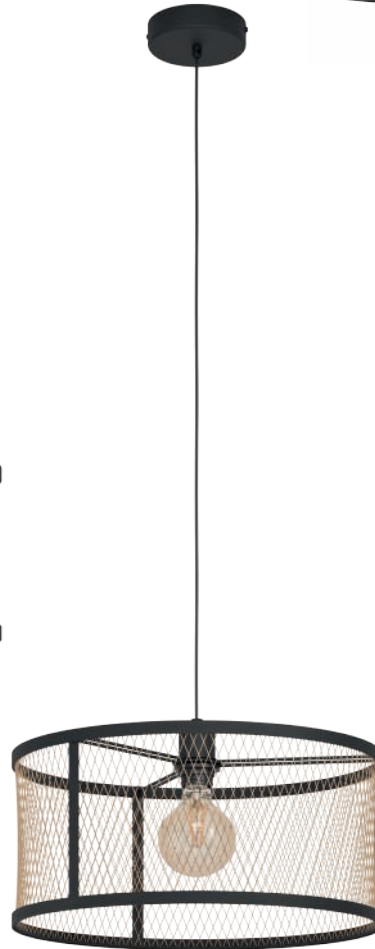

43604

### 43605 DELLOW

pendant light; steel, black / steel, black, brass  
 Hängeleuchte; Stahl, schwarz / Stahl, schwarz, messing  
 luminaire en suspension; acier, noir / acier, noir, laiton

L 880, B 180, H 1100



E27 3x 40W



9 002759 436056



### 43604 DELLOW

pendant light; steel, black / steel, black, brass  
 Hängeleuchte; Stahl, schwarz / Stahl, schwarz, messing  
 luminaire en suspension; acier, noir / acier, noir, laiton

H 1100, Ø 450



E27 1x 40W



9 002759 436049



### 43603 DELLOW

ceiling light; steel, black / steel, black, brass  
 Deckenleuchte; Stahl, schwarz / Stahl, schwarz, messing  
 plafonnier; acier, noir / acier, noir, laiton

H 270, Ø 450



E27 1x 40W



9 002759 436032

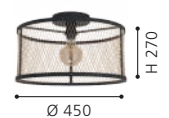



43533



43531



43532

### 43533 DELLOW

spot; steel, black / steel, black, brass  
 Spot; Stahl, schwarz / Stahl, schwarz, messing  
 spot; acier, noir / acier, noir, laiton

L 830, B 180, H 210



E27



3x 40W



9 002759 435332



L 830

H 210

### 43532 DELLOW

spot; steel, black / steel, black, brass  
 Spot; Stahl, schwarz / Stahl, schwarz, messing  
 spot; acier, noir / acier, noir, laiton

L 475, B 180, H 210



E27



2x 40W



9 002759 435325



L 475

H 210

### 43531 DELLOW

spot; steel, black / steel, black, brass  
 Spot; Stahl, schwarz / Stahl, schwarz, messing  
 spot; acier, noir / acier, noir, laiton

L 180, B 110, H 200



E27



1x 40W



9 002759 435318

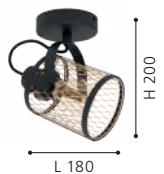

L 180

H 200



43788

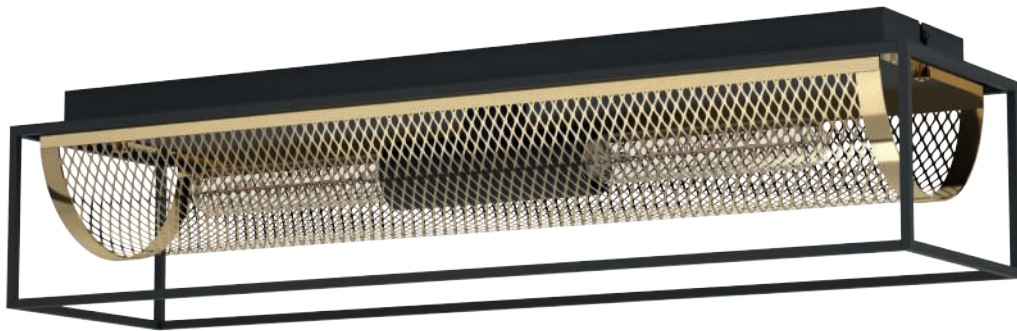

43787



43789



### 43788 NOHALES

pendant light; steel, black, brass  
Hängeleuchte; Stahl, schwarz, messing  
luminaire en suspension; acier, noir, laiton

L 1120, B 170, H 1500



E27



4x 40W



9 002759 437886



### 43789 NOHALES

wall light; steel, black, brass  
Wandleuchte; Stahl, schwarz, messing  
Applique; acier, noir, laiton

L 170, H 320, A 145



E27



1x 40W



9 002759 437893



### 43787 NOHALES

ceiling light; steel, black, brass  
Deckenleuchte; Stahl, schwarz, messing  
plafonnier; acier, noir, laiton

L 640, B 170, H 145



E27



2x 40W



9 002759 437879

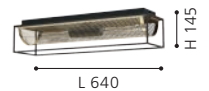



#### DETAIL 43534

To replace the bulbs, the lamp can be taken apart in the middle.  
 Zum Tausch der Leuchtmittel können die beiden Hälften der Leuchte in der Mitte auseinander genommen werden.  
 Pour remplacer les ampoules, la luminaire peut être démontée au milieu.



#### 43534 REDCLIFFE

pendant light; steel, black  
 Hängeleuchte; Stahl, schwarz  
 luminaire en suspension; acier, noir

L 1080, B 125, H 1100



E27



4x 40W



9 002759 435349

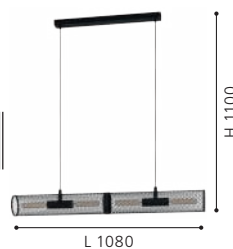

#### 43535 REDCLIFFE

wall/ceiling light; steel, black  
 Wand- / Deckenleuchte; Stahl, schwarz  
 Applique/Plafonnier; acier, noir

L 540, B 120, H 145



E27



2x 40W



9 002759 435356

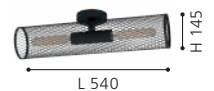



43538



43536



43537

### 43538 REDCLIFFE

wall light; steel, black  
Wandleuchte; Stahl, schwarz  
Applique; acier, noir

L 120, H 280, A 145



E27



1x 40W



9 002759 435387



### 43536 REDCLIFFE

table light; steel, black  
Tischleuchte; Stahl, schwarz  
luminaire de table; acier, noir

H 380, Ø 120, Base: Ø 120



E27



1x 40W



9 002759 435363



### 43537 REDCLIFFE

floor light; steel, black  
Stehleuchte; Stahl, schwarz  
lampadaire; acier, noir

H 1355, Ø 120, Base: Ø 250



E27



4x 40W



9 002759 435370



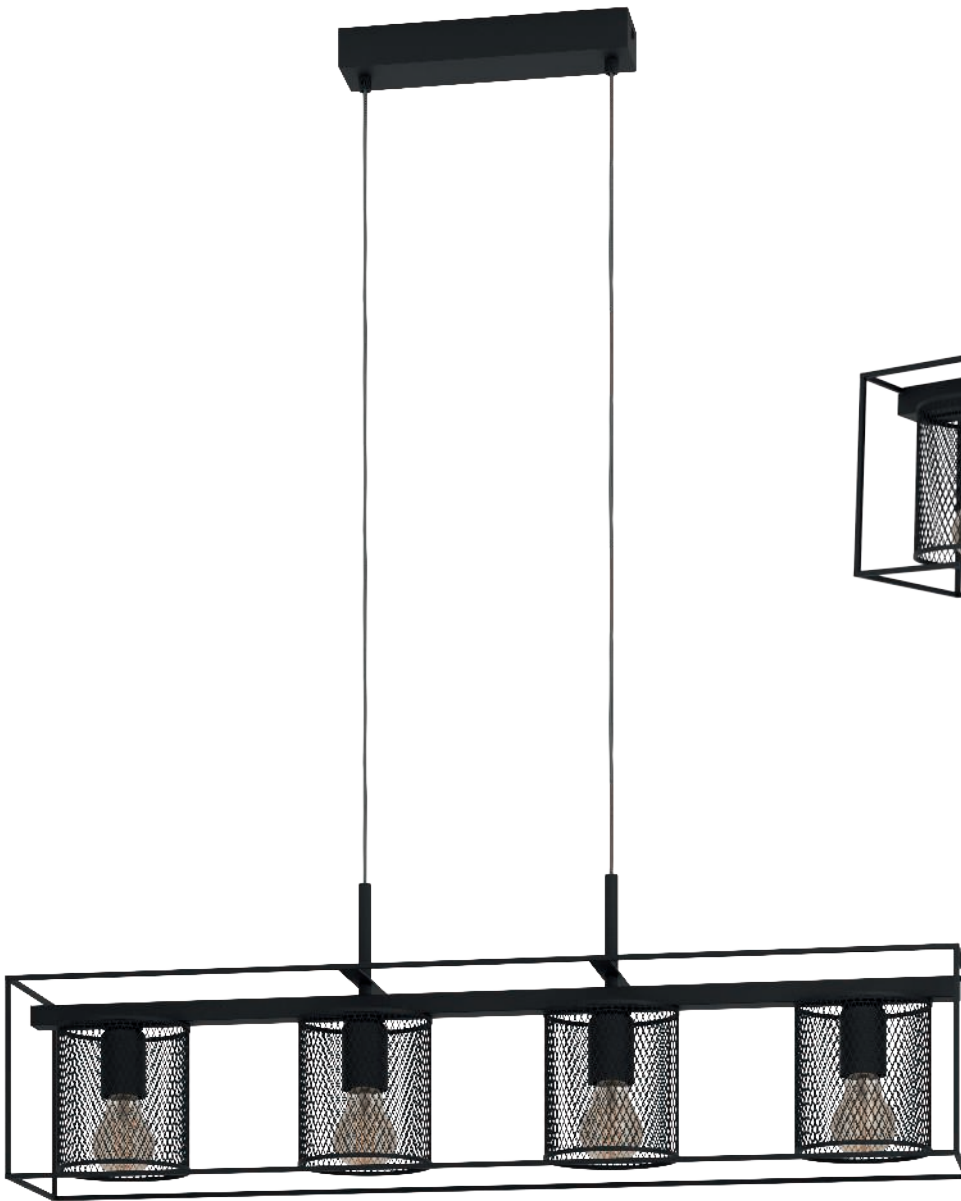

43773



43772

### 43773 CATTERICK

pendant light; steel, black  
Hängeleuchte; Stahl, schwarz  
luminaire en suspension; acier, noir

L 910, B 165, H 1100



E27 4x 40W



9 002759 437732

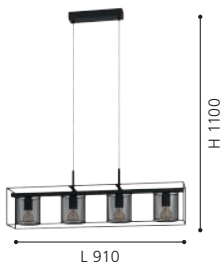

### 43772 CATTERICK

ceiling light; steel, black  
Deckenleuchte; Stahl, schwarz  
plafonnier; acier, noir

L 350, B 165, H 190



E27 2x 40W



9 002759 437725



### 43771 CATTERICK

ceiling light; steel, black  
Deckenleuchte; Stahl, schwarz  
plafonnier; acier, noir

L 165, B 165, H 190



E27 1x 40W



9 002759 437718







43771



43774

### 43774 CATTERICK

table light; steel, black  
Tischleuchte; Stahl, schwarz  
luminaire de table; acier, noir

L 165, B 165, H 190



E27



1x 40W



9 002759 437749

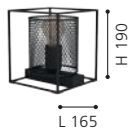

DESIGN  
HIGHLIGHT  
DETAIL





43728

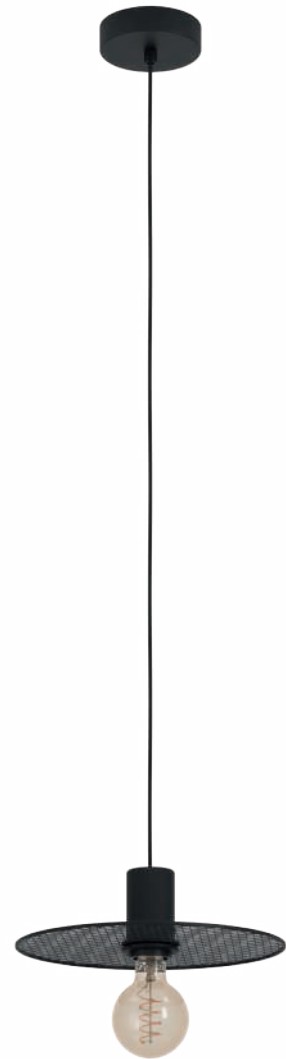

43731

### 43728 IKESTON

ceiling light; steel, black  
Deckenleuchte; Stahl, schwarz  
plafonnier; acier, noir

H 130, Ø 530



E27



3x 40W



9 002759 437282



### 43731 IKESTON

pendant light; steel, black  
Hängeleuchte; Stahl, schwarz  
luminaire en suspension; acier, noir

H 1100, Ø 280



E27



1x 40W



9 002759 437312

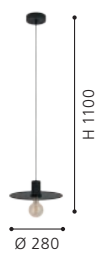



43729



43732

### 43732 IKESTON

pendant light; steel, black  
Hängeleuchte; Stahl, schwarz  
luminaire en suspension; acier, noir

L 980, B 280, H 1100



E27



4x 40W



9 002759 437329

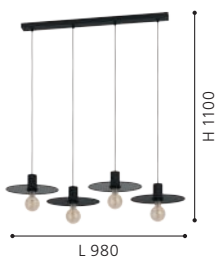

### 43729 IKESTON

ceiling light; steel, black  
Deckenleuchte; Stahl, schwarz  
plafonnier; acier, noir

L 950, B 330, H 120



E27



4x 40W



9 002759 437299





### 43722 SPEKE

ceiling light; steel, black  
Deckenleuchte; Stahl, schwarz  
plafonnier; acier, noir

L 1560, B 310, H 105



E27



11x 40W



9 002759 437220

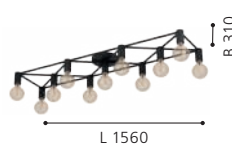

### 43721 SPEKE

ceiling light; steel, black  
Deckenleuchte; Stahl, schwarz  
plafonnier; acier, noir

L 415, B 310, H 105



E27



5x 40W



9 002759 437213

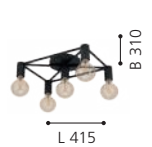

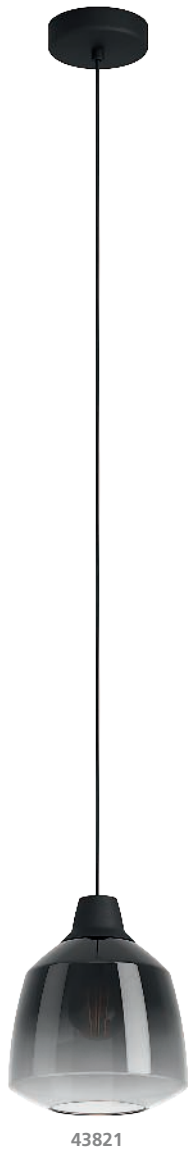

43821



43822

### 43821 SEDBERGH

pendant light; steel, black / glass, black-grey-transparent  
 Hängeleuchte; Stahl, schwarz / Glas, schwarz-grau-transparent  
 luminaire en suspension; acier, noir / verre, noir gris transparent

H 1100, Ø 200



E27



1x 40W



9 002759 438210



### 43822 SEDBERGH

pendant light; steel, black / glass, black-grey-transparent  
 Hängeleuchte; Stahl, schwarz / Glas, schwarz-grau-transparent  
 luminaire en suspension; acier, noir / verre, noir gris transparent

L 900, B 200, H 1100



E27



3x 40W



9 002759 438227



DESIGN  
HIGHLIGHT  
DETAIL



## DETAIL TAKELEY

The arms of the luminaires are individually adjustable.  
Die Arme der Leuchten sind individuell einstellbar.  
Les bras des luminaires sont réglables individuellement.

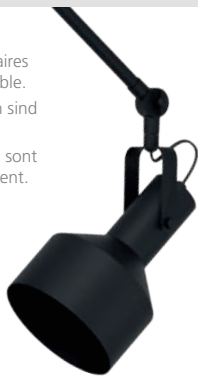

43562

### 43562 TAKELEY

ceiling light; steel, black  
Deckenleuchte; Stahl, schwarz  
plafonnier; acier, noir

B 1980, H 1325



E27



2x 28W



9 002759 435622

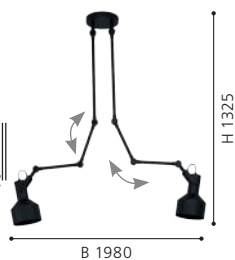

### 43561 TAKELEY

ceiling light; steel, black  
Deckenleuchte; Stahl, schwarz  
plafonnier; acier, noir

H 1325, Ø 150



E27



1x 28W



9 002759 435615

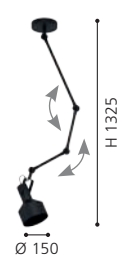



43561





43431



43432



43433

### 43431 BARNSTAPLE 1

spot; wood, steel, black / steel, black  
Spot; Holz, Stahl, schwarz / Stahl, schwarz  
spot; bois, acier, noir / acier, noir

L 160, B 160



E27 1x 28W



9 002759 434311

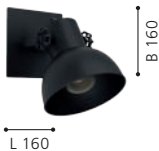

L 160

B 160

### 43432 BARNSTAPLE 1

spot; wood, steel, black / steel, black  
Spot; Holz, Stahl, schwarz / Stahl, schwarz  
spot; bois, acier, noir / acier, noir

L 475, B 90



E27 2x 40W



9 002759 434328



L 475

B 90

### 43433 BARNSTAPLE 1

spot; wood, steel, black / steel, black  
Spot; Holz, Stahl, schwarz / Stahl, schwarz  
spot; bois, acier, noir / acier, noir

L 750, B 90



E27 3x 40W



9 002759 434335



L 750

B 90





43434



43726



### 43434 BARNSTAPLE 1

spot; wood, steel, black / steel, black  
Spot; Holz, Stahl, schwarz / Stahl, schwarz  
spot; bois, acier, noir / acier, noir

L 450, B 450



E27



4x 40W



9 002759 434342



### 43726 SHIREBROOK

pendant light; steel, wood, black  
Hängeleuchte; Stahl, Holz, schwarz  
luminaire en suspension; acier, bois, noir

L 1000, B 250, H 1100



E27



4x 40W



9 002759 437268

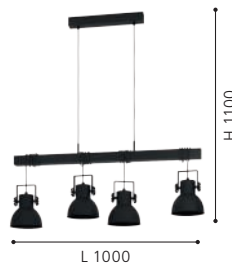



49649



49653



49652

### 49649 BARNSTAPLE

spot; wood, steel, brown-patina, black / steel, distressed zinc  
Spot; Holz, Stahl, braun-patina, schwarz / Stahl, used look Zink  
spot; bois, acier, marron patiné, noir / acier, look zinc usé

L 475, B 90



E27 2x 40W



9 002759 496494



L 475

### 49652 BARNSTAPLE

spot; wood, steel, brown-patina, black / steel, distressed zinc  
Spot; Holz, Stahl, braun-patina, schwarz / Stahl, used look Zink  
spot; bois, acier, marron patiné, noir / acier, look zinc usé

L 750, B 90



E27 3x 40W



9 002759 496524



L 750

### 49653 BARNSTAPLE

spot; wood, steel, brown-patina, black / steel, distressed zinc  
Spot; Holz, Stahl, braun-patina, schwarz / Stahl, used look Zink  
spot; bois, acier, marron patiné, noir / acier, look zinc usé

L 450, B 450



E27 4x 40W



9 002759 496531



L 450



49648

### 49648 BARNSTAPLE

spot; wood, steel, brown-patina, black / steel, distressed zinc  
Spot; Holz, Stahl, braun-patina, schwarz / Stahl, used look Zink  
spot; bois, acier, marron patiné, noir / acier, look zinc usé

L 160, B 160



E27



1x 40W



9 002759 496487





49647



49722



49718

### 49647 BARNSTAPLE

pendant light; wood, steel, brown-patina, black / steel, distressed zinc

Hängeleuchte; Holz, Stahl, braun-patina, schwarz / Stahl, used look Zink

luminaire en suspension; bois, acier, marron patiné, noir / acier, look zinc usé

H 1500, Ø 270



E27 3x 40W



9 002759 496470

### 49722 BARNSTAPLE

floor light; wood, steel, brown-patina, black / steel, distressed zinc

Stehleuchte; Holz, Stahl, braun-patina, schwarz / Stahl, used look Zink

lampadaire; bois, acier, marron patiné, noir / acier, look zinc usé

H 1580, Base: Ø 270

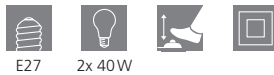

E27 2x 40W

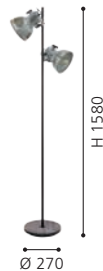

9 002759 497224

### 49718 BARNSTAPLE

table light; wood, steel, brown-patina, black / steel, distressed zinc

Tischleuchte; Holz, Stahl, braun-patina, schwarz / Stahl, used look Zink

luminaire de table; bois, acier, marron patiné, noir / acier, look zinc usé

B 175, H 400, Base: Ø 180



E27 1x 40W



9 002759 497187



49619

### 49619 BARNSTAPLE

pendant light; steel, black / steel, distressed zinc  
Hängeleuchte; Stahl, schwarz / Stahl, used look Zink  
luminaire en suspension; acier, noir / acier, look zinc usé

H 1100, Ø 175



E27



1x 40W



9 1002759 496197



DESIGN  
HIGHLIGHT  
DETAIL





43168



43164



43162

### 43168 LUBENHAM 1

pendant light; steel, antique nickel, cream  
 Hängeleuchte; Stahl, nickel-antik, creme  
 luminaire en suspension; acier, nickel antique, crème

L 900, B 200, H 1100



E27 3x 28W



9 002759 431686

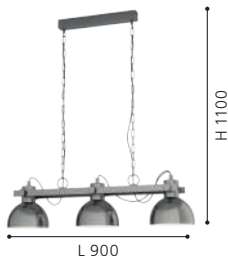

### 43162 LUBENHAM

pendant light; steel, wood, black, brown  
 Hängeleuchte; Stahl, Holz, schwarz, braun  
 luminaire en suspension; acier, bois, noir, marron

H 1100, Ø 300



E27 1x 28W



9 002759 431624

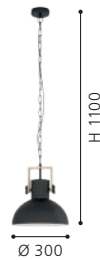

### 43164 LUBENHAM

wall light; steel, wood, black, brown  
 Wandleuchte; Stahl, Holz, schwarz, braun  
 Applique; acier, bois, noir, marron

L 175, H 205, A 210



E27 1x 28W



9 002759 431648





43165



43166



43163

### 43165 LUBENHAM

table light; steel, wood, black, brown  
Tischleuchte; Stahl, Holz, schwarz, braun  
luminaire de table; acier, bois, noir, marron

L 355, H 570, Base: Ø 180



E27 1x 28W



9 002759 431655



### 43166 LUBENHAM

floor light; steel, wood, black, brown  
Stehleuchte; Stahl, Holz, schwarz, braun  
lampadaire; acier, bois, noir, marron

L 475, B 300, H 1600, Base: Ø 300



E27 1x 28W



9 002759 431662

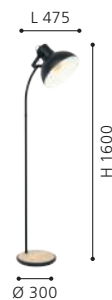

### 43163 LUBENHAM

pendant light; steel, wood, black, brown  
Hängeleuchte; Stahl, Holz, schwarz, braun  
luminaire en suspension; acier, bois, noir, marron

L 900, B 200, H 1100



E27 3x 28W



9 002759 431631

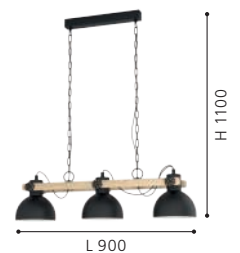



43435



43436



#### DETAIL WINKWORTH 1

The distance between light fitting and ceiling can be individually adjusted using the additional weight.

Der Abstand der Leuchte zur Decke ist durch das zusätzliche Gewicht individuell verstellbar.

L'espace séparant les têtes de luminaire du plafond peut être réglé grâce au poids supplémentaire.

#### 43435 WINKWORTH 1

pendant light; steel, black  
Hängeleuchte; Stahl, schwarz  
luminaire en suspension; acier, noir

H 910 - 1900, Ø 380



E27



1x 40W



9 002759 434359



#### 43436 WINKWORTH 1

pendant light; steel, black  
Hängeleuchte; Stahl, schwarz  
luminaire en suspension; acier, noir

L 1180, B 380, H 910 - 1900



E27



2x 40W



9 002759 434366







43621



43622

### 43621 Ebury

pendant light; steel, black, white  
Hängeleuchte; Stahl, schwarz, weiss  
luminaire en suspension; acier, noir, blanc

H 1100, Ø 380



E27



1x 60W



9 002759 436216



### 43622 Ebury

pendant light; steel, grey, white  
Hängeleuchte; Stahl, grau, weiss  
luminaire en suspension; acier, gris, blanc

H 1100, Ø 380



E27



1x 60W



9 002759 436223



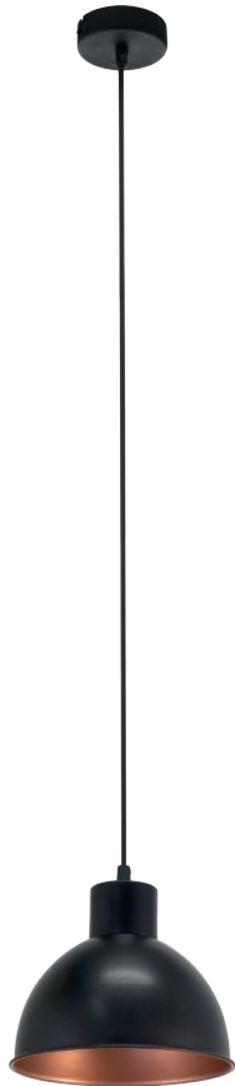

49238

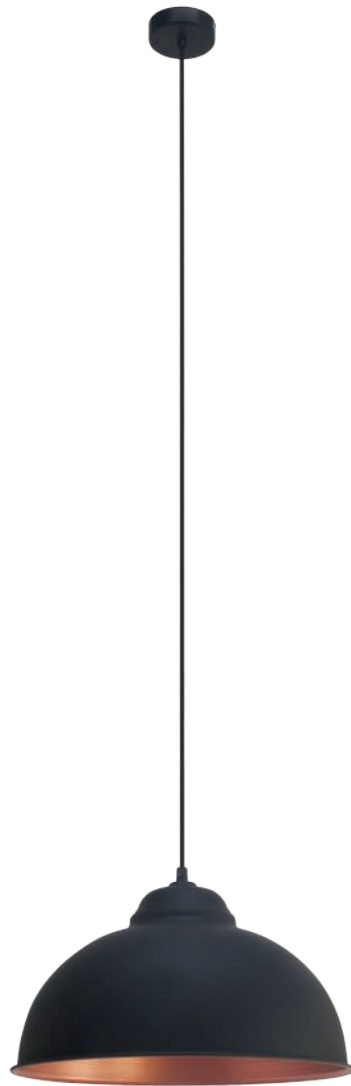

49247

### 49238 TRURO 1

pendant light; steel, black, copper  
Hängeleuchte; Stahl, schwarz, kupfer  
luminaire en suspension; acier, noir, cuivre

H 1100, Ø 210



E27 1x 60W



9 002759 492380



### 49247 TRURO 2

pendant light; steel, black, copper  
Hängeleuchte; Stahl, schwarz, kupfer  
luminaire en suspension; acier, noir, cuivre

H 1100, Ø 370



E27 1x 60W



9 002759 492472



### 49819 GRANTHAM 1

pendant light; steel, antique brown, beige  
Hängeleuchte; Stahl, antik-braun, beige  
luminaire en suspension; acier, marron antique, beige

H 1100, Ø 370



E27 1x 60W



9 002759 498191





49819

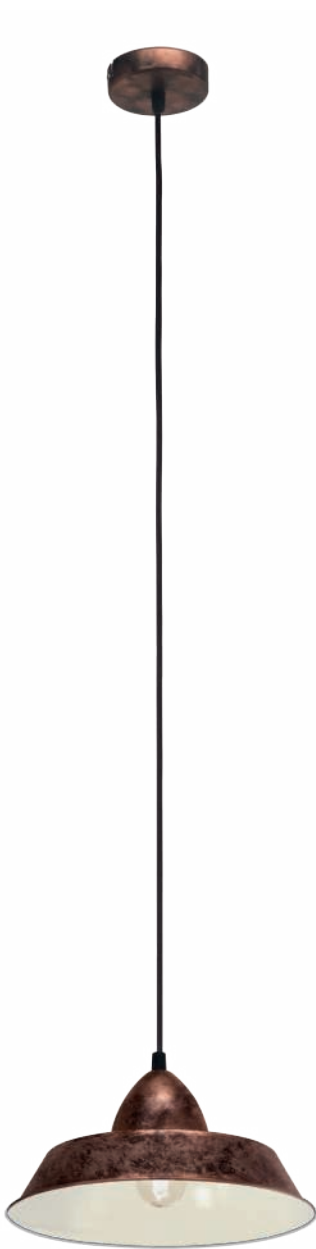

49243



49235



49492

### 49243 AUCKLAND

pendant light; steel, antique copper coloured  
Hängeleuchte; Stahl, kupferfarben-antik  
luminaire en suspension; acier, cuivré antique

H 1100, Ø 260



E27 1x 60W



9 002759 492434

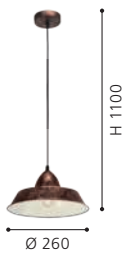

### 49235 TRURO

pendant light; steel, antique copper coloured  
Hängeleuchte; Stahl, kupferfarben-antik  
luminaire en suspension; acier, cuivré antique

H 1100, Ø 155



E27 1x 40W



9 002759 492359

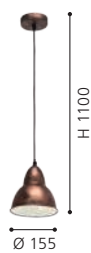

### 49492 PRIDDY 1

pendant light; steel, antique copper coloured  
Hängeleuchte; Stahl, kupferfarben-antik  
luminaire en suspension; acier, cuivré antique

H 1100, Ø 155



E27 1x 40W



9 002759 494926

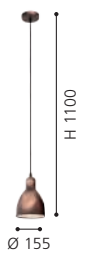



49248

### 49248 TRURO 2

pendant light; steel, antique copper coloured  
Hängeleuchte; Stahl, kupferfarben-antik  
luminaire en suspension; acier, cuivré antique

H 1100, Ø 370



E27



1x 60W



9 002759 492489



DESIGN  
HIGHLIGHT  
DETAIL





43878



49464

### 43878 PRIDDY

pendant light; steel, black, white  
 Hängeleuchte; Stahl, schwarz, weiss  
 luminaire en suspension; acier, noir, blanc

H 1100, Ø 305



E27



1x 40W



9 002759 438784



### 49464 PRIDDY

pendant light; steel, black, white  
 Hängeleuchte; Stahl, schwarz, weiss  
 luminaire en suspension; acier, noir, blanc

H 1100, Ø 155



E27



1x 40W



9 002759 494643

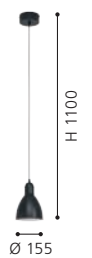

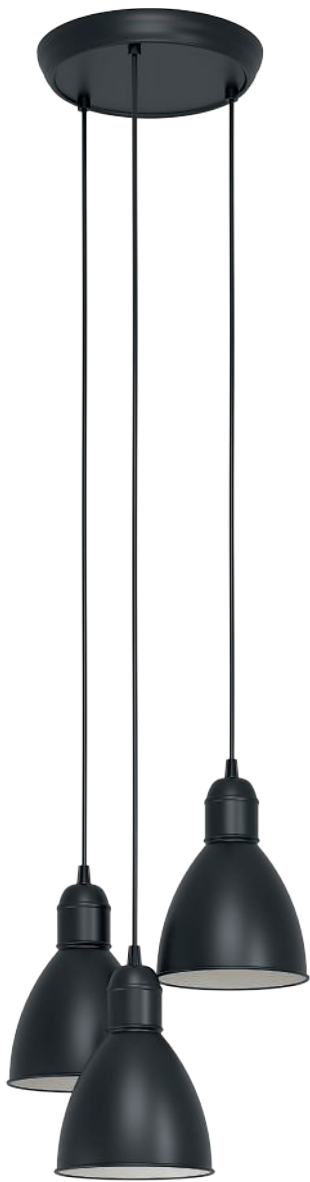

49465



49466

### 49465 PRIDDY

pendant light; steel, black, white  
 Hängeleuchte; Stahl, schwarz, weiss  
 luminaire en suspension; acier, noir, blanc

H 1100, Ø 325



E27



3x 40W



9 002759 494650

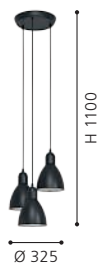

### 49466 PRIDDY

pendant light; steel, black, white  
 Hängeleuchte; Stahl, schwarz, weiss  
 luminaire en suspension; acier, noir, blanc

L 975, B 155, H 1100



E27



4x 40W



9 002759 494667





49468



49469

### 49468 PRIDDY

wall light; steel, black, white  
Wandleuchte; Stahl, schwarz, weiss  
Applique; acier, noir, blanc

L 130, H 215, A 200



E27 1x 40W



9 002759 494681



### 49469 PRIDDY

table light; steel, black, white  
Tischleuchte; Stahl, schwarz, weiss  
luminaire de table; acier, noir, blanc

H 425, Base: Ø 155



E27 1x 40W



9 002759 494698



### 49471 PRIDDY

floor light; steel, black, white  
Stehleuchte; Stahl, schwarz, weiss  
lampadaire; acier, noir, blanc

H 1370, Base: Ø 230

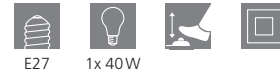

E27 1x 40W



9 002759 494711

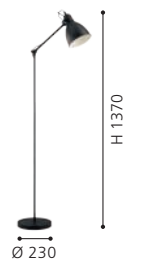





49471



#### DETAIL 43184

The luminaires can be individually extended by the movable and extendable arms.

Die Leuchten können durch die beweglichen und ausziehbaren Arme individuell verlängert werden.

Les luminaires peuvent être rallongés individuellement grâce aux bras mobiles et extensibles.



#### 43184 TREBURLEY

wall light; steel, black, gold  
Wandleuchte; Stahl, schwarz, gold  
Applique; acier, noir, or

L 155, B 650, H 200



E27 1x 28W



9 002759 431846



#### 49617 COVALEDA

table light; wood, steel, black, brass, gold  
Tischleuchte; Holz, Stahl, schwarz, messing, gold  
luminaire de table; bois, acier, noir, laiton, or

H 735, Ø 380



E27 1x 60W



9 002759 496173



#### 49618 COVALEDA

floor light; wood, steel, black, brass, gold  
Stehleuchte; Holz, Stahl, schwarz, messing, gold  
lampadaire; bois, acier, noir, laiton, or

H 1640, Ø 550



E27 1x 60W



9 002759 496180

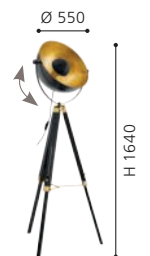



49617



49618



DESIGN  
HIGHLIGHT  
DETAIL



49761

#### 49761 EMBLETON

pendant light; steel, black  
Hängeleuchte; Stahl, schwarz  
luminaire en suspension; acier, noir

H 1100, Ø 305



E27 1x 60W



9 002759 497613

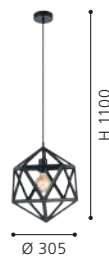

#### 49762 EMBLETON

pendant light; steel, black  
Hängeleuchte; Stahl, schwarz  
luminaire en suspension; acier, noir

H 1500, Ø 460



E27 1x 60W



9 002759 497620

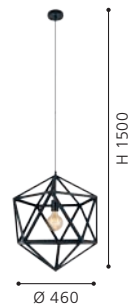



49762



#### DETAIL MARDYKE

This luminaire series has a unique look with the mixture of steel and clear glass.

Diese Leuchtenserie verfügt mit der Mischung aus Stahl und Klarglas über eine einzigartige Optik.

Cette série de luminaires a un look unique avec le mélange d'acier et de verre transparent.

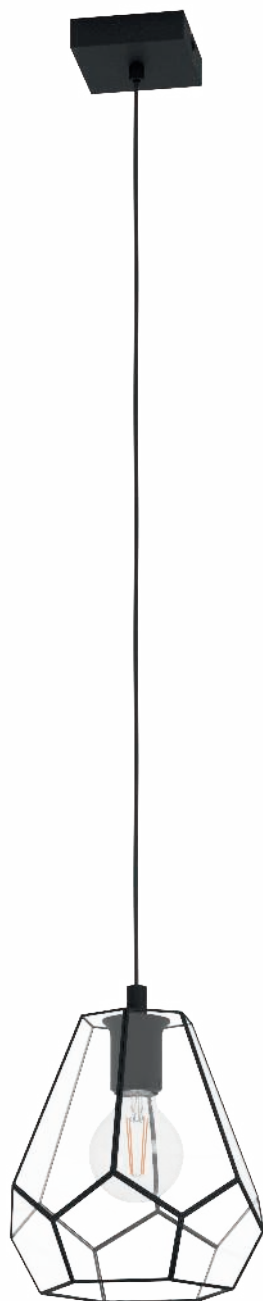

43643



43645



43646

#### 43643 MARDYKE

pendant light; steel, black / glass, clear  
Hängeleuchte; Stahl, schwarz / Glas, klar  
luminaire en suspension; acier, noir / verre, transparent

H 1100, Ø 230



E27



1x 40W



9 002759 436438



#### 43645 MARDYKE

wall light; steel, black / glass, clear  
Wandleuchte; Stahl, schwarz / Glas, klar  
Applique; acier, noir / verre, transparent

L 145, H 205, A 195



E27



1x 40W



9 002759 436452

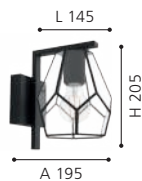

#### 43646 MARDYKE

table light; steel, black / glass, clear  
Tischleuchte; Stahl, schwarz / Glas, klar  
luminaire de table; acier, noir / verre, transparent

L 190, B 150, H 505, Base: B 188, T 128



E27



1x 40W



9 002759 436469





43644

### 43644 MARDYKE

pendant light; steel, black / glass, clear

Hängeleuchte; Stahl, schwarz / Glas, klar

luminaire en suspension; acier, noir / verre, transparent

L 775, B 145, H 1100



E27



3x 40W



9 002759 436445

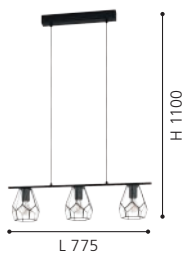

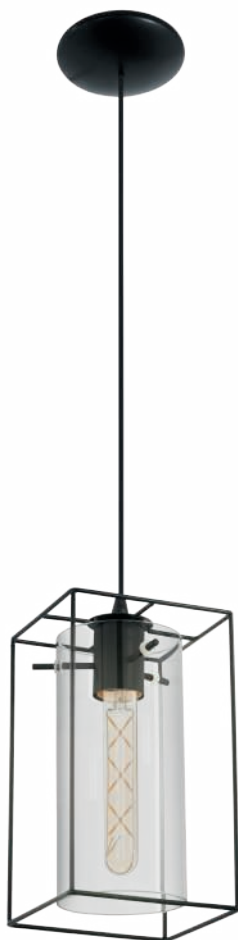

49495



49496

### 49495 LONCINO

pendant light; steel, black / smoked glass, black-transparent  
 Hängeleuchte; Stahl, schwarz / Rauchglas, schwarz-transparent  
 luminaire en suspension; acier, noir / verre fumé, noir transparent

L 150, B 150, H 1100



E27 1x 60W



9 002759 494957

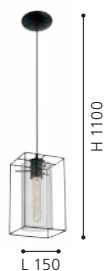

### 49496 LONCINO

pendant light; steel, black / smoked glass, black-transparent  
 Hängeleuchte; Stahl, schwarz / Rauchglas, schwarz-transparent  
 luminaire en suspension; acier, noir / verre fumé, noir transparent

L 745, B 150, H 1100



E27 3x 60W



9 002759 494964







49392



49394



49393

### 49392 CHARTERHOUSE

ceiling light; steel, black / glass, clear  
Deckenleuchte; Stahl, schwarz / Glas, klar  
plafonnier; acier, noir / verre, transparent

L 360, B 360, H 160



E27



2x 60W



9 002759 493929

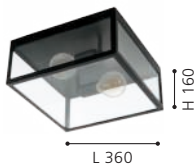

### 49394 CHARTERHOUSE

wall light; steel, black / glass, clear  
Wandleuchte; Stahl, schwarz / Glas, klar  
Applique; acier, noir / verre, transparent

L 160, H 280, A 150



E27



1x 60W



9 002759 493943

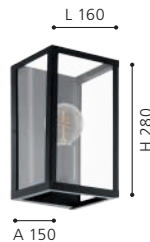

### 49393 CHARTERHOUSE

pendant light; steel, black / glass, clear  
Hängeleuchte; Stahl, schwarz / Glas, klar  
luminaire en suspension; acier, noir / verre, transparent

L 730, B 200, H 1100



E27



3x 60W



9 002759 493936





49564

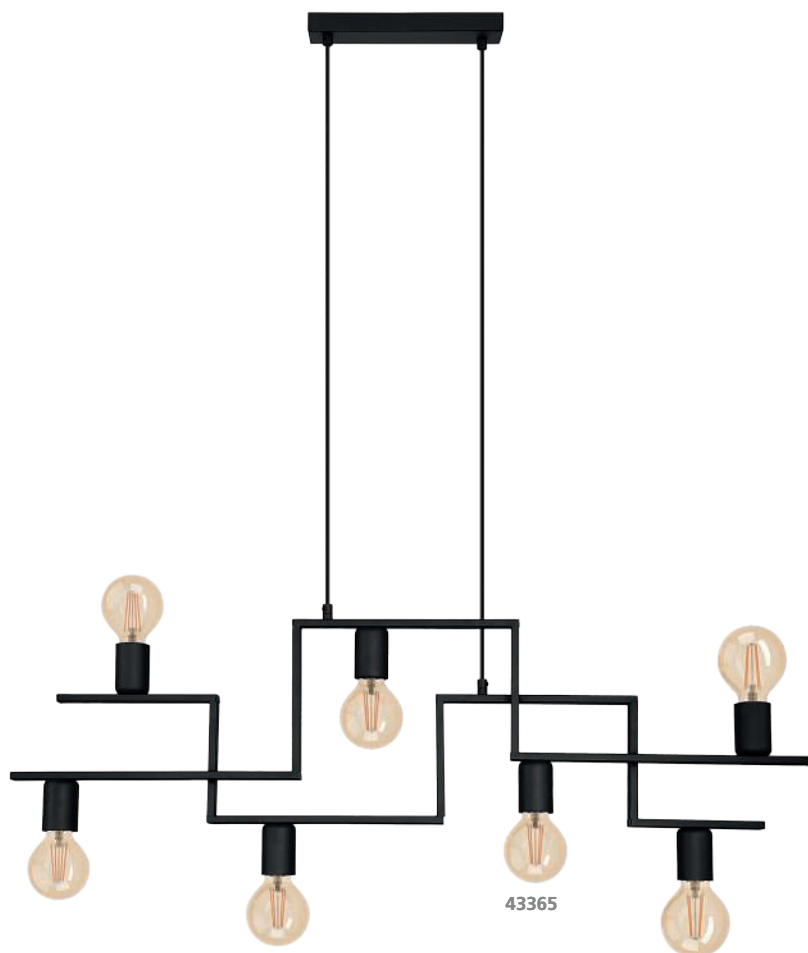

43365

### 49564 ELSWICK

pendant light; steel, black  
Hängeleuchte; Stahl, schwarz  
luminaire en suspension; acier, noir

L 1100, B 250, H 1500



E27 3x 60W



9 002759 495640



### 43365 FEMBAR

pendant light; steel, black  
Hängeleuchte; Stahl, schwarz  
luminaire en suspension; acier, noir

L 1005, B 40, H 1100



E27 7x 60W



9 002759 433659

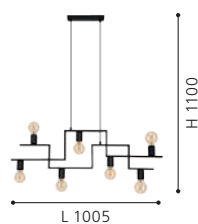

### 43126 WILMCOTE

ceiling light; steel, black  
Deckenleuchte; Stahl, schwarz  
plafonnier; acier, noir

H 380, Ø 280



E27 3x 60W



9 002759 431266





43126



49684



49685

### 49684 OLDBURY

pendant light; steel, wood, black, brown rustic  
 Hängeleuchte; Stahl, Holz, schwarz, braun rustikal  
 luminaire en suspension; acier, bois, noir, marron rustique

L 860, B 260, H 1100



E27



2x 60W



9 002759 496845



### 49685 OLDBURY

pendant light; steel, wood, black, brown rustic  
 Hängeleuchte; Stahl, Holz, schwarz, braun rustikal  
 luminaire en suspension; acier, bois, noir, marron rustique

L 1180, B 260, H 1100



E27



3x 60W



9 002759 496852





43522

DESIGN  
HIGHLIGHT  
DETAIL



43152

### 43522 TOWNSHEND 4

ceiling light; steel, antique brown  
Deckenleuchte; Stahl, antik-braun  
plafonnier; acier, marron antique

L 550, B 140, H 260



E27



3x 60W



9 002759 435226



### 43152 TOWNSHEND 4

wall light; steel, black, brown  
Wandleuchte; Stahl, schwarz, braun  
Applique; acier, noir, marron

L 80, H 190, A 185



E27



1x 10W



9 002759 431525





43523



43524

#### DETAIL TOWNSHEND 4

Thanks to the long cable of the luminaire heads the height can be adjusted individually.

Durch das lange Kabel der Leuchtenköpfe kann die Höhe individuell eingestellt werden.

Grâce au long câble des têtes de luminaire la hauteur peut être réglée individuellement.



#### 43523 TOWNSHEND 4

pendant light; steel, antique brown, black  
Hängeleuchte; Stahl, antik-braun, schwarz  
luminaire en suspension; acier, marron antique, noir

L 700, B 140, H 1100



E27



4x 60W



9 002759 435233



#### 43524 TOWNSHEND 4

pendant light; steel, antique brown, black  
Hängeleuchte; Stahl, antik-braun, schwarz  
luminaire en suspension; acier, marron antique, noir

L 1500, B 140, H 1100



E27



8x 60W



9 002759 435240

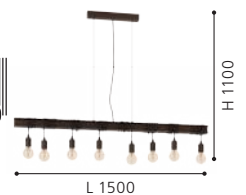



49859



43526



43525

### 49859 TOWNSHEND 4

pendant light; steel, antique brown, black  
 Hängeleuchte; Stahl, antik-braun, schwarz  
 luminaire en suspension; acier, marron antique, noir

L 1005, B 70, H 1100



E27



6x 60W



9 002759 498597

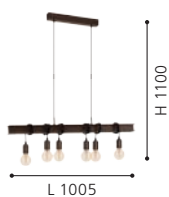

### 43526 TOWNSHEND 4

floor light; steel, antique brown, black  
 Stehleuchte; Stahl, antik-braun, schwarz  
 lampadaire; acier, marron antique, noir

L 260, B 250, H 1690, Base: Ø 250



E27



2x 10W



9 002759 435264



### 43525 TOWNSHEND 4

table light; steel, antique brown, black  
 Tischleuchte; Stahl, antik-braun, schwarz  
 luminaire de table; acier, marron antique, noir

L 165, B 155, H 500, Base: Ø 155



E27



1x 10W



9 002759 435257





43733



### 43733 PRESTWICK 2

table light; wood, brown  
Tischleuchte; Holz, braun  
luminaire de table; bois, marron

L 95, B 95, H 95



E27



1x 40W



9 002759 437336







43549



43548



43734



### 43548 PRESTWICK 1

table light; steel, auburn  
Tischleuchte; Stahl, rostbraun  
luminaire de table; acier, brun rouille

L 100, B 100, H 100



E27 1x 40W



9 002759 435486

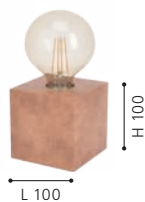

### 43549 PRESTWICK 2

table light; steel, dark bronze  
Tischleuchte; Stahl, bronze dunkel  
luminaire de table; acier, bronze foncé

L 100, B 100, H 100



E27 1x 40W



9 002759 435493



### 43734 PRESTWICK 2

table light; wood, black  
Tischleuchte; Holz, schwarz  
luminaire de table; bois, noir

L 95, B 95, H 95



E27 1x 40W



9 002759 437343





49076



49078

### 49076 GATEBECK

spot; wood, natural / steel, black  
Spot; Holz, natur / Stahl, schwarz  
spot; bois, naturel / acier, noir

L 110, B 110, H 205



E14 1x 40W



9 002759 490768



### 49078 GATEBECK

spot; wood, natural / steel, black  
Spot; Holz, natur / Stahl, schwarz  
spot; bois, naturel / acier, noir

L 590, B 110, H 205

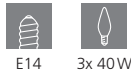

E14 3x 40W



9 002759 490782



### 49077 GATEBECK

spot; wood, natural / steel, black  
Spot; Holz, natur / Stahl, schwarz  
spot; bois, naturel / acier, noir

L 360, B 110, H 205

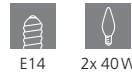

E14 2x 40W



9 002759 490775

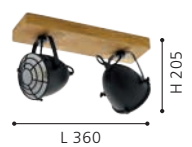



49077





43956



### 43956 MACCLES

pendant light; steel, wood, black, brown  
Hängeleuchte; Stahl, Holz, schwarz, braun  
luminaire en suspension; acier, bois, noir, marron

L 780, B 180, H 1100



E27



3x 15W



9 002759 439569

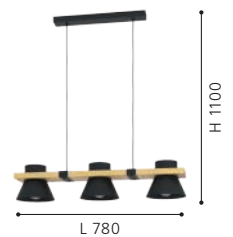



43955



43958



43959



### 43955 MACCLES

ceiling light; steel, wood, black, brown  
Deckenleuchte; Stahl, Holz, schwarz, braun  
plafonnier; acier, bois, noir, marron

L 780, B 180, H 205



E27



3x 15W



9 002759 439552



### 43958 MACCLES

wall light; steel, wood, black, brown  
Wandleuchte; Stahl, Holz, schwarz, braun  
Applique; acier, bois, noir, marron

L 180, H 150, A 200



E27



1x 15W



9 002759 439583



### 43959 MACCLES

table light; steel, wood, black, brown  
Tischleuchte; Stahl, Holz, schwarz, braun  
luminaire de table; acier, bois, noir, marron

H 150, Ø 180, Base: B 160, T 160



E27



1x 15W



9 002759 439590

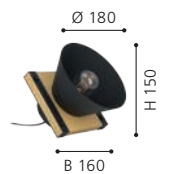



43953



43948



43949

### 43953 CAWTON

table light; steel, wood, steel coloured, rustic brown  
Tischleuchte; Stahl, Holz, stahlfarben, braun rustikal  
luminaire de table; acier, bois, couleur acier, marron rustique

L 240, B 160, H 380, Base: Ø 180



E27 1x 40W



9 002759 439538

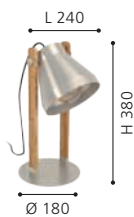

### 43948 CAWTON

spot; steel, wood, steel coloured, rustic brown  
Spot; Stahl, Holz, stahlfarben, braun rustikal  
spot; acier, bois, couleur acier, marron rustique

L 160, H 195, A 300



E27 1x 40W



9 002759 439484

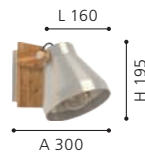

### 43949 CAWTON

spot; steel, wood, steel coloured, rustic brown  
Spot; Stahl, Holz, stahlfarben, braun rustikal  
spot; acier, bois, couleur acier, marron rustique

L 585, B 160, H 250



E27 2x 40W



9 002759 439491





43954



43951



43952

### 43954 CAWTON

floor light; steel, wood, steel coloured, rustic brown  
 Stehleuchte; Stahl, Holz, stahlfarben, braun rustikal  
 lampadaire; acier, bois, couleur acier, marron rustique

L 290, B 160, H 1345, Base: Ø 230



E27 2x 40W

L 290



H 1345

Ø 230



9 002759 439545

### 43951 CAWTON

pendant light; steel, wood, steel coloured, rustic brown  
 Hängeleuchte; Stahl, Holz, stahlfarben, braun rustikal  
 luminaire en suspension; acier, bois, couleur acier, marron rustique

H 1100, Ø 160



E27 1x 40W

H 1100



Ø 160



9 002759 439514

### 43952 CAWTON

pendant light; steel, wood, steel coloured, rustic brown  
 Hängeleuchte; Stahl, Holz, stahlfarben, braun rustikal  
 luminaire en suspension; acier, bois, couleur acier, marron rustique

L 760, B 160, H 1100



E27 3x 40W

H 1100



L 760



9 002759 439521

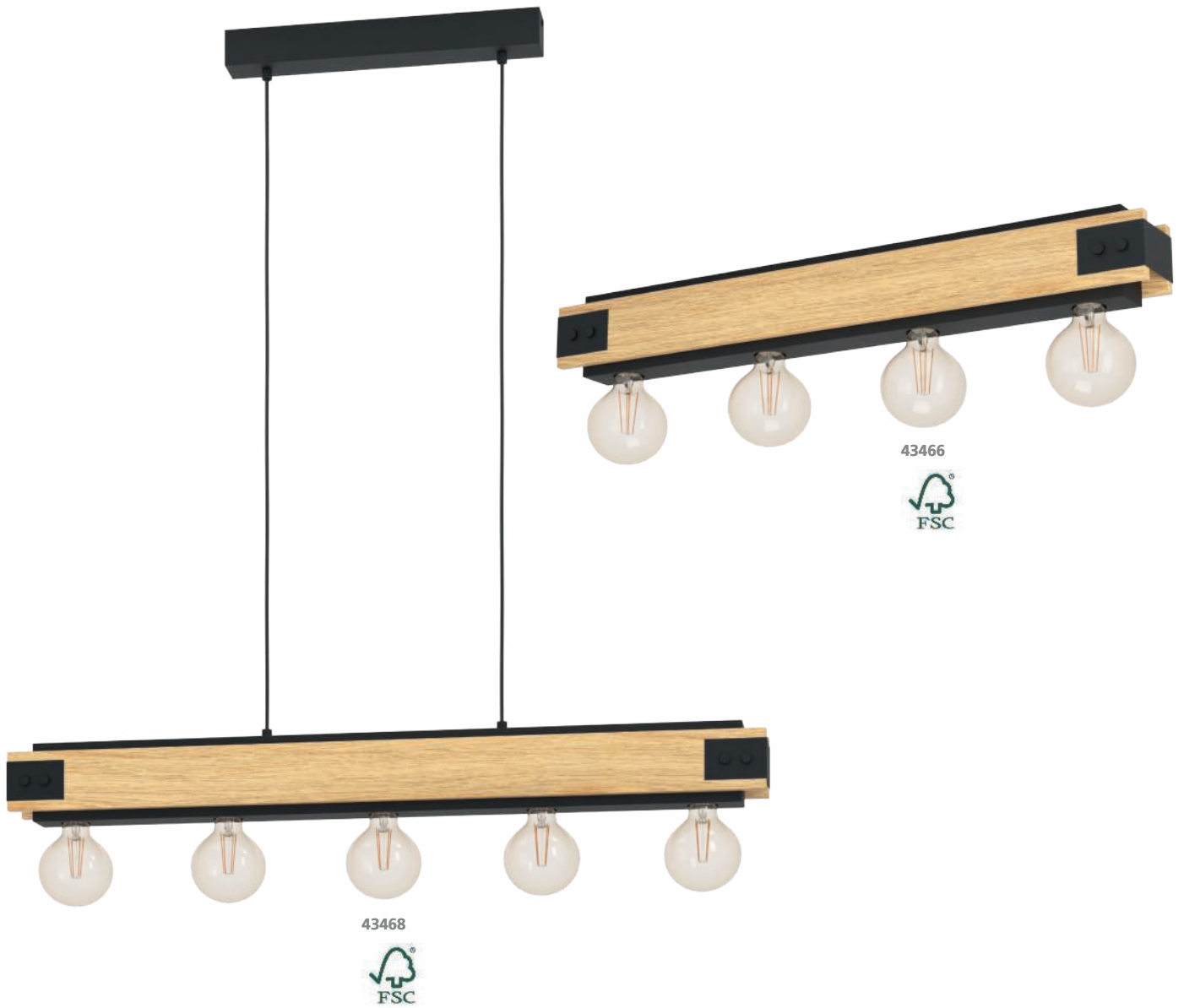

### 43468 LAYHAM

pendant light; wood, steel, brown, black  
 Hängeleuchte; Holz, Stahl, braun, schwarz  
 luminaire en suspension; bois, acier, marron, noir

L 960, B 85, H 1100



9 002759 434687

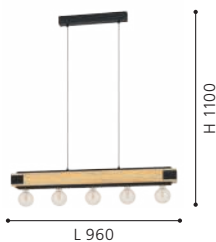

### 43466 LAYHAM

ceiling light; wood, steel, brown, black  
 Deckenleuchte; Holz, Stahl, braun, schwarz  
 plafonnier; bois, acier, marron, noir

L 760, B 85, H 100



9 002759 434663

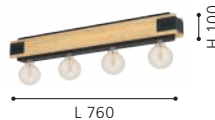

### 43469 LAYHAM

table light; wood, steel, brown, black  
 Tischleuchte; Holz, Stahl, braun, schwarz  
 luminaire de table; bois, acier, marron, noir

L 200, B 85, H 100

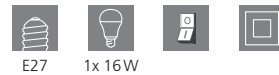

9 002759 434694

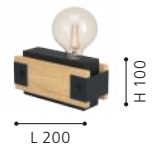





43469



### 43471 LAYHAM

floor light; wood, steel, brown, black  
 Stehleuchte; Holz, Stahl, braun, schwarz  
 lampadaire; bois, acier, marron, noir

H 1275, Base: B 260, T 245



E27



4x 60W

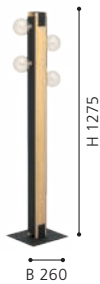

9 002759 434717

43471





43159



43805

### 43159 HARBOROUGH

pendant light; steel, black / wood, brown  
 Hängeleuchte; Stahl, schwarz / Holz, braun  
 luminaire en suspension; acier, noir / bois, marron

L 900, B 125, H 1100



E27



4x 40W



9 002759 431594

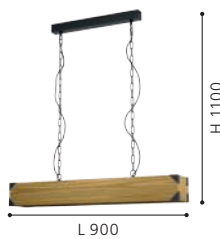

### 43805 EVESHAM

pendant light; steel, wood, black, brown  
 Hängeleuchte; Stahl, Holz, schwarz, braun  
 luminaire en suspension; acier, bois, noir, marron

L 895, B 195, H 1100



E27



3x 40W



9 002759 438050

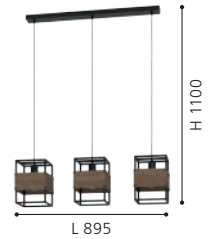



43804



43807



43806



### 43804 EVESHAM

ceiling light; steel, wood, black, brown  
Deckenleuchte; Stahl, Holz, schwarz, braun  
plafonnier; acier, bois, noir, marron

L 875, B 195, H 250



E27



3x 40W



9 002759 438043



L 875

H 250

### 43807 EVESHAM

table light; steel, wood, black, brown  
Tischleuchte; Stahl, Holz, schwarz, braun  
luminaire de table; acier, bois, noir, marron

L 195, B 195, H 250



E27



1x 40W



9 002759 438074



L 195

H 250

### 43806 EVESHAM

wall light; steel, wood, black, brown  
Wandleuchte; Stahl, Holz, schwarz, braun  
Applique; acier, bois, noir, marron

L 140, H 240, A 170



E27



1x 40W



9 002759 438067



A 170

H 240



43832



43834

### 43832 KILNSDALE

ceiling light; steel, wood, black, brown  
Deckenleuchte; Stahl, Holz, schwarz, braun  
plafonnier; acier, bois, noir, marron

H 240, Ø 380



E27 1x 40W



9 002759 438326

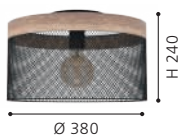

### 43834 KILNSDALE

pendant light; steel, wood, black, brown  
Hängeleuchte; Stahl, Holz, schwarz, braun  
luminaire en suspension; acier, bois, noir, marron

L 810, B 110, H 1100



E27 3x 40W



9 002759 438340

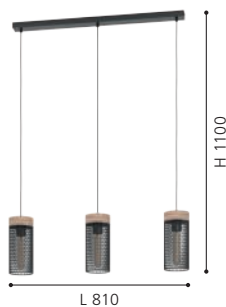

### 43833 KILNSDALE

pendant light; steel, wood, black, brown  
Hängeleuchte; Stahl, Holz, schwarz, braun  
luminaire en suspension; acier, bois, noir, marron

H 1100, Ø 110



E27 1x 40W



9 002759 438333





43833

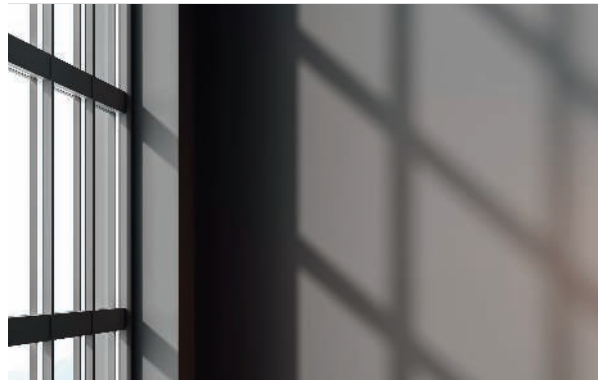
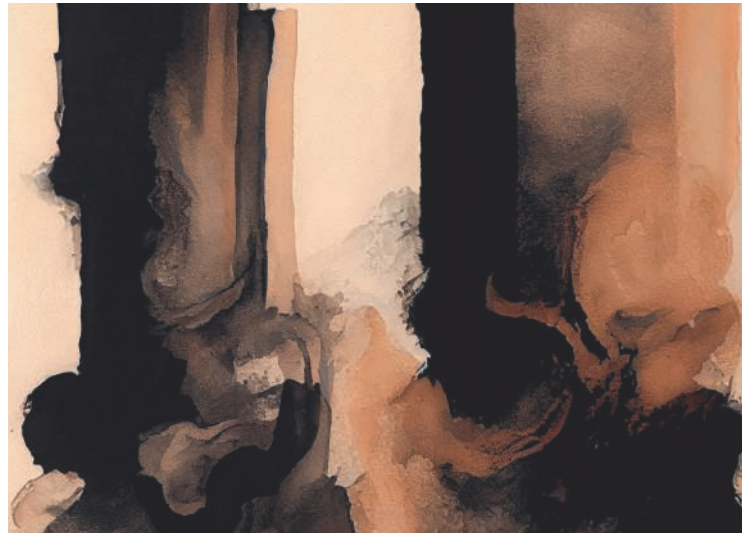







# LOFT

#COSY  
#CLEAR

Separate rooms and designated spaces for working, eating and leisure are a thing of the past. Free spirits need open spaces. The loft design imparts a sense of freedom and tranquillity, and the minimalist furnishings and accessories ensure your space still feels cosy and liveable. Simple yet sophisticated. Clean lines and dark surfaces offset by brighter accents are the main features of the loft aesthetic. Recreate this chic look in your own home with EGLO.

Die Zeiten in denen Wohnen, Essen und Arbeiten in getrennten Räumen stattfanden, sind vorbei. Freigeister brauchen Freiräume, um sich wohl zu fühlen. Der Loft-Look steht für Freiheit und Gelassenheit, welcher durch minimalistische Möbel und Accessoires trotzdem gemütliches Raumgefühl gibt. Einfach und doch raffiniert. Klare Linien, dunkle Oberflächen, kontrastiert von hellen Akzenten sind die Hauptmerkmale des Loft-Looks und mit EGLO holen Sie sich diesen Loft-Charm ganz einfach nach Hause.

Finie l'époque où l'on vivait, mangeait et travaillait dans des pièces distinctes ! Les esprits libres ont besoin d'espace pour se sentir bien. Le style loft est synonyme de liberté et de sérénité, mais donne néanmoins le sentiment d'un espace chaleureux grâce à un mobilier et à des accessoires minimalistes. Simple, mais sophistiqué. Des lignes épurées avec des surfaces foncées, contrastées par des touches claires, sont les principales caractéristiques du style loft. Appropriiez-vous son élégance dans votre intérieur avec EGLO.

CHASELY 80 	HORNWOOD 2 81 	MADRESELVA 82 	BOYLE 82-83 	HORNWOOD 84-85 	LACEY 86-87 	BRAMERTON 88-89 	AYLES 89 
CHIEVELEY 90-91 	HALKIN 92 	CONSETT 92-93 	MONMOUNT 94 	FAMBOROUGH 94-95 	NAFFERTON 96-97 	LITTLETON 98-99 	IPSDEN 100 
BASILDON 1 100 	BASILDON 102-103 	CALLOW 104 	SHERBURN 105 	BAILRIGG 106-107 	TOWNSHEND 108-113 	TOWNSHEND 5 113-116 	PALMORLA 118 
DISTAFF 118 	CARLTON 1 120-122,126-128 	CARLTON 7 122-123 	CARLTON 4 124 	CARLTON 6 124 	CARLTON 5 125-126 	CARLTON-P 128-129 	CARLTON 130-133 
STYPE 134-135 	STRAITON 136,176 	VERNHAM 139 	TARBES 140,150-151,153-157 	CARLTON 2 140-141 	STILLINGTON 142-143 	STILLINGTON 1 144-145 	SOUTHERY 146-147 
CASTANUELO 148-149 	TARBES 2 152 	ROCCAMENA 158-159 	CLEVEDON 160 	NEWTOWN 162-163 	AUSTELL 164-165 	PLIMSOLL 167 	HORNWOOD 1 168 
GLASTONBURY 168 	LANTADA 171 	BIDFORD 171 	CHESTER 172 	DUNDEE 173 	CHESTER 1 173 	COPLEY 174-175 	

 This product is available in different colors and shapes./ Dieser Artikel ist in unterschiedlichen Farben und Formen verfügbar.  
Cet article est disponible en différentes couleurs et formes.



CORETTO 2  
177



HAPTON  
177



WRINGTON  
178-179



POMPEYA  
181



WRINGTON 1  
181



BAZELY  
183



SALLICANO  
183



TWICKEN  
184-185



MATLOCK  
186-189



PRESTWICK 3  
190-191



PRESTWICK  
192



LYNTON  
192



FRIJOLAS  
192



 This product is available in different colors and shapes./ Dieser Artikel ist in unterschiedlichen Farben und Formen verfügbar.  
Cet article est disponible en différentes couleurs et formes.







43459



43129

#### DETAIL CHASELY

The glass shade of this luminaires has a unique color gradient.

Der Glasschirm dieser Leuchten hat einen einzigartigen Farbverlauf.

L'abat-jour en verre de cette luminaires a un dégradé de couleurs unique.



#### 43459 CHASELY

pendant light; steel, black / glass, black-brown-transparent

Hängeleuchte; Stahl, schwarz / Glas, schwarz-braun-transparent

luminaire en suspension; acier, noir / verre, noir-marron-transparent

H 1100, Ø 200



E27

1x 40W



9 002759 434595



#### 43129 CHASELY

pendant light; steel, black / glass, black-grey-transparent

Hängeleuchte; Stahl, schwarz / Glas, schwarz-grau-transparent

luminaire en suspension; acier, noir / verre, noir-gris-transparent

H 1100, Ø 200



E27

1x 40W



9 002759 431297



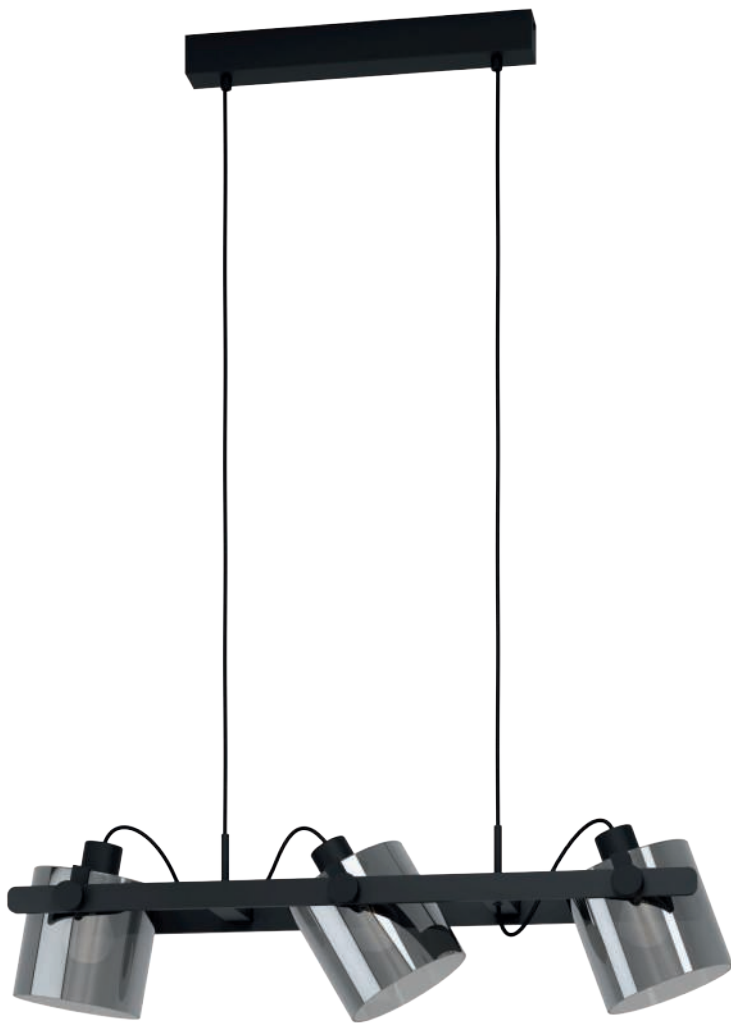

43606



43671



### 43606 HORNWOOD 2

pendant light; steel, wood, black / glass vaporized, black-transparent

Hängeleuchte; Stahl, Holz, schwarz / Glas bedampft, schwarz-transparent

luminaire en suspension; acier, bois, noir / verre vaporisé, noir transparent

L 780, B 150, H 1100



E27



3x 40W



9 002759 436063

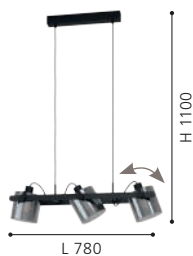

### 43671 HORNWOOD 2

ceiling light; steel, wood, black / glass vaporized, black-transparent

Deckenleuchte; Stahl, Holz, schwarz / Glas bedampft, schwarz-transparent

plafonnier; acier, bois, noir / verre vaporisé, noir transparent

L 1110, B 225, H 265



E27



4x 40W



9 002759 436711

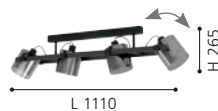

### DETAIL HORNWOOD 2

The heads of this luminaire can be swiveled individually.

Die Leuchtenköpfe sind individuell schwenkbar.

Les têtes de ce luminaire peuvent être pivotées individuellement.





43545

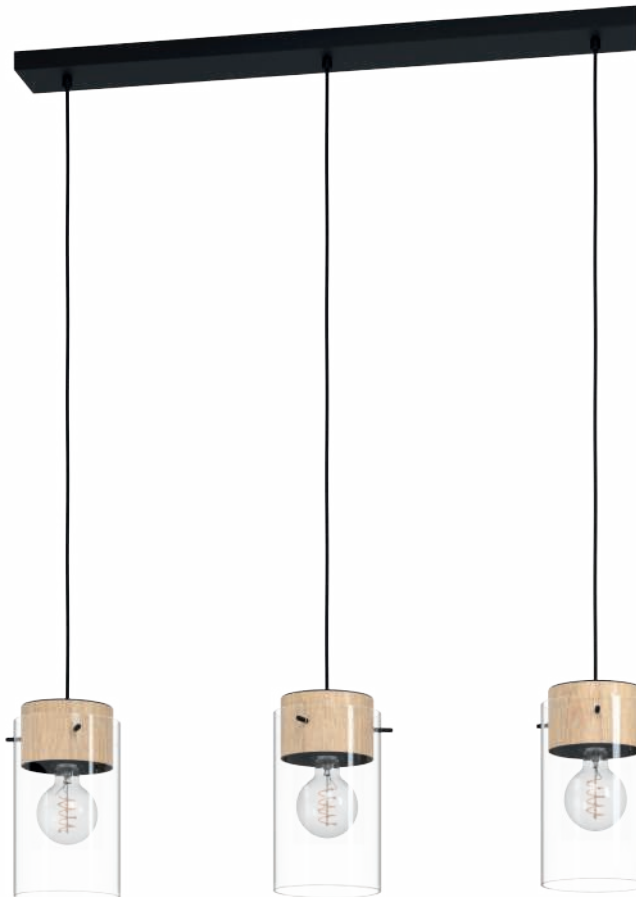

43546



43635



### 43545 MADRESELVA

pendant light; steel, black / wood, glass, brown, clear  
Hängeleuchte; Stahl, schwarz / Holz, Glas, braun, klar  
luminaire en suspension; acier, noir / bois, verre, marron, transparent

H 1100, Ø 140



E27 1x 28W



9 002759 435455



### 43546 MADRESELVA

pendant light; steel, black / wood, glass, brown, clear  
Hängeleuchte; Stahl, schwarz / Holz, Glas, braun, klar  
luminaire en suspension; acier, noir / bois, verre, marron, transparent

L 840, B 140, H 1100



E27 3x 28W



9 002759 435462



### 43635 BOYLE

ceiling light; steel, wood, black, brown / plastic, white  
Deckenleuchte; Stahl, Holz, schwarz, braun / Kunststoff, weiss  
plafonnier; acier, bois, noir, marron / plastique, blanc

L 780, B 170, H 300



E27 3x 10W



9 002759 436353





43636



### 43636 BOYLE

pendant light; steel, wood, black, brown / plastic, white  
Hängeleuchte; Stahl, Holz, schwarz, braun / Kunststoff, weiss  
luminaire en suspension; acier, bois, noir, marron / plastique, blanc

L 780, B 170, H 1100



E27



3x 10W



9 002759 436360





43045



43424



#### DETAIL HORNWOOD

The heads can be adjusted or fixed in position with the lateral screws.  
 Die Köpfe können mittels den seitlichen Schrauben verstellt oder fixiert werden.  
 Les têtes peuvent être réglées ou fixées à l'aide des vis latérales.



43046

#### 43045 HORNWOOD

pendant light; steel, black, creme / wood, brown  
 Hängeleuchte; Stahl, schwarz, creme / Holz, braun  
 luminaire en suspension; acier, noir, crème / bois, marron

L 780, B 210, H 1100



E27 3x 60W



9 002759 430450

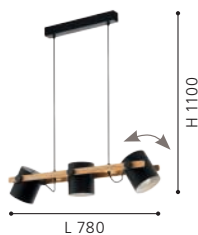

#### 43424 HORNWOOD

pendant light; steel, black, creme / wood, brown  
 Hängeleuchte; Stahl, schwarz, creme / Holz, braun  
 luminaire en suspension; acier, noir, crème / bois, marron

L 1100, B 180, H 1100



E27 4x 28W



9 002759 434243

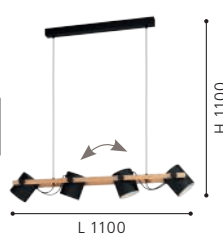

#### 43046 HORNWOOD

wall light; steel, black, creme / wood, brown  
 Wandleuchte; Stahl, schwarz, creme / Holz, braun  
 Applique; acier, noir, crème / bois, marron

Ø 170



E27 1x 28W



9 002759 430467





43558



43047



43048

### 43558 HORNWOOD

ceiling light; steel, black, creme / wood, brown  
Deckenleuchte; Stahl, schwarz, creme / Holz, braun  
plafonnier; acier, noir, crème / bois, marron

L 1000, B 190, H 275



E27



4x 28W



9 002759 435585

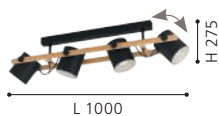

### 43047 HORNWOOD

table light; steel, black, creme / wood, brown  
Tischleuchte; Stahl, schwarz, creme / Holz, braun  
luminaire de table; acier, noir, crème / bois, marron

L 210, B 180, H 420, Base: Ø 180



E27



1x 28W



9 002759 430474



### 43048 HORNWOOD

floor light; steel, black, creme / wood, brown  
Stehleuchte; Stahl, schwarz, creme / Holz, braun  
lampadaire; acier, noir, crème / bois, marron

L 230, B 230, H 1400, Base: Ø 230



E27



1x 28W



9 002759 430481





43735

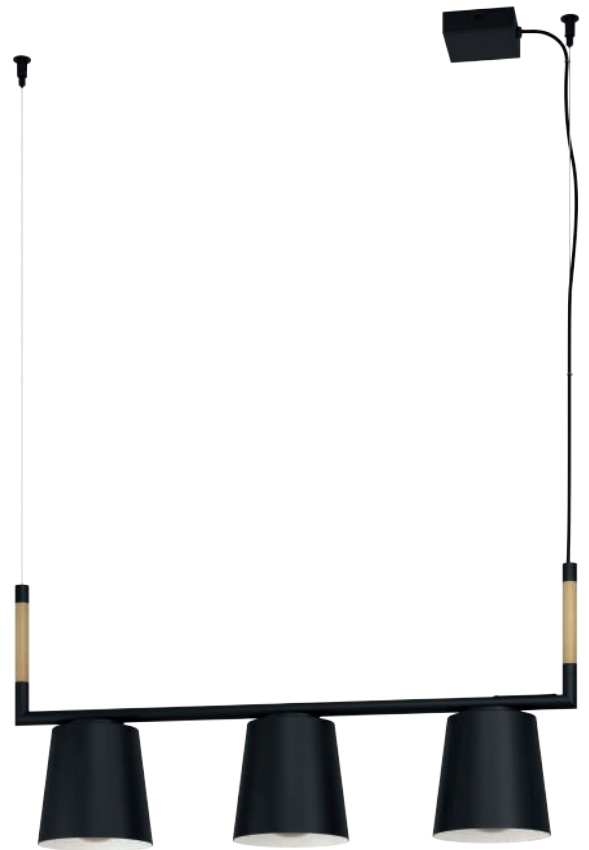

43612



#### DETAIL LACEY

This luminaire has design elements made of real wood.

Diese Leuchte verfügt über Design-elemente aus Echtholz.

Cette luminaire a des éléments de design en bois véritable.

#### 43735 LACEY

wall light; steel, wood, black, brown / steel, black, creme  
Wandleuchte; Stahl, Holz, schwarz, braun / Stahl, schwarz, creme

Applique; acier, bois, noir, marron / acier, noir, crème

L 135, H 275, A 265



E14



1x 40W



9 002759 437350



#### 43612 LACEY

pendant light; steel, wood, black, brown / steel, black, creme  
Hängeleuchte; Stahl, Holz, schwarz, braun / Stahl, schwarz, creme

luminaire en suspension; acier, bois, noir, marron / acier, noir, crème

L 780, B 160, H 1100



E27



3x 40W



9 002759 436124







43611



43613



43614



### 43611 LACEY

ceiling light; steel, wood, black, brown / steel, black, creme  
Deckenleuchte; Stahl, Holz, schwarz, braun / Stahl, schwarz, creme  
plafonnier; acier, bois, noir, marron / acier, noir, crème

L 780, B 160, H 335



E27



3x 40W



9 002759 436117



### 43613 LACEY

table light; steel, wood, black, brown / steel, black, creme  
Tischleuchte; Stahl, Holz, schwarz, braun / Stahl, schwarz, creme  
luminaire de table; acier, bois, noir, marron / acier, noir, crème

L 255, B 135, H 485, Base: B 170, T 120



E14



1x 40W



9 002759 436131



### 43614 LACEY

floor light; steel, wood, black, brown / steel, black, creme  
Stehleuchte; Stahl, Holz, schwarz, braun / Stahl, schwarz, creme  
lampadaire; acier, bois, noir, marron / acier, noir, crème

L 310, B 160, H 1595, Base: B 280, T 200



E27



1x 40W



9 002759 436148





### 43752 BRAMERTON

pendant light; steel, wood, black, brown  
 Hängeleuchte; Stahl, Holz, schwarz, braun  
 luminaire en suspension; acier, bois, noir, marron

L 810, B 120, H 1100

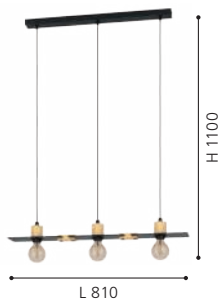

### 43751 BRAMERTON

ceiling light; steel, wood, black, brown  
 Deckenleuchte; Stahl, Holz, schwarz, braun  
 plafonnier; acier, bois, noir, marron

L 810, B 120, H 100



### 43753 BRAMERTON

wall light; steel, wood, black, brown  
 Wandleuchte; Stahl, Holz, schwarz, braun  
 Applique; acier, bois, noir, marron

L 120, H 110, A 215

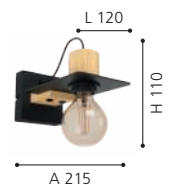



43749

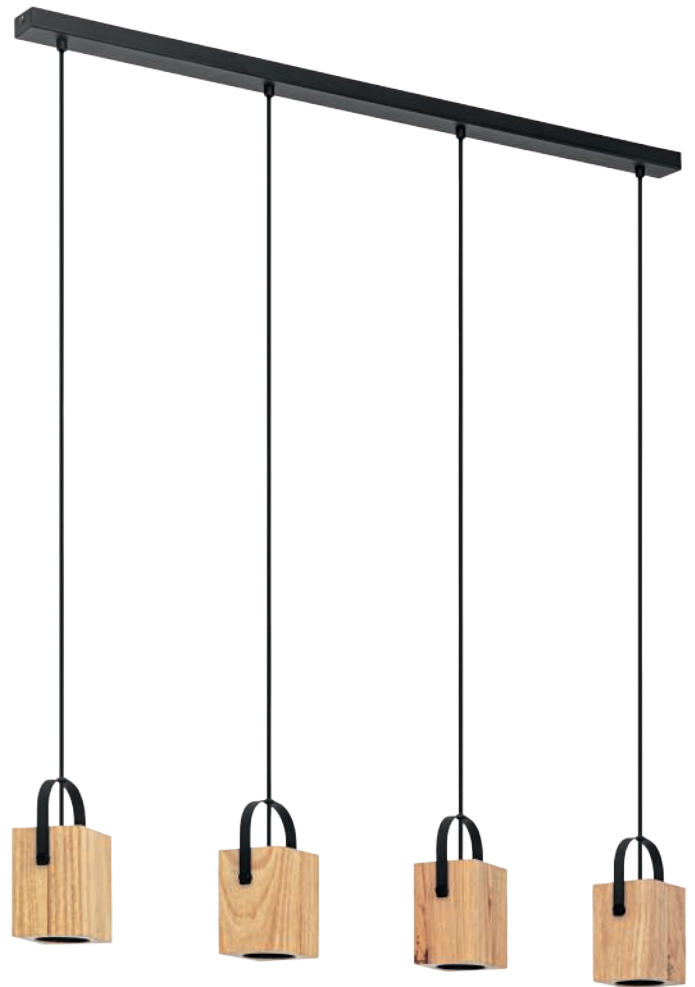

43748



43754



### 43754 BRAMERTON

table light; steel, wood, black, brown  
Tischleuchte; Stahl, Holz, schwarz, braun  
luminaire de table; acier, bois, noir, marron

L 120, B 140, H 310, Base: B 120, T 140



E27



1x 40W



9 002759 437541

### 43749 AYLES

table light; steel, black / wood, brown  
Tischleuchte; Stahl, schwarz / Holz, braun  
luminaire de table; acier, noir / bois, marron

H 475, Base: Ø 260



GU10



1x 3W



1x  
250lm



9 002759 437497



### 43748 AYLES

pendant light; steel, black / wood, brown  
Hängeleuchte; Stahl, schwarz / Holz, braun  
luminaire en suspension; acier, noir / bois, marron

L 930, B 85, H 1100



GU10



4x 3W



4x  
250lm



9 002759 437480





43541



DESIGN  
HIGHLIGHT  
DETAIL

### 43541 CHIEVELEY

pendant light; steel, black / wood, brown  
Hängeleuchte; Stahl, schwarz / Holz, braun  
luminaire en suspension; acier, noir / bois, marron

L 885, B 85, H 1100



E27



5x 40W



9 002759 435417

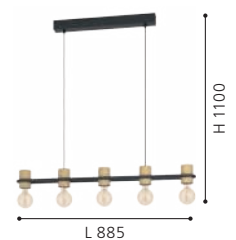



43542



43543



43544



### 43542 CHIEVELEY

wall light; steel, black / wood, brown  
Wandleuchte; Stahl, schwarz / Holz, braun  
Applique; acier, noir / bois, marron

L 285, H 90, A 115



E27



2x 40W



9 002759 435424

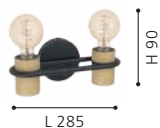

### 43543 CHIEVELEY

table light; steel, black / wood, brown  
Tischleuchte; Stahl, schwarz / Holz, braun  
luminaire de table; acier, noir / bois, marron

L 85, B 90, H 410, Base: Ø 155



E27



1x 28W



9 002759 435431



### 43544 CHIEVELEY

floor light; steel, black / wood, brown  
Stehleuchte; Stahl, schwarz / Holz, braun  
lampadaire; acier, noir / bois, marron

L 85, B 90, H 1405, Base: Ø 230



E27



3x 28W



9 002759 435448

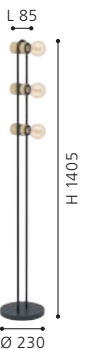



### 43799 HALKIN

pendant light; wood, steel, brown, black  
 Hängeleuchte; Holz, Stahl, braun, schwarz  
 luminaire en suspension; bois, acier, marron, noir

L 720, B 250, H 1100

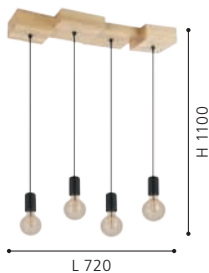

### 43798 HALKIN

ceiling light; wood, steel, brown, black  
 Deckenleuchte; Holz, Stahl, braun, schwarz  
 plafonnier; bois, acier, marron, noir

L 400, B 430, H 140

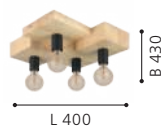

### 43724 CONSETT

ceiling light; steel, wood, black, brown  
 Deckenleuchte; Stahl, Holz, schwarz, braun  
 plafonnier; acier, bois, noir, marron

L 780, B 250, H 115

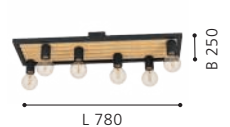



43725



### 43725 CONSETT

pendant light; steel, wood, black, brown  
Hängeleuchte; Stahl, Holz, schwarz, braun  
luminaire en suspension; acier, bois, noir, marron

L 780, B 250, H 1100



E27



6x 40W



9 002759 437251



H 1100

L 780



DESIGN  
HIGHLIGHT  
DETAIL



43641



43413



### 43641 MONMOUNT

pendant light; steel, wood, black, brown  
 Hängeleuchte; Stahl, Holz, schwarz, braun  
 luminaire en suspension; acier, bois, noir, marron

L 1085, B 445, H 850



E27



9x 40W



9 002759 436414

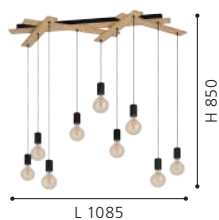

### 43413 FAMBOROUGH

pendant light; steel, wood, black, natural  
 Hängeleuchte; Stahl, Holz, schwarz, natur  
 luminaire en suspension; acier, bois, noir, naturel

L 160, B 105, H 1100



E27



1x 40W



9 002759 434137

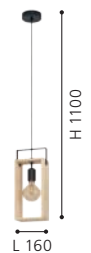





43414



43416



43415



### 43414 FAMBOROUGH

pendant light; steel, wood, black, natural  
Hängeleuchte; Stahl, Holz, schwarz, natur  
luminaire en suspension; acier, bois, noir, naturel

L 1000, B 160, H 1100



E27

5x 40W



9 002759 434144

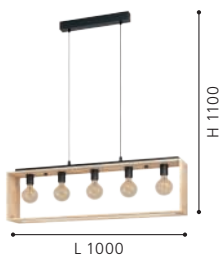

### 43416 FAMBOROUGH

table light; steel, wood, black, natural  
Tischleuchte; Stahl, Holz, schwarz, natur  
luminaire de table; acier, bois, noir, naturel

L 305, B 160, H 565, Base: B 300, T 160



E27

3x 40W



9 002759 434168



### 43415 FAMBOROUGH

table light; steel, wood, black, natural  
Tischleuchte; Stahl, Holz, schwarz, natur  
luminaire de table; acier, bois, noir, naturel

L 165, B 100, H 400, Base: B 160, T 100



E27

1x 40W



9 002759 434151





43744



### 43744 NAFFERTON

pendant light; steel, wood, black, brown  
Hängeleuchte; Stahl, Holz, schwarz, braun  
luminaire en suspension; acier, bois, noir, marron

L 800, B 100, H 1100



E27



3x 40W



9 002759 437442





43743



43746



43745



### 43743 NAFFERTON

pendant light; steel, wood, black, brown  
Hängeleuchte; Stahl, Holz, schwarz, braun  
luminaire en suspension; acier, bois, noir, marron

L 100, B 100, H 1100



E27



1x 40W



9 002759 437435



### 43746 NAFFERTON

table light; steel, wood, black, brown  
Tischleuchte; Stahl, Holz, schwarz, braun  
luminaire de table; acier, bois, noir, marron

L 100, B 100, H 280



E27



1x 40W



9 002759 437466



### 43745 NAFFERTON

wall light; steel, wood, black, brown  
Wandleuchte; Stahl, Holz, schwarz, braun  
Applique; acier, bois, noir, marron

L 100, H 280, A 125



E27



1x 40W



9 002759 437459

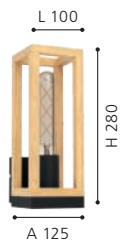



49473



49475

### 49473 LITTLETON

pendant light; steel, black / wood, brown  
Hängeleuchte; Stahl, schwarz / Holz, braun  
luminaire en suspension; acier, noir / bois, marron

L 110, B 100, H 1100



E27



1x 60W



9 002759 494735

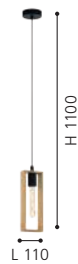

### 49475 LITTLETON

pendant light; steel, black / wood, brown  
Hängeleuchte; Stahl, schwarz / Holz, braun  
luminaire en suspension; acier, noir / bois, marron

L 1160, B 55, H 1100



E27



4x 60W



9 002759 494759





49698



49549

### 49698 LITTLETON

wall light; steel, black / wood, brown  
 Wandleuchte; Stahl, schwarz / Holz, braun  
 Applique; acier, noir / bois, marron

L 110, H 330, A 115



E27



1x 60W



9 002759 496982



### 49549 LITTLETON

pendant light; steel, black / wood, brown  
 Hängeleuchte; Stahl, schwarz / Holz, braun  
 luminaire en suspension; acier, noir / bois, marron

H 1500, Ø 500



E27



6x 60W



9 002759 495497





43551



43569



### 43551 IPSDEN

pendant light; steel, black / wood, brown  
 Hängeleuchte; Stahl, schwarz / Holz, braun  
 luminaire en suspension; acier, noir / bois, marron

H 1300, Ø 300



E27 3x 40W



9 002759 435516

### 43569 BASILDON 1

table light; steel, wood, black, brown / fabric, black  
 Tischleuchte; Stahl, Holz, schwarz, braun / Textil, schwarz  
 luminaire de table; acier, bois, noir, marron / tissu, noir

H 425, Ø 230, Base: Ø 150



E27 1x 40W



9 002759 435691

### 43552 IPSDEN

pendant light; steel, black / wood, brown  
 Hängeleuchte; Stahl, schwarz / Holz, braun  
 luminaire en suspension; acier, noir / bois, marron

L 1005, B 220, H 1100



E27 5x 40W

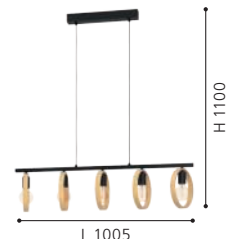

9 002759 435523



43552





#### DETAIL BASILDON

The black metal ring is individually adjustable.  
Der schwarze Metallring ist individuell verstellbar.  
L'anneau en métal noir est réglable individuellement.



43461



43462



#### 43461 BASILDON

pendant light; steel, wood, black, brown  
Hängeleuchte; Stahl, Holz, schwarz, braun  
luminaire en suspension; acier, bois, noir, marron

L 190, B 160, H 1100



E27 1x 40W



9 002759 434618

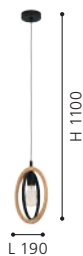

#### 43462 BASILDON

pendant light; steel, wood, black, brown  
Hängeleuchte; Stahl, Holz, schwarz, braun  
luminaire en suspension; acier, bois, noir, marron

L 780, B 160, H 1100



E27 3x 40W



9 002759 434625

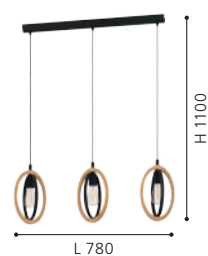





43736



43464



43463



### 43736 BASILDON

ceiling light; steel, wood, black, brown  
Deckenleuchte; Stahl, Holz, schwarz, braun  
plafonnier; acier, bois, noir, marron

H 375, Ø 320



E27



1x 40W



9 002759 437367

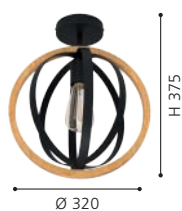

### 43464 BASILDON

table light; steel, wood, black, brown  
Tischleuchte; Stahl, Holz, schwarz, braun  
luminaire de table; acier, bois, noir, marron

L 190, B 160, H 345, Base: Ø 155



E27



1x 40W



9 002759 434649



### 43463 BASILDON

pendant light; steel, wood, black, brown  
Hängeleuchte; Stahl, Holz, schwarz, braun  
luminaire en suspension; acier, bois, noir, marron

H 1300, Ø 615



E27



3x 40W



9 002759 434632





43756

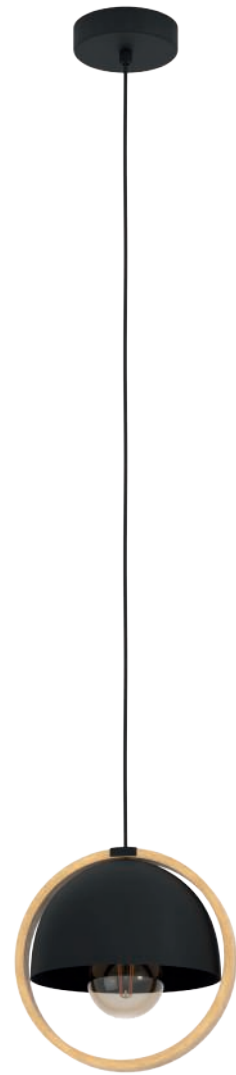

43755



### 43756 CALLOW

pendant light; steel, wood, black, brown  
 Hängeleuchte; Stahl, Holz, schwarz, braun  
 luminaire en suspension; acier, bois, noir, marron

L 930, B 230, H 1100



E27



3x 40W



9 002759 437565

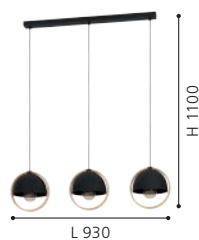

### 43755 CALLOW

pendant light; steel, wood, black, brown  
 Hängeleuchte; Stahl, Holz, schwarz, braun  
 luminaire en suspension; acier, bois, noir, marron

H 1100, Ø 230



E27



1x 40W



9 002759 437558





### 43739 SHERBURN

pendant light; steel, wood, black, brown  
 Hängeleuchte; Stahl, Holz, schwarz, braun  
 luminaire en suspension; acier, bois, noir, marron

L 770, B 200, H 1100



E27

3x 40W



9 002759 437398

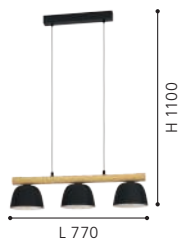

### 43738 SHERBURN

ceiling light; steel, wood, black, brown  
 Deckenleuchte; Stahl, Holz, schwarz, braun  
 plafonnier; acier, bois, noir, marron

L 800, B 200, H 255



E27

3x 40W



9 002759 437381





43901



43904



43903



### 43904 BAILRIGG

table light; steel, wood, black, brown  
Tischleuchte; Stahl, Holz, schwarz, braun  
luminaire de table; acier, bois, noir, marron

L 65, B 45, H 330, Base: B 130, T 80



E27

1x 40W



9 002759 439040



### 43903 BAILRIGG

wall light; steel, wood, black, brown  
Wandleuchte; Stahl, Holz, schwarz, braun  
Applique; acier, bois, noir, marron

L 55, H 135, A 140



E27

1x 40W



9 002759 439033



### 43901 BAILRIGG

ceiling light; steel, wood, black, brown  
Deckenleuchte; Stahl, Holz, schwarz, braun  
plafonnier; acier, bois, noir, marron

L 655, B 100, H 45



E27

3x 40W



9 002759 439019





43902



### 43902 BAILRIGG

pendant light; steel, wood, black, brown  
Hängeleuchte; Stahl, Holz, schwarz, braun  
luminaire en suspension; acier, bois, noir, marron

L 895, B 45, H 1100



E27



4x 40W



9 002759 439026

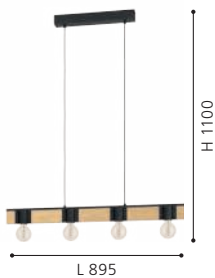

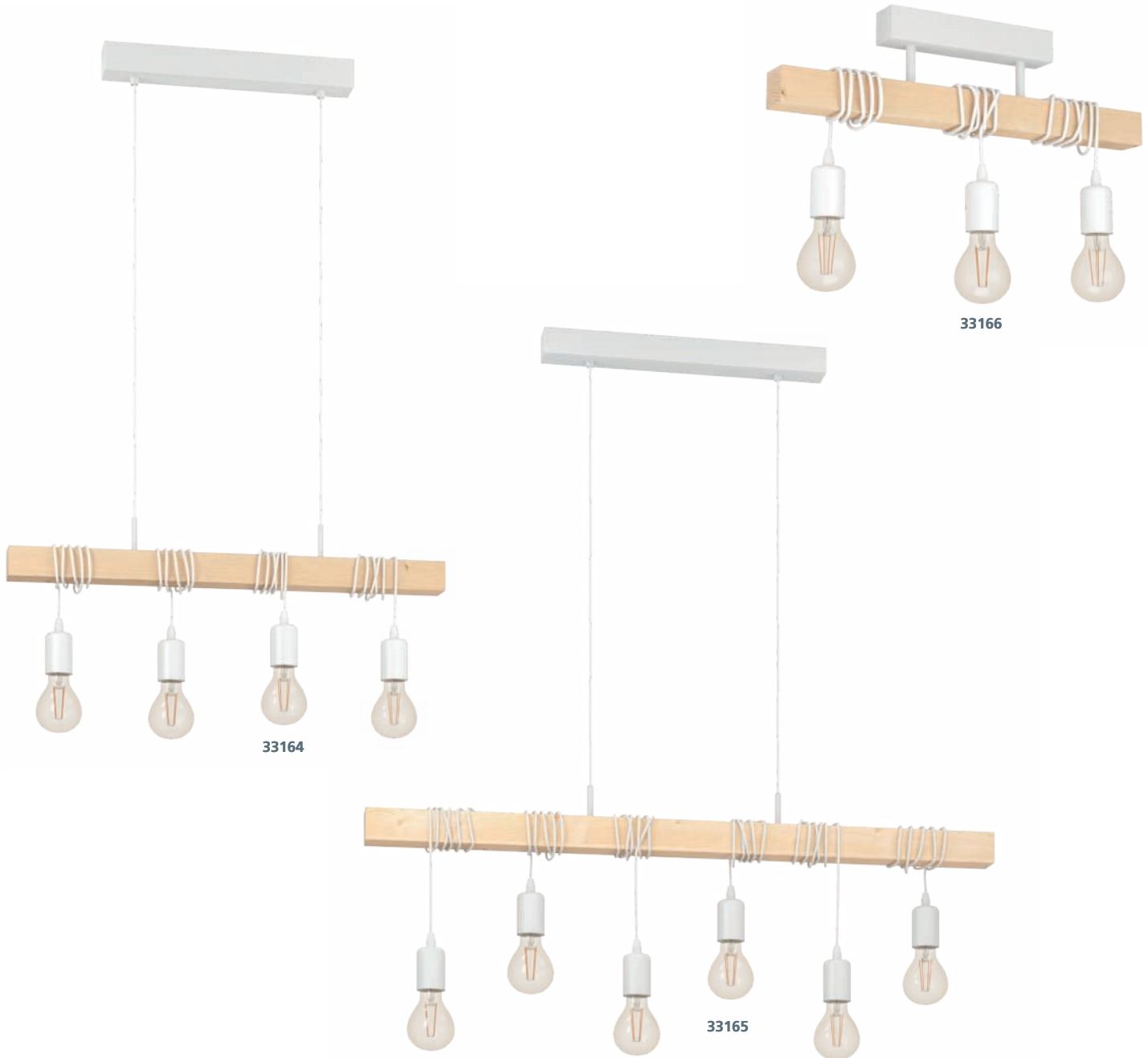

### 33164 TOWNSHEND

pendant light; steel, white / wood, brown  
 Hängeleuchte; Stahl, weiss / Holz, braun  
 luminaire en suspension; acier, blanc / bois, marron

L 700, B 105, H 1100



9 002759 331641

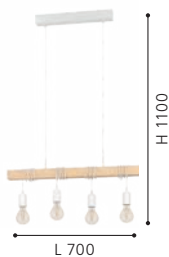

### 33165 TOWNSHEND

pendant light; steel, white / wood, brown  
 Hängeleuchte; Stahl, weiss / Holz, braun  
 luminaire en suspension; acier, blanc / bois, marron

L 1000, B 100, H 1100



9 002759 331658

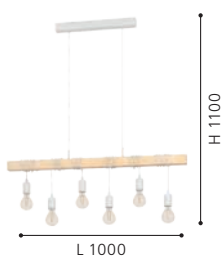

### 33166 TOWNSHEND

ceiling light; steel, white / wood, brown  
 Deckenleuchte; Stahl, weiss / Holz, braun  
 plafonnier; acier, blanc / bois, marron

L 550, B 105, H 265



9 002759 331665

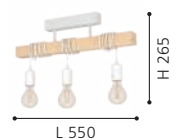



33162



33167



33163

### 33162 TOWNSHEND

wall light; steel, white / wood, brown  
Wandleuchte; Stahl, weiss / Holz, braun  
Applique; acier, blanc / bois, marron

L 65, H 215, A 185



E27



1x 10W



9 002759 331627



### 33167 TOWNSHEND

floor light; steel, white / wood, brown  
Stehleuchte; Stahl, weiss / Holz, braun  
lampadaire; acier, blanc / bois, marron

L 205, B 250, H 1665, Base: Ø 250



E27



2x 10W



9 002759 331672



### 33163 TOWNSHEND

table light; steel, white / wood, brown  
Tischleuchte; Stahl, weiss / Holz, braun  
luminaire de table; acier, blanc / bois, marron

L 175, B 155, H 500, Base: Ø 155



E27



1x 10W



9 002759 331634

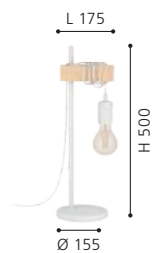



32916



32915



95499



#### DETAIL TOWNSHEND

Thanks to the long cable of the luminaire heads, the height can be adjusted individually.

Durch das lange Kabel der Leuchtenköpfe kann die Höhe individuell eingestellt werden.

Grâce au long câble des têtes de luminaire, la hauteur peut être réglée individuellement.

#### 32916 TOWNSHEND

pendant light; steel, wood, black, brown  
Hängeleuchte; Stahl, Holz, schwarz, braun  
luminaire en suspension; acier, bois, noir, marron

L 700, B 105, H 1100



E27



4x 60W



9 002759 329167

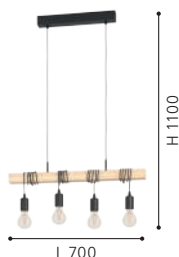

L 700

H 1100

#### 95499 TOWNSHEND

pendant light; steel, wood, black, brown / wood, brown  
Hängeleuchte; Stahl, Holz, schwarz, braun / Holz, braun  
luminaire en suspension; acier, bois, noir, marron / bois, marron

L 1000, B 100, H 1100



E27



6x 60W



9 002759 954994

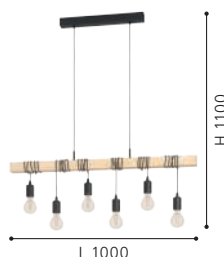

L 1000

H 1100

#### 32915 TOWNSHEND

ceiling light; steel, wood, black, brown  
Deckenleuchte; Stahl, Holz, schwarz, braun  
plafonnier; acier, bois, noir, marron

L 550, B 105, H 265



E27



3x 60W



9 002759 329150



L 550

H 265





32917



32918



32919

### 32917 TOWNSHEND

wall light; steel, wood, black, brown  
Wandleuchte; Stahl, Holz, schwarz, braun  
Applique; acier, bois, noir, marron

L 65, H 215, A 190



E27



1x 10W



9 002759 329174



L 65

H 215

A 190

### 32918 TOWNSHEND

table light; steel, wood, black, brown  
Tischleuchte; Stahl, Holz, schwarz, braun  
luminaire de table; acier, bois, noir, marron

L 175, B 155, H 500, Base: Ø 155



E27



1x 10W



9 002759 329181



L 175

H 500

Ø 155

### 32919 TOWNSHEND

floor light; steel, wood, black, brown  
Stehleuchte; Stahl, Holz, schwarz, braun  
lampadaire; acier, bois, noir, marron

L 205, B 250, H 1665, Base: Ø 250



E27



2x 10W



9 002759 329198



L 205

H 1665

Ø 250



43629



49755

### 43629 TOWNSHEND

pendant light; steel, wood, black, brown  
 Hängeleuchte; Stahl, Holz, schwarz, braun  
 luminaire en suspension; acier, bois, noir, marron

L 700, B 390, H 900



E27



5x 60W



9 002759 436292



### 49755 TOWNSHEND

pendant light; steel, black / wood, black  
 Hängeleuchte; Stahl, schwarz / Holz, schwarz  
 luminaire en suspension; acier, noir / bois, noir

L 1000, B 100, H 1100



E27



6x 60W



9 002759 497552

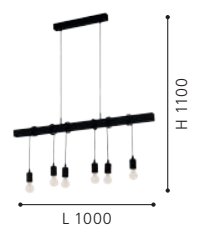



49744



43134

#### DETAIL TOWNSHEND, TOWNSHEND 5

Thanks to the long cable of the luminaire heads, the height can be adjusted individually.

Durch das lange Kabel der Leuchtenköpfe kann die Höhe individuell eingestellt werden.

Grâce au long câble des têtes de luminaire, la hauteur peut être réglée individuellement.



#### 49744 TOWNSHEND

pendant light; wood, steel, brown, black  
Hängeleuchte; Holz, Stahl, braun, schwarz  
luminaire en suspension; bois, acier, marron, noir

L 1500, B 100, H 1100



E27



9x 60W



9 002759 497446

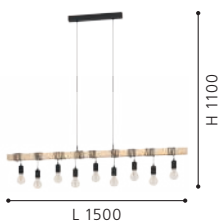

#### 43134 TOWNSHEND 5

pendant light; steel, wood, black, brown  
Hängeleuchte; Stahl, Holz, schwarz, braun  
luminaire en suspension; acier, bois, noir, marron

L 1500, B 200, H 1100



E27



9x 60W



9 002759 431341

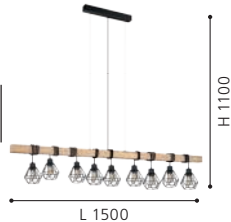



43131



43132

### 43131 TOWNSHEND 5

ceiling light; steel, wood, black, brown  
Deckenleuchte; Stahl, Holz, schwarz, braun  
plafonnier; acier, bois, noir, marron

L 550, B 200, H 360



E27 3x 60W



9 002759 431310



L 550

H 360

### 43132 TOWNSHEND 5

pendant light; steel, wood, black, brown  
Hängeleuchte; Stahl, Holz, schwarz, braun  
luminaire en suspension; acier, bois, noir, marron

L 700, B 200, H 1100



E27 4x 60W



9 002759 431327



L 700

H 1100

### 43135 TOWNSHEND 5

wall light; steel, wood, black, brown  
Wandleuchte; Stahl, Holz, schwarz, braun  
Applique; acier, bois, noir, marron

L 140, H 275, A 240



E27 1x 60W



9 002759 431358



L 140

H 275

A 240



43135



43137



43136

### 43137 TOWNSHEND 5

floor light; steel, wood, black, brown  
 Stehleuchte; Stahl, Holz, schwarz, braun  
 lampadaire; acier, bois, noir, marron

L 400, B 250, H 1665, Base: Ø 250



E27 2x 60W

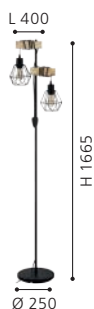

9 002759 431372

### 43136 TOWNSHEND 5

table light; steel, wood, black, brown  
 Tischleuchte; Stahl, Holz, schwarz, braun  
 luminaire de table; acier, bois, noir, marron

L 220, B 155, H 500, Base: Ø 155



E27 1x 60W



9 002759 431365

### 43133 TOWNSHEND 5

pendant light; steel, wood, black, brown  
 Hängeleuchte; Stahl, Holz, schwarz, braun  
 luminaire en suspension; acier, bois, noir, marron

L 1000, B 200, H 1100



E27 6x 60W



9 002759 431334



43133

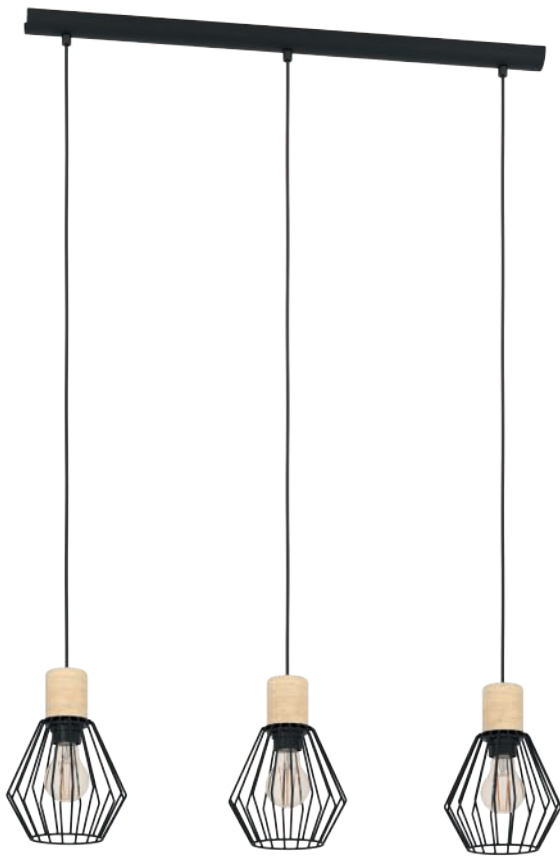

43378



43581

### 43378 PALMORLA

pendant light; steel, wood, black, brown  
 Hängeleuchte; Stahl, Holz, schwarz, braun  
 luminaire en suspension; acier, bois, noir, marron

L 760, B 160, H 1100



E27 3x 60W



9 002759 433789



### 43581 DISTAFF

pendant light; steel, black  
 Hängeleuchte; Stahl, schwarz  
 luminaire en suspension; acier, noir

L 900, B 185, H 1100



E27 3x 40W



9 002759 435813



### 43582 DISTAFF

pendant light; steel, black  
 Hängeleuchte; Stahl, schwarz  
 luminaire en suspension; acier, noir

H 1300, Ø 340



E27 3x 40W



9 002759 435820







43582

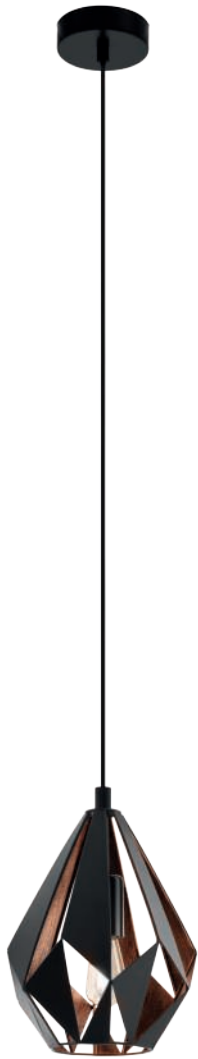

49997



49878

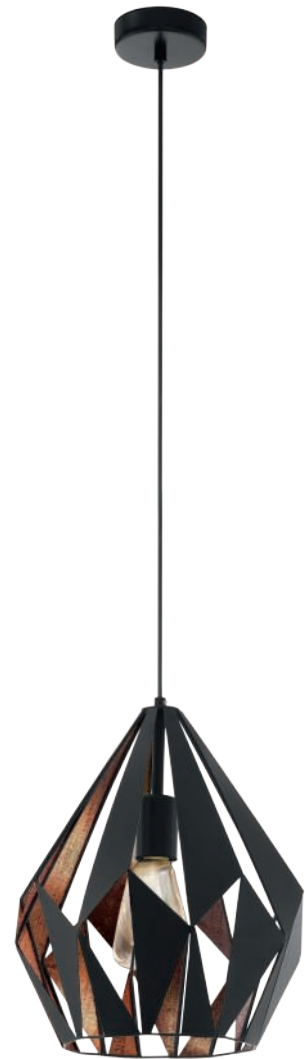

49254

### 49997 CARLTON 1

pendant light; steel, black, copper  
Hängeleuchte; Stahl, schwarz, kupfer  
luminaire en suspension; acier, noir, cuivre

H 1100, Ø 205



E27 1x 60W



9 002759 499976

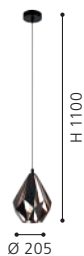

### 49878 CARLTON 1

pendant light; steel, black, copper  
Hängeleuchte; Stahl, schwarz, kupfer  
luminaire en suspension; acier, noir, cuivre

H 1500, Ø 385



E27 1x 60W



9 002759 498788



### 49254 CARLTON 1

pendant light; steel, black, copper  
Hängeleuchte; Stahl, schwarz, kupfer  
luminaire en suspension; acier, noir, cuivre

H 1100, Ø 310



E27 1x 60W



9 002759 492540





49991



49994

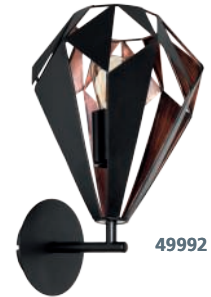

49992

#### DETAIL 49992

This wall luminaires can be mounted with the head up and down.  
 Diese Wandleuchten können mit dem Kopf nach oben und unten montiert werden.  
 Cette appliques peuvent être montée avec la tête en haut ou en bas.



#### 49991 CARLTON 1

pendant light; steel, black, copper  
 Hängeleuchte; Stahl, schwarz, kupfer  
 luminaire en suspension; acier, noir, cuivre

L 805, B 205, H 1100



E27 3x 60W



9 002759 499914



#### 49994 CARLTON 1

floor light; steel, black, copper  
 Stehleuchte; Stahl, schwarz, kupfer  
 lampadaire; acier, noir, cuivre

H 1525, Ø 255, Base: Ø 230

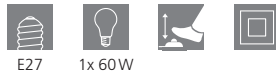

E27 1x 60W



9 002759 499945



#### 49992 CARLTON 1

wall light; steel, black, copper  
 Wandleuchte; Stahl, schwarz, kupfer  
 Applique; acier, noir, cuivre

L 205, H 330, A 220



E27 1x 60W



9 002759 499921

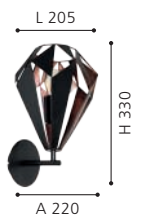



43846



43716

### 43846 CARLTON 1

pendant light; steel, black, copper  
Hängeleuchte; Stahl, schwarz, kupfer  
luminaire en suspension; acier, noir, cuivre

L 1455, B 385, H 1070



E27



6x 40W



9 002759 438463



L 1455

H 1070

### 43716 CARLTON 7

spot; steel, black, antique copper coloured  
Spot; Stahl, schwarz, kupferfarben-antik  
spot; acier, noir, aspect cuivre-antique

L 420, B 160, H 255



E27



2x 40W



9 002759 437169



L 420

H 255



43717



43718



43715

### 43717 CARLTON 7

spot; steel, black, antique copper coloured  
Spot; Stahl, schwarz, kupferfarben-antik  
spot; acier, noir, aspect cuivre-antique

L 730, B 160, H 255



E27



3x 40W



9 002759 437176



### 43715 CARLTON 7

spot; steel, black, antique copper coloured  
Spot; Stahl, schwarz, kupferfarben-antik  
spot; acier, noir, aspect cuivre-antique

Ø 160, A 255



E27



1x 40W



9 002759 437152

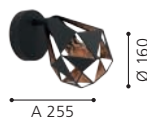

### 43718 CARLTON 7

spot; steel, black, antique copper coloured  
Spot; Stahl, schwarz, kupferfarben-antik  
spot; acier, noir, aspect cuivre-antique

L 370, B 370, H 255



E27



4x 40W



9 002759 437183





43057



43399



43058

#### 43057 CARLTON 4

wall light; steel, black, antique copper coloured  
Wandleuchte; Stahl, schwarz, kupferfarben-antik  
Applique; acier, noir, aspect cuivre-antique

L 160, H 315, A 225



E27 1x 60W



9 002759 430573



#### 43058 CARLTON 4

table light; steel, black, antique copper coloured  
Tischleuchte; Stahl, schwarz, kupferfarben-antik  
luminaire de table; acier, noir, aspect cuivre-antique

L 220, B 160, H 505, Base: Ø 170

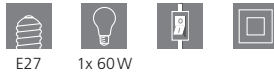

E27 1x 60W



9 002759 430580

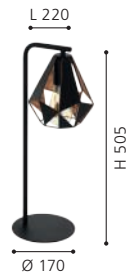

#### 43399 CARLTON 6

ceiling light; steel, black, copper  
Deckenleuchte; Stahl, schwarz, kupfer  
plafonnier; acier, noir, cuivre

H 235, Ø 470



E27 1x 60W



9 002759 433994





43077

### 43077 CARLTON 5

table light; steel, black, copper / fabric, black, copper  
Tischleuchte; Stahl, schwarz, kupfer / Textil, schwarz, kupfer  
luminaire de table; acier, noir, cuivre / tissu, noir, cuivre

H 510, Ø 250



E27



1x 60W



9 002759 430771



49932



43002



43078

### 49932 CARLTON 1

pendant light; steel, white, honey gold  
Hängeleuchte; Stahl, weiss, honiggold  
luminaire en suspension; acier, blanc, or

H 1100, Ø 310



E27 1x 60W



9 002759 499327



### 43002 CARLTON 1

pendant light; steel, white, gold  
Hängeleuchte; Stahl, weiss, gold  
luminaire en suspension; acier, blanc, or

L 805, B 205, H 1100



E27 3x 60W



9 002759 430023

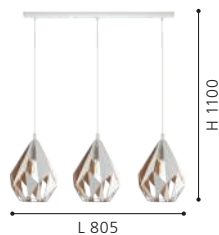

### 43078 CARLTON 5

table light; steel, white, honey gold / fabric, white  
Tischleuchte; Stahl, weiss, honiggold / Textil, weiss  
luminaire de table; acier, blanc, or / tissu, blanc

H 510, Ø 250, Base: Ø 120

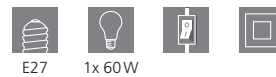

E27 1x 60W



9 002759 430788







43001

### 43001 CARLTON 1

pendant light; steel, white, gold  
Hängeleuchte; Stahl, weiss, gold  
luminaire en suspension; acier, blanc, or

H 1100, Ø 205



E27



1x 60W



9 002759 430016





49255



49931



49026

### 49255 CARLTON 1

pendant light; steel, black, silver  
 Hängeleuchte; Stahl, schwarz, silber  
 luminaire en suspension; acier, noir, argent

H 1100, Ø 310



E27 1x 60W



9 002759 492557



### 49931 CARLTON 1

pendant light; steel, black, gold  
 Hängeleuchte; Stahl, schwarz, gold  
 luminaire en suspension; acier, noir, or

H 1100, Ø 310



E27 1x 60W



9 002759 499310



### 49026 CARLTON-P

pendant light; steel, pastel light green  
 Hängeleuchte; Stahl, Pastell hellgrün  
 luminaire en suspension; acier, pastel vert clair

H 1500, Ø 310



E27 1x 60W



9 002759 490263





49024

### 49024 CARLTON-P

pendant light; steel, pastel apricot  
Hängeleuchte; Stahl, Pastell apricot  
luminaire en suspension; acier, Pastel abricot

H 1500, Ø 310



E27



1x 60W



9 002759 490249





43909



43908

### 43909 CARLTON

pendant light; steel, gold-coloured  
Hängeleuchte; Stahl, goldfarben  
luminaire en suspension; acier, or

L 805, B 205, H 1100



E27



3x 60W



9 002759 439095



### 43908 CARLTON

ceiling light; steel, gold-coloured  
Deckenleuchte; Stahl, goldfarben  
plafonnier; acier, or

H 235, Ø 470



E27



1x 60W



9 002759 439088





43815

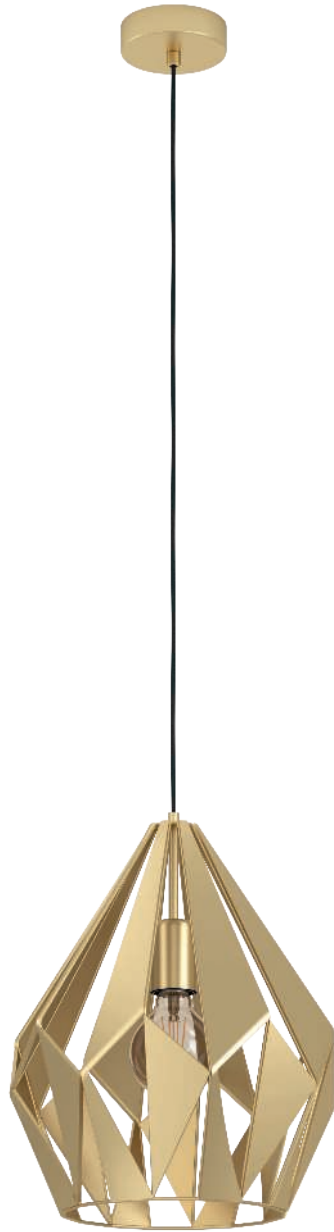

43814

### 43815 CARLTON

pendant light; steel, gold-coloured  
Hängeleuchte; Stahl, goldfarben  
luminaire en suspension; acier, or

H 1100, Ø 385



E27



1x 60W



9 002759 438159

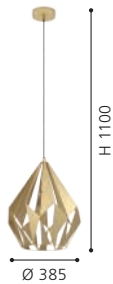

### 43814 CARLTON

pendant light; steel, gold-coloured  
Hängeleuchte; Stahl, goldfarben  
luminaire en suspension; acier, or

H 1100, Ø 310



E27



1x 60W



9 002759 438142





49258



49259



49933

### 49258 CARLTON

pendant light; steel, copper-coloured  
Hängeleuchte; Stahl, kupferfarben  
luminaire en suspension; acier, cuivré

H 1100, Ø 310



E27 1x 60W



9 002759 492588

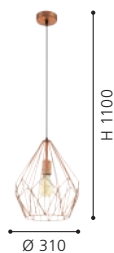

### 49259 CARLTON

pendant light; steel, mint  
Hängeleuchte; Stahl, mint  
luminaire en suspension; acier, menthe

H 1100, Ø 310



E27 1x 60W



9 002759 492595



### 49933 CARLTON

pendant light; steel, gold-coloured  
Hängeleuchte; Stahl, goldfarben  
luminaire en suspension; acier, or

H 1100, Ø 310



E27 1x 60W



9 002759 499334





49935



49257

### 49935 CARLTON

pendant light; steel, silver  
Hängeleuchte; Stahl, silber  
luminaire en suspension; acier, argent

H 1100, Ø 310



E27



1x 60W



9 002759 499358



### 49257 CARLTON

pendant light; steel, black  
Hängeleuchte; Stahl, schwarz  
luminaire en suspension; acier, noir

H 1100, Ø 310



E27



1x 60W



9 002759 492571





43695

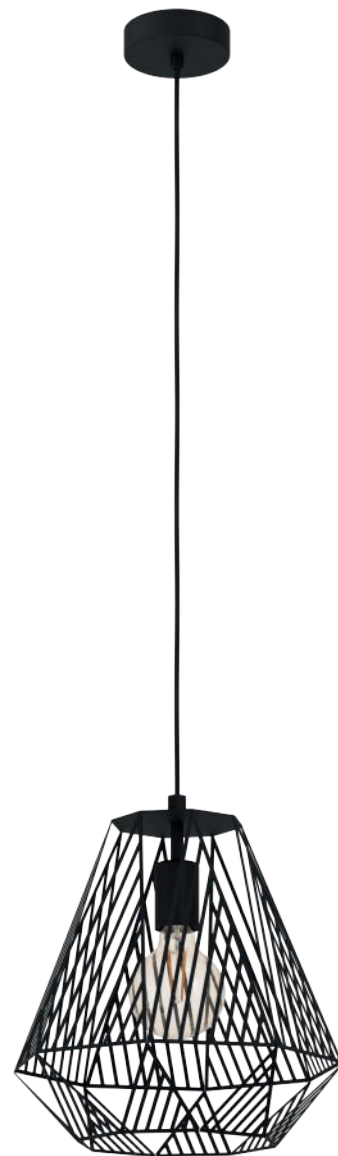

43692

### 43695 STYPE

pendant light; steel, gold-coloured  
Hängeleuchte; Stahl, goldfarben  
luminaire en suspension; acier, or

H 1100, Ø 330



E27



1x 40W



9 002759 436957



### 43692 STYPE

pendant light; steel, black  
Hängeleuchte; Stahl, schwarz  
luminaire en suspension; acier, noir

H 1100, Ø 330



E27



1x 40W



9 002759 436926







43696



43693

### 43696 STYPE

pendant light; steel, gold-coloured  
Hängeleuchte; Stahl, goldfarben  
luminaire en suspension; acier, or

L 960, B 200, H 1100



E27



3x 40W



9 002759 436964



### 43693 STYPE

pendant light; steel, black  
Hängeleuchte; Stahl, schwarz  
luminaire en suspension; acier, noir

L 960, B 200, H 1100



E27



3x 40W



9 002759 436933





43359



43361

### 43359 STRAITON

pendant light; steel, black  
Hängeleuchte; Stahl, schwarz  
luminaire en suspension; acier, noir

H 1100, Ø 515



E27 1x 60W



9 002759 433598

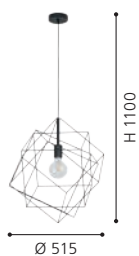

### 43361 STRAITON

pendant light; steel, black  
Hängeleuchte; Stahl, schwarz  
luminaire en suspension; acier, noir

L 905, B 240, H 1100



E27 3x 60W



9 002759 433611



### 43358 STRAITON

pendant light; steel, black  
Hängeleuchte; Stahl, schwarz  
luminaire en suspension; acier, noir

L 240, B 205, H 1100



E27 1x 60W



9 002759 433581

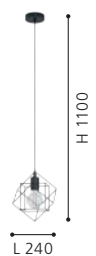



43358





43481



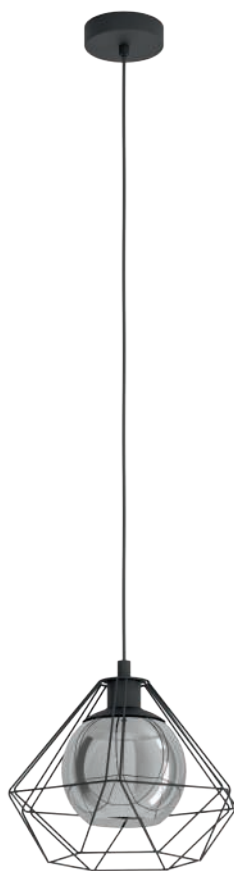

43482



43483

### 43481 VERNHAM

pendant light; steel, black / glass vaporized, black-transparent  
 Hängeleuchte; Stahl, schwarz / Glas bedampft, schwarz-transparent  
 luminaire en suspension; acier, noir / verre vaporisé, noir transparent

H 1100, Ø 445



E27



1x 40W



9 002759 434816

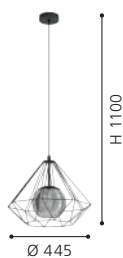

### 43482 VERNHAM

pendant light; steel, black / glass vaporized, black-transparent  
 Hängeleuchte; Stahl, schwarz / Glas bedampft, schwarz-transparent  
 luminaire en suspension; acier, noir / verre vaporisé, noir transparent

H 1100, Ø 325



E27



1x 40W



9 002759 434823

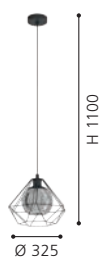

### 43483 VERNHAM

pendant light; steel, black / glass vaporized, black-transparent  
 Hängeleuchte; Stahl, schwarz / Glas bedampft, schwarz-transparent  
 luminaire en suspension; acier, noir / verre vaporisé, noir transparent

L 1145, B 325, H 1100



E27



3x 40W



9 002759 434830





43004



49081

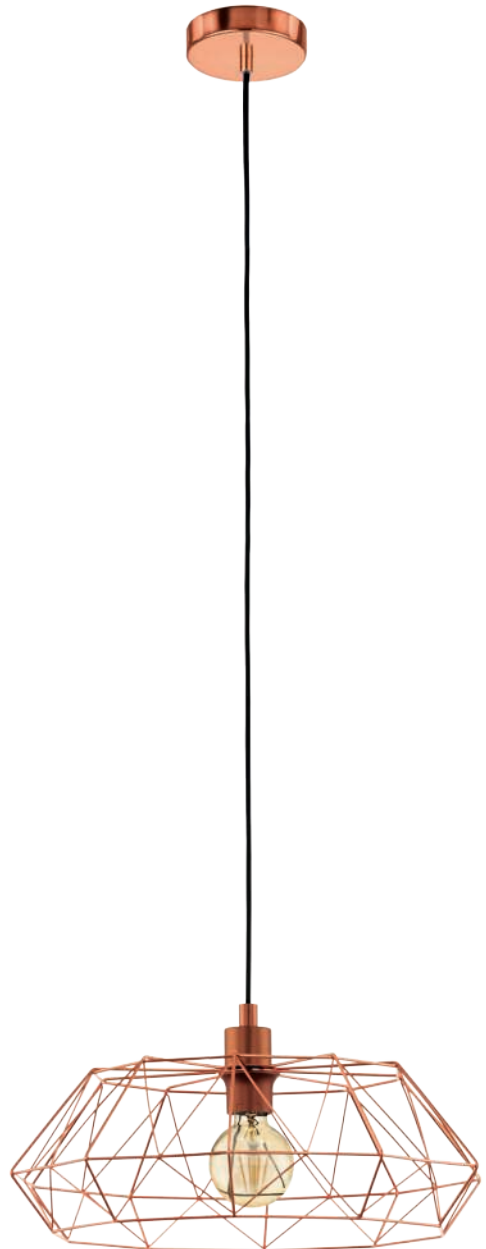

49488

### 43004 TARBES

ceiling light; steel, black  
Deckenleuchte; Stahl, schwarz  
plafonnier; acier, noir

H 275, Ø 325



E27 1x 60W



9 002759 430047

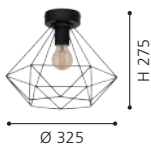

### 49081 TARBES

wall light; steel, black  
Wandleuchte; Stahl, schwarz  
Applique; acier, noir

L 155, H 375, A 275



E27 1x 60W



9 002759 490812



### 49488 CARLTON 2

pendant light; steel, copper  
Hängeleuchte; Stahl, kupfer  
luminaire en suspension; acier, cuivre

H 1100, Ø 455



E27 1x 60W



9 002759 494889





49487

### 49487 CARLTON 2

pendant light; steel, black  
Hängeleuchte; Stahl, schwarz  
luminaire en suspension; acier, noir

H 1100, Ø 455



E27



1x 60W



9 002759 494872

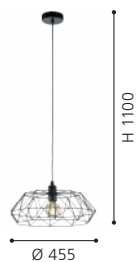



43766



43767

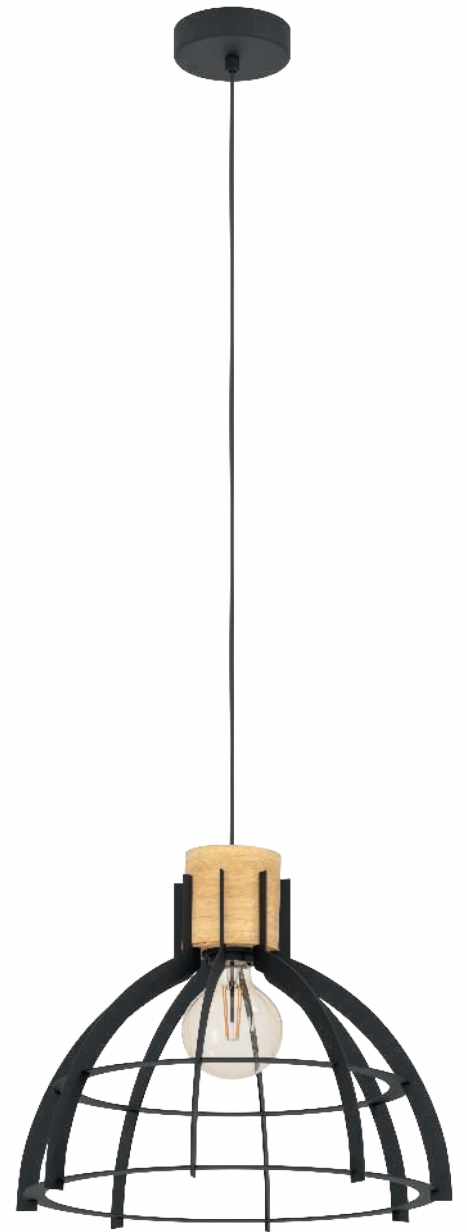

43769

### 43766 STILLINGTON

ceiling light; steel, black, gold  
Deckenleuchte; Stahl, schwarz, gold  
plafonnier; acier, noir, or

H 315, Ø 415



E27 1x 40W



9 002759 437664



### 43767 STILLINGTON

pendant light; steel, black, gold  
Hängeleuchte; Stahl, schwarz, gold  
luminaire en suspension; acier, noir, or

H 1100, Ø 415



E27 1x 40W



9 002759 437671



### 43769 STILLINGTON

pendant light; steel, wood, black, brown  
Hängeleuchte; Stahl, Holz, schwarz, braun  
luminaire en suspension; acier, bois, noir, marron

H 1100, Ø 415



E27 1x 40W



9 002759 437695

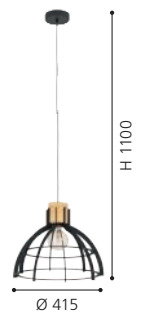





43768

### 43768 STILLINGTON

ceiling light; steel, wood, black, brown  
Deckenleuchte; Stahl, Holz, schwarz, braun  
plafonnier; acier, bois, noir, marron

H 315, Ø 415



E27



1x 40W



9 002759 437688

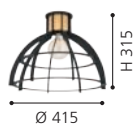



43928



43926



43927



### 43926 STILLINGTON 1

spot; steel, wood, black, brown  
Spot; Stahl, Holz, schwarz, braun  
spot; acier, bois, noir, marron

H 245, Ø 160

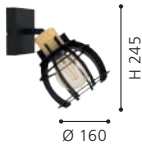

### 43928 STILLINGTON 1

spot; steel, wood, black, brown  
Spot; Stahl, Holz, schwarz, braun  
spot; acier, bois, noir, marron

L 710, B 160, H 245



### 43927 STILLINGTON 1

spot; steel, wood, black, brown  
Spot; Stahl, Holz, schwarz, braun  
spot; acier, bois, noir, marron

L 420, B 160, H 245





43925



### 43925 STILLINGTON 1

pendant light; steel, wood, black, brown  
Hängeleuchte; Stahl, Holz, schwarz, braun  
luminaire en suspension; acier, bois, noir, marron

L 880, B 180, H 1100



E27



3x 40W



9 002759 439255



DESIGN  
HIGHLIGHT  
DETAIL



43819



43818



43817

### 43819 SOUTHERY

spot; steel, brushed creme-gold, white  
Spot; Stahl, creme-gold gebürstet, weiss  
spot; acier, or crème brossé, blanc

L 700, B 110, H 210



E27 3x 40W



9 002759 438197

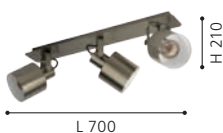

### 43818 SOUTHERY

spot; steel, brushed creme-gold, white  
Spot; Stahl, creme-gold gebürstet, weiss  
spot; acier, or crème brossé, blanc

L 470, B 110, H 210



E27 2x 40W



9 002759 438180



### 43817 SOUTHERY

spot; steel, brushed creme-gold, white  
Spot; Stahl, creme-gold gebürstet, weiss  
spot; acier, or crème brossé, blanc

L 185, B 110, H 210



E27 1x 40W



9 002759 438173





43816

### 43816 SOUTHERY

pendant light; steel, brushed creme-gold, white  
Hängeleuchte; Stahl, creme-gold gebürstet, weiss  
luminaire en suspension; acier, or crème brossé, blanc

H 1100, Ø 350



E27



1x 40W



9 002759 438166

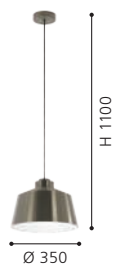



43443



#### DETAIL 43599

This ceiling luminaires have a great play of light.

Diese Deckenleuchten verfügen über ein tolles Lichtspiel.

Ces plafonniers disposent d'un superbe jeu de lumière.

#### 43443 CASTANUELO

wall/ceiling light; steel, gold

Wand- / Deckenleuchte; Stahl, gold

Applique/Plafonnier; acier, or

H 105, Ø 425



E27



1x 40W



9 002759 434434

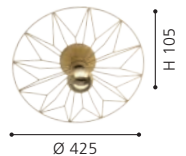



43599



43808



43809

### 43599 CASTANUELO

wall/ceiling light; steel, gold  
Wand- / Deckenleuchte; Stahl, gold  
Applique/Plafonnier; acier, or

H 100, Ø 425



E27



1x 40W



9 002759 435998

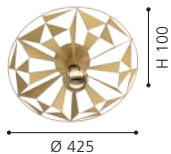

### 43808 CASTANUELO

table light; steel, black, gold  
Tischleuchte; Stahl, schwarz, gold  
luminaire de table; acier, noir, or

L 370, B 270, H 575, Base: Ø 295



E27



1x 40W



9 002759 438081



### 43809 CASTANUELO

floor light; steel, black, gold  
Stehleuchte; Stahl, schwarz, gold  
lampadaire; acier, noir, or

L 500, B 270, H 1520, Base: Ø 745



E27



1x 40W



9 002759 438098

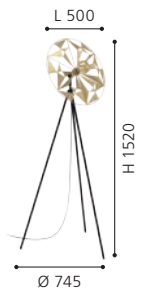



43679

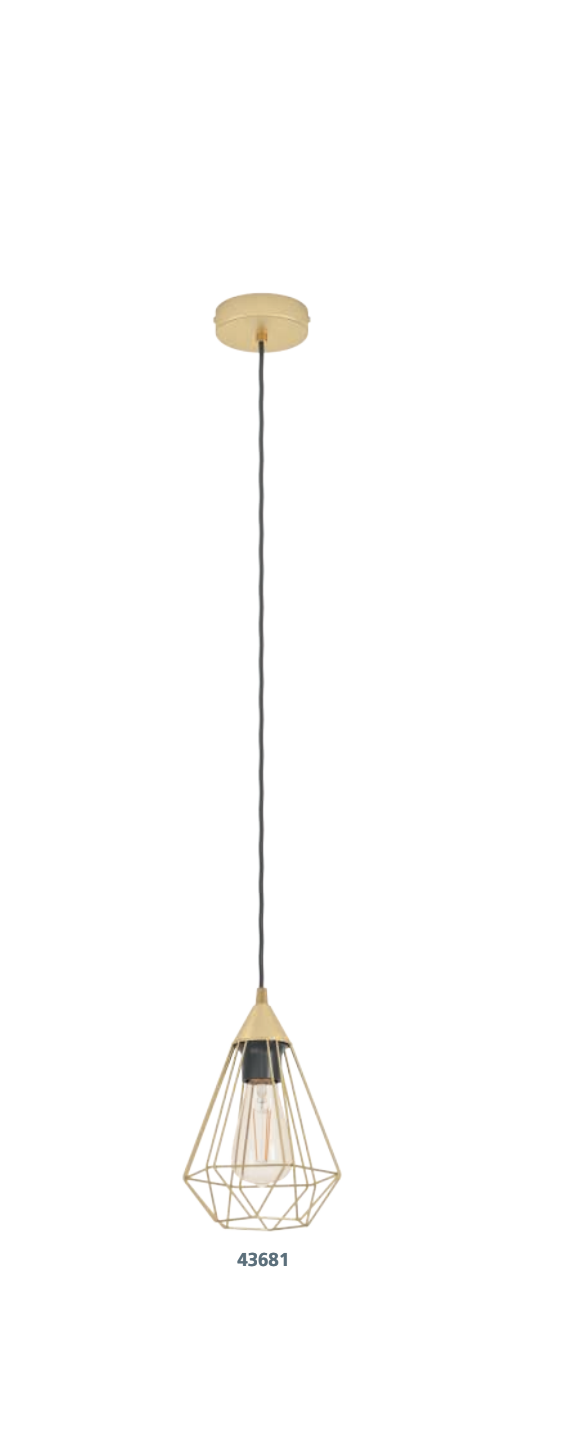

43681

### 43679 TARDES

pendant light; steel, brushed brass  
 Hängeleuchte; Stahl, messing-gebürstet  
 luminaire en suspension; acier, laiton brossé

H 1100, Ø 325



E27 1x 60W



9 002759 436797



### 43681 TARDES

pendant light; steel, brushed brass  
 Hängeleuchte; Stahl, messing-gebürstet  
 luminaire en suspension; acier, laiton brossé

H 1300, Ø 175



E27 1x 60W



9 002759 436810

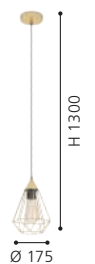





43682



43683

### 43682 TARBES

pendant light; steel, brushed brass  
 Hängeleuchte; Stahl, messing-gebürstet  
 luminaire en suspension; acier, laiton brossé

L 795, B 175, H 1300



E27



3x 60W



9 002759 436827



### 43683 TARBES

pendant light; steel, brushed brass  
 Hängeleuchte; Stahl, messing-gebürstet  
 luminaire en suspension; acier, laiton brossé

H 1300, Ø 355



E27



3x 60W



9 002759 436834





43654



43655

### 43654 TARBES 2

ceiling light; steel, black, brass  
Deckenleuchte; Stahl, schwarz, messing  
plafonnier; acier, noir, laiton

H 245, Ø 450



E27



3x 40W



9 002759 436544



Ø 450

H 245

### 43655 TARBES 2

ceiling light; steel, black, brass  
Deckenleuchte; Stahl, schwarz, messing  
plafonnier; acier, noir, laiton

L 770, B 175, H 245



E27



3x 40W



9 002759 436551



L 770

H 245



43678



43684



43685

### 43678 TARDES

ceiling light; steel, brushed brass  
Deckenleuchte; Stahl, messing-gebürstet  
plafonnier; acier, laiton brossé

H 275, Ø 325



E27



1x 60W



9 002759 436780



### 43684 TARDES

wall light; steel, brushed brass  
Wandleuchte; Stahl, messing-gebürstet  
Applique; acier, laiton brossé

L 155, H 345, A 275



E27



1x 60W



9 002759 436841



### 43685 TARDES

table light; steel, brushed brass  
Tischleuchte; Stahl, messing-gebürstet  
luminaire de table; acier, laiton brossé

H 265, Ø 175



E27



1x 60W



9 002759 436858

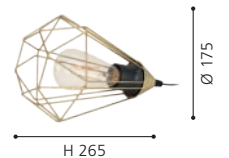



94191



94187

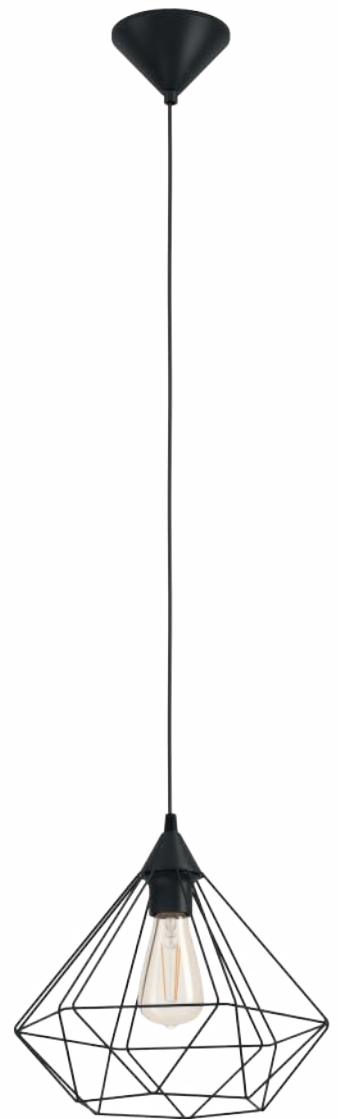

94188

### 94191 TARBES

pendant light; steel, black / steel, black  
 Hängeleuchte; Stahl, schwarz / Stahl, schwarz  
 luminaire en suspension; acier, noir / acier, noir

H 1100, Ø 310



E27 3x 60W



9 002759 941918



### 94187 TARBES

pendant light; plastic, black / steel, black  
 Hängeleuchte; Kunststoff, schwarz / Stahl, schwarz  
 luminaire en suspension; plastique, noir / acier, noir

H 1100, Ø 175



E27 1x 60W



9 002759 941871

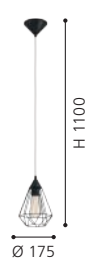

### 94188 TARBES

pendant light; plastic, black / steel, black  
 Hängeleuchte; Kunststoff, schwarz / Stahl, schwarz  
 luminaire en suspension; plastique, noir / acier, noir

H 1100, Ø 325



E27 1x 60W



9 002759 941888





94189



94192

### 94189 TARBES

pendant light; steel, black / steel, black  
 Hängeleuchte; Stahl, schwarz / Stahl, schwarz  
 luminaire en suspension; acier, noir / acier, noir

L 790, B 175, H 1100



E27



3x 60W



9 002759 941895

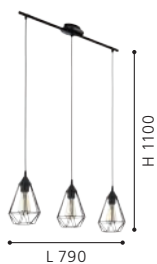

### 94192 TARBES

table light; steel, black / steel, black  
 Tischleuchte; Stahl, schwarz / Stahl, schwarz  
 luminaire de table; acier, noir / acier, noir

H 265, Ø 175



E27



1x 60W



9 002759 941925

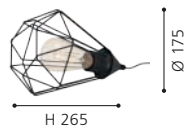



94194

94195

**94194 TARBES**

pendant light; plastic, black / steel, copper-coloured  
 Hängeleuchte; Kunststoff, schwarz / Stahl, kupferfarben  
 luminaire en suspension; plastique, noir / acier, cuivré

H 1100, Ø 325



E27 1x 60W



9 002759 941949

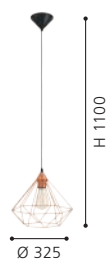

**94195 TARBES**

pendant light; steel, black / steel, copper-coloured  
 Hängeleuchte; Stahl, schwarz / Stahl, kupferfarben  
 luminaire en suspension; acier, noir / acier, cuivré

L 790, B 175, H 1100



E27 3x 60W



9 002759 941956

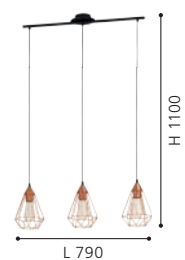



94196



94193

### 94196 TARDES

pendant light; steel, black / steel, copper-coloured  
Hängeleuchte; Stahl, schwarz / Stahl, kupferfarben  
luminaire en suspension; acier, noir / acier, cuivré

H 1100, Ø 310



E27



3x 60W



9 002759 941963

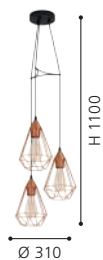

### 94193 TARDES

pendant light; plastic, black / steel, copper-coloured  
Hängeleuchte; Kunststoff, schwarz / Stahl, kupferfarben  
luminaire en suspension; plastique, noir / acier, cuivré

H 1100, Ø 175



E27



1x 60W



9 002759 941932





49643



49644

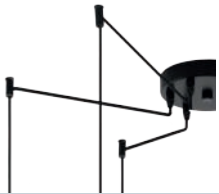

**DETAIL 49643**

The luminaire heads can be installed on the ceiling individually.  
 Die Leuchtenköpfe können individuell an die Decke montiert werden.  
 Les têtes de luminaires peuvent être montées individuellement au plafond.

**49643 ROCCAMENA**

pendant light; steel, black, copper  
 Hängeleuchte; Stahl, schwarz, kupfer  
 luminaire en suspension; acier, noir, cuivre

B 130, H 1300



E27



6x 60W



9 002759 496432



**49644 ROCCAMENA**

pendant light; steel, black, copper  
 Hängeleuchte; Stahl, schwarz, kupfer  
 luminaire en suspension; acier, noir, cuivre

H 1100, Ø 130



E27



1x 60W



9 002759 496449

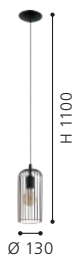





49645



49646

### 49646 ROCCAMENA

table light; steel, black, copper  
Tischleuchte; Stahl, schwarz, kupfer  
luminaire de table; acier, noir, cuivre

H 310, Ø 130, Base: Ø 130



E27



1x 60W



9 002759 496463



### 49645 ROCCAMENA

pendant light; steel, black, copper  
Hängeleuchte; Stahl, schwarz, kupfer  
luminaire en suspension; acier, noir, cuivre

L 730, B 130, H 1100



E27



3x 60W



9 002759 496456



DESIGN  
HIGHLIGHT  
DETAIL



49143

**49143 CLEVEDON**

wall light; steel, black  
Wandleuchte; Stahl, schwarz  
Applique; acier, noir

L 170, H 350, A 200



9 002759 491437



**49142 CLEVEDON**

pendant light; steel, black  
Hängeleuchte; Stahl, schwarz  
luminaire en suspension; acier, noir

L 780, B 170, H 1100



9 002759 491420





49142



49472



49477

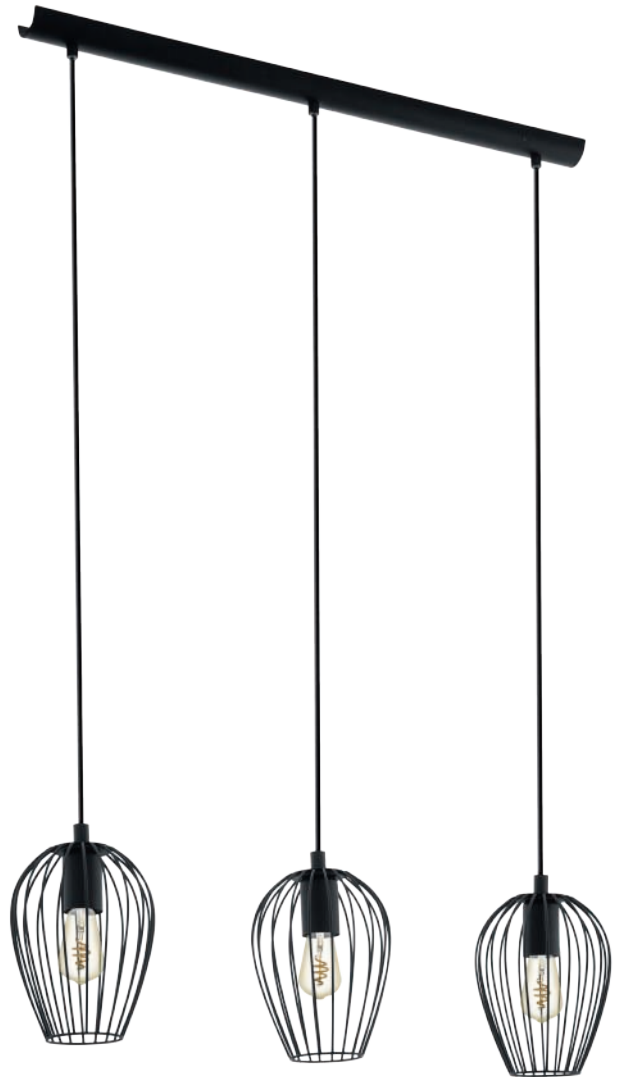

49478

### 49472 NEWTOWN

pendant light; steel, black  
Hängeleuchte; Stahl, schwarz  
luminaire en suspension; acier, noir

H 1100, Ø 275



E27 1x 60W



9 002759 494728



### 49477 NEWTOWN

pendant light; steel, black  
Hängeleuchte; Stahl, schwarz  
luminaire en suspension; acier, noir

H 1100, Ø 160



E27 1x 60W



9 002759 494773

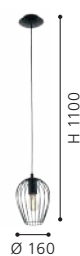

### 49478 NEWTOWN

pendant light; steel, black  
Hängeleuchte; Stahl, schwarz  
luminaire en suspension; acier, noir

L 700, B 160, H 1100



E27 3x 60W



9 002759 494780





49479



49481



49474

### 49479 NEWTOWN

pendant light; steel, black  
Hängeleuchte; Stahl, schwarz  
luminaire en suspension; acier, noir

H 1300, Ø 380



E27 3x 60W



9 002759 494797



### 49481 NEWTOWN

table light; steel, black  
Tischleuchte; Stahl, schwarz  
luminaire de table; acier, noir

H 230, Ø 160, Base: Ø 120



E27 1x 60W



9 002759 494810



### 49474 NEWTOWN

floor light; steel, black  
Stehleuchte; Stahl, schwarz  
lampadaire; acier, noir

H 1595, Ø 275, Base: Ø 230



E27 1x 60W



9 002759 494742





49447



49448

### 49447 AUSTELL

pendant light; steel, black / steel, fabric, black, gold  
 Hängeleuchte; Stahl, schwarz / Stahl, Textil, schwarz, gold  
 luminaire en suspension; acier, noir / acier, tissu, noir, or

H 1100, Ø 165



E27



1x 60W



9 002759 494476

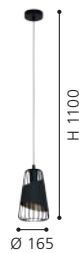

### 49448 AUSTELL

pendant light; steel, black / steel, fabric, black, gold  
 Hängeleuchte; Stahl, schwarz / Stahl, Textil, schwarz, gold  
 luminaire en suspension; acier, noir / acier, tissu, noir, or

L 765, B 165, H 1100



E27



3x 60W



9 002759 494483



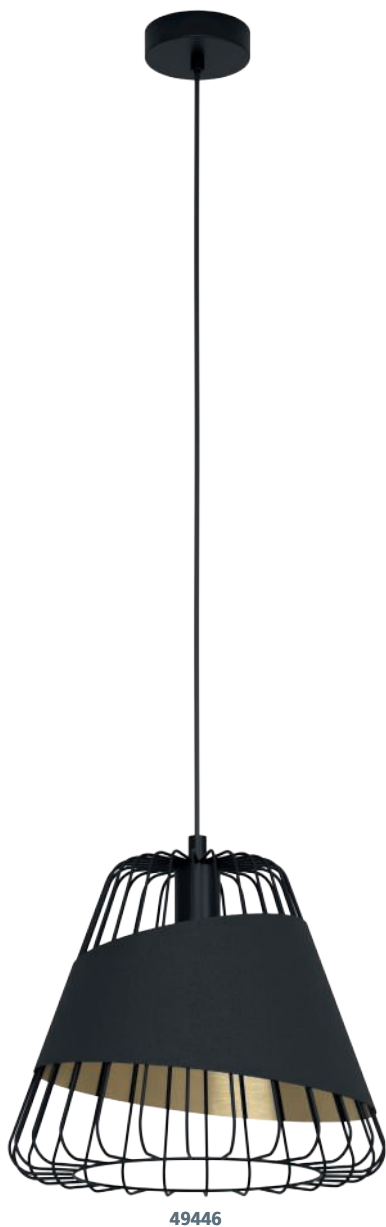

49446



49509

### 49446 AUSTELL

pendant light; steel, black / steel, fabric, black, gold  
 Hängeleuchte; Stahl, schwarz / Stahl, Textil, schwarz, gold  
 luminaire en suspension; acier, noir / acier, tissu, noir, or

H 1100, Ø 360



E27



1x 60W



9 002759 494469



### 49509 AUSTELL

pendant light; steel, black / steel, fabric, black, gold  
 Hängeleuchte; Stahl, schwarz / Stahl, Textil, schwarz, gold  
 luminaire en suspension; acier, noir / acier, tissu, noir, or

H 1100, Ø 430



E27



1x 60W



9 002759 495091





43848







43847



43849



### 43848 PLIMSOLL

pendant light; steel, wood, black  
Hängeleuchte; Stahl, Holz, schwarz  
luminaire en suspension; acier, bois, noir

L 770, B 95, H 1100



E27



4x 15W



9 002759 438487

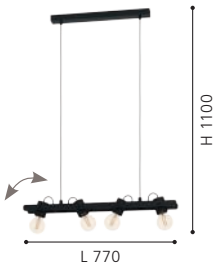

### 43847 PLIMSOLL

ceiling light; steel, wood, black  
Deckenleuchte; Stahl, Holz, schwarz  
plafonnier; acier, bois, noir

L 770, B 95, H 165



E27



4x 15W



9 002759 438470



### 43849 PLIMSOLL

table light; steel, wood, black  
Tischleuchte; Stahl, Holz, schwarz  
luminaire de table; acier, bois, noir

L 105, B 75, H 255, Base: Ø 135



E27



1x 15W



9 002759 438494

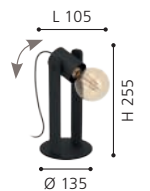

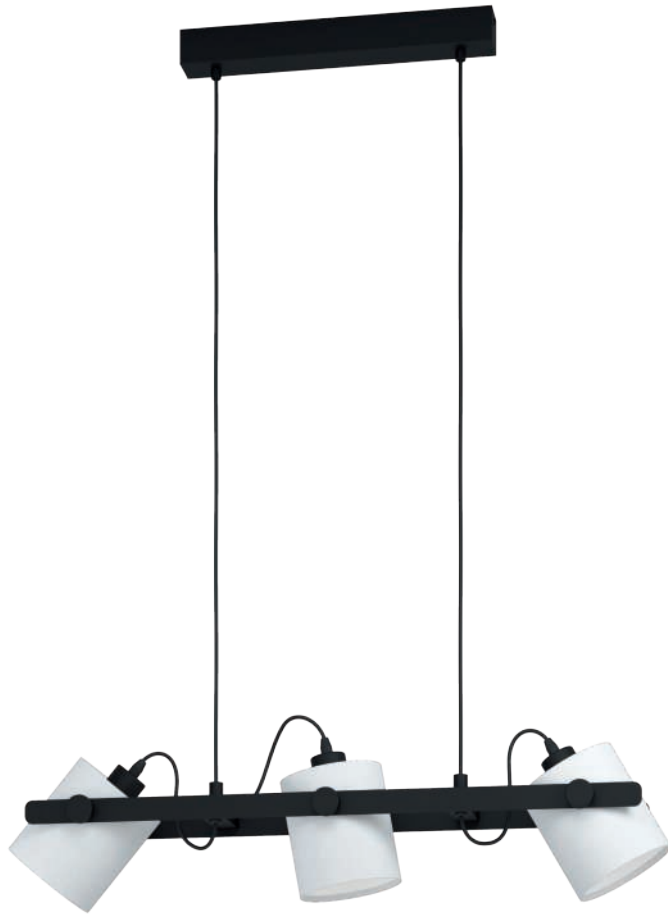

43426



43427



#### DETAIL HORNWOOD 1

The heads can be adjusted or fixed in position with the lateral screws.  
Die Köpfe können mittels den seitlichen Schrauben verstellt oder fixiert werden.  
Les têtes peuvent être réglées ou fixées à l'aide des vis latérales.



#### 43426 HORNWOOD 1

pendant light; steel, wood, black / fabric, white  
Hängeleuchte; Stahl, Holz, schwarz / Textil, weiss  
luminaire en suspension; acier, bois, noir / tissu, blanc

L 780, B 195, H 1100



E27



3x 28W



9 002759 434267

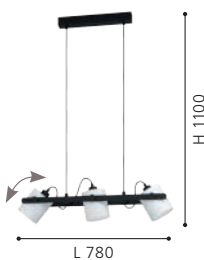

#### 43427 HORNWOOD 1

wall light; steel, wood, black / fabric, white  
Wandleuchte; Stahl, Holz, schwarz / Textil, weiss  
Applique; acier, bois, noir / tissu, blanc

L 195, A 255



E27



1x 28W



9 002759 434274

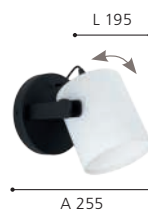

#### 43141 GLASTONBURY

floor light; steel, black / fabric, white  
Stehleuchte; Stahl, schwarz / Textil, weiss  
lampadaire; acier, noir / tissu, blanc

H 1510, Ø 240, Base: Ø 300



E27



1x 60W



9 002759 431419

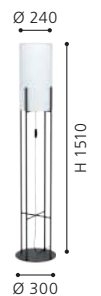



43141



94326



94324



49148

### 94326 LANTADA

floor light; wood, steel, nut / fabric, taupe  
 Stehleuchte; Holz, Stahl, nuss / Textil, taupe  
 lampadaire; bois, acier, noisette / tissu, taupe

H 1060 - 1430, Ø 450, Base: Ø 975



E27 1x 60W



9 002759 943264

### 94324 LANTADA

floor light; wood, steel, natural / fabric, beige  
 Stehleuchte; Holz, Stahl, natur / Textil, beige  
 lampadaire; bois, acier, naturel / tissu, beige

H 1060 - 1430, Ø 450, Base: Ø 975



E27 1x 60W



9 002759 943240

### 49148 BIDFORD

floor light; wood, steel, brown / fabric, cappuccino, gold  
 Stehleuchte; Holz, Stahl, braun / Textil, cappuccino, gold  
 lampadaire; bois, acier, marron / tissu, cappuccino, or

H 1540, Ø 460, Base: Ø 700

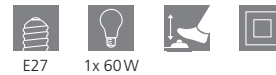

E27 1x 60W



9 002759 491482



### 49386 CHESTER

floor light; steel, black, copper  
 Stehleuchte; Stahl, schwarz, kupfer  
 lampadaire; acier, noir, cuivre

H 1495, Base: Ø 600

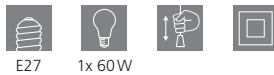

E27

1x 60W



9 002759 493868



### 49385 CHESTER

table light; steel, black, copper  
 Tischleuchte; Stahl, schwarz, kupfer  
 luminaire de table; acier, noir, cuivre

H 440, Base: Ø 290



E27

1x 60W



9 002759 493851





49342



49519

### 49342 DUNDEE

floor light; steel, mint, copper-coloured / steel, mint, white  
 Stehleuchte; Stahl, mint, kupferfarben / Stahl, mint, weiss  
 lampadaire; acier, menthe, cuivré / acier, menthe, blanc

H 1355, Base: Ø 600



E27



1x 60W



9 002759 493424

### 49519 CHESTER 1

floor light; steel, rust-coloured, gold  
 Stehleuchte; Stahl, rostfarben, gold  
 lampadaire; acier, rouille, or

H 1495, Base: Ø 600



E27



1x 60W



9 002759 495190



43633



43634

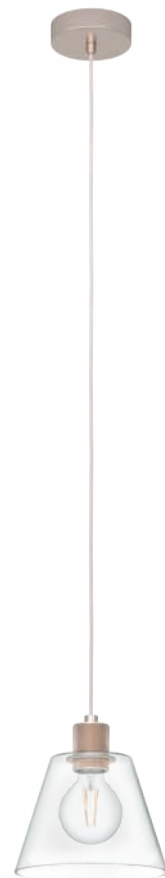

43631

### 43633 COPLEY

pendant light; steel, aluminium, gold-coloured / glass, clear  
Hängeleuchte; Stahl, Alu, goldfarben / Glas, klar  
luminaire en suspension; acier, aluminium, or / verre,  
transparent

H 1100, Ø 200



E27 1x 40W



9 002759 436339



### 43634 COPLEY

pendant light; steel, aluminium, gold-coloured / glass, clear  
Hängeleuchte; Stahl, Alu, goldfarben / Glas, klar  
luminaire en suspension; acier, aluminium, or / verre,  
transparent

L 900, B 200, H 1100



E27 3x 40W



9 002759 436346



### 43631 COPLEY

pendant light; steel, aluminium, rose gold / glass, clear  
Hängeleuchte; Stahl, Alu, roségold / Glas, klar  
luminaire en suspension; acier, aluminium, rose or / verre,  
transparent

H 1100, Ø 200



E27 1x 40W



9 002759 436315

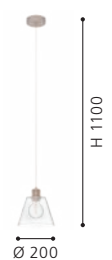





43632

### 43632 COPLEY

pendant light; steel, aluminium, rose gold / glass, clear  
Hängeleuchte; Stahl, Alu, roségold / Glas, klar  
luminaire en suspension; acier, aluminium, rose or / verre,  
transparent

L 900, B 200, H 1100



E27



3x 40W



9 002759 436322

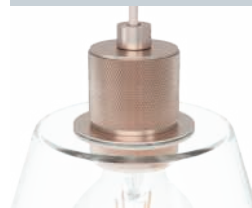

#### DETAIL COPLEY

This luminaires have a special socket.  
Diese Leuchten verfügen über  
eine spezielle Fassung.  
Ces luminaires sont équipés d'une  
douille spéciale.



49736

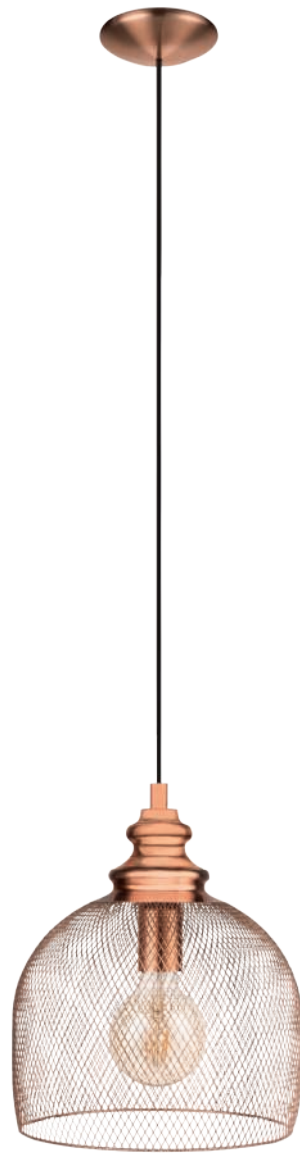

49738

### 49736 STRAITON

pendant light; steel, black  
Hängeleuchte; Stahl, schwarz  
luminaire en suspension; acier, noir

H 1100, Ø 280



E27 1x 60W



9 002759 497361



### 49738 STRAITON

pendant light; steel, copper  
Hängeleuchte; Stahl, kupfer  
luminaire en suspension; acier, cuivre

H 1100, Ø 280



E27 1x 60W



9 002759 497385



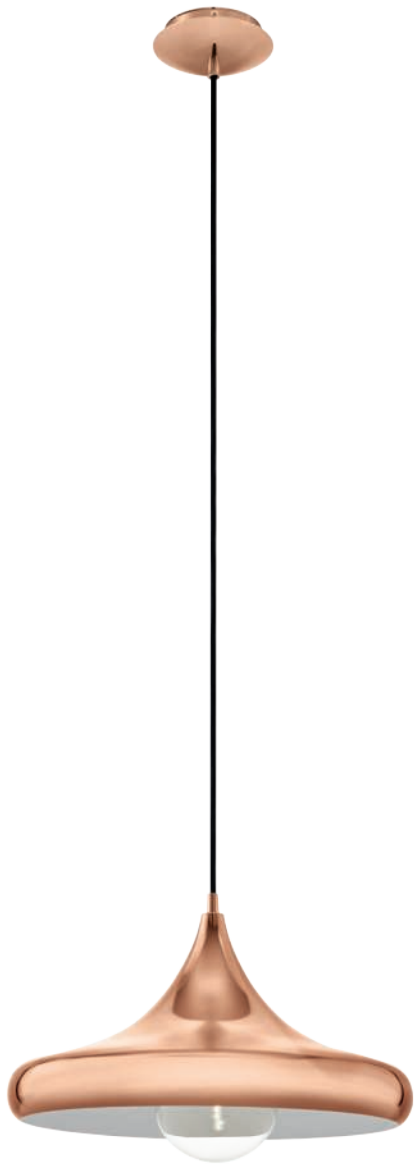

94742

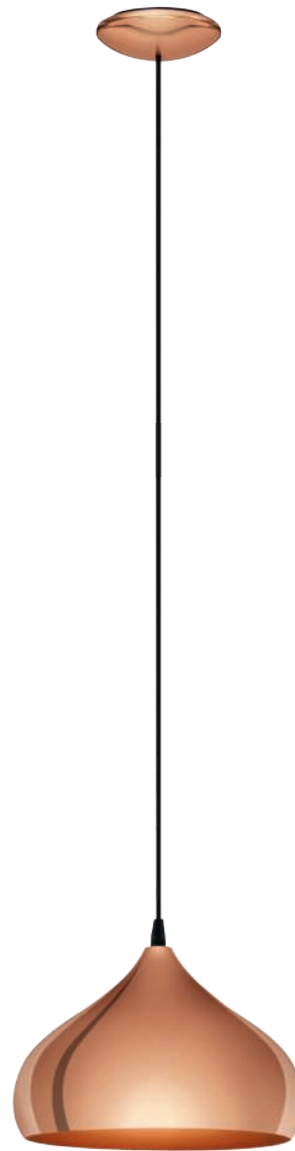

49449

### 94742 CORETTO 2

pendant light; steel, copper  
Hängeleuchte; Stahl, kupfer  
luminaire en suspension; acier, cuivre

H 1100, Ø 400



E27



1x 60W



9 002759 947422

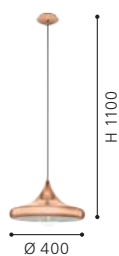

### 49449 HAPTON

pendant light; steel, copper  
Hängeleuchte; Stahl, kupfer  
luminaire en suspension; acier, cuivre

H 1100, Ø 290



E27



1x 60W



9 002759 494490

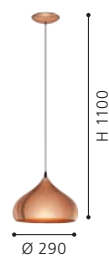



43331



43333

### 43331 WRINGTON

pendant light; steel, black  
Hängeleuchte; Stahl, schwarz  
luminaire en suspension; acier, noir

H 1100, Ø 300



E27



1x 60W



9 002759 433314



### 43333 WRINGTON

pendant light; steel, black  
Hängeleuchte; Stahl, schwarz  
luminaire en suspension; acier, noir

L 740, B 150, H 1100



E27



3x 60W



9 002759 433338

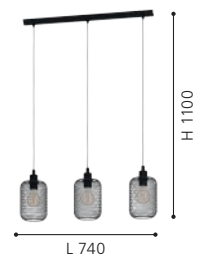



43096



32468

### 43096 WRINGTON

table light; steel, black  
Tischleuchte; Stahl, schwarz  
luminaire de table; acier, noir

H 285, Ø 150, Base: Ø 100



E27



1x 60W



9 002759 430962



### 32468 WRINGTON

floor light; steel, black  
Stehleuchte; Stahl, schwarz  
lampadaire; acier, noir

L 635, B 300, H 1940, Base: Ø 300



E27



1x 60W



9 002759 324681

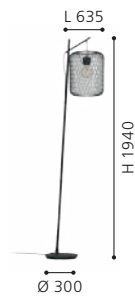



43305



43377

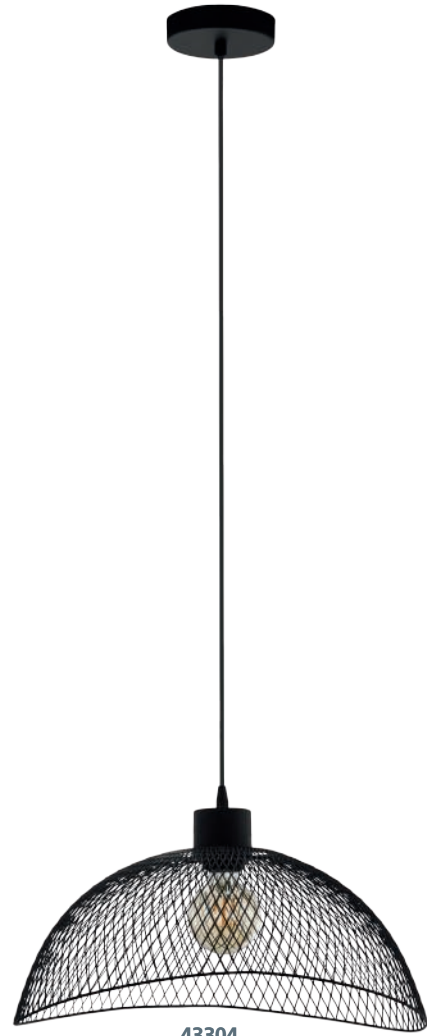

43304

### 43305 POMPEYA

pendant light; steel, black  
Hängeleuchte; Stahl, schwarz  
luminaire en suspension; acier, noir

L 570, B 540, H 1100



E27



1x 60W



9 002759 433055

### 43377 WRINGTON 1

floor light; steel, black  
Stehleuchte; Stahl, schwarz  
lampadaire; acier, noir

L 340, B 305, H 1495, Base: Ø 230



E14



3x 40W

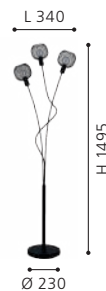

9 002759 433772

### 43304 POMPEYA

pendant light; steel, black  
Hängeleuchte; Stahl, schwarz  
luminaire en suspension; acier, noir

L 450, B 440, H 1100



E27



1x 60W



9 002759 433048



43669



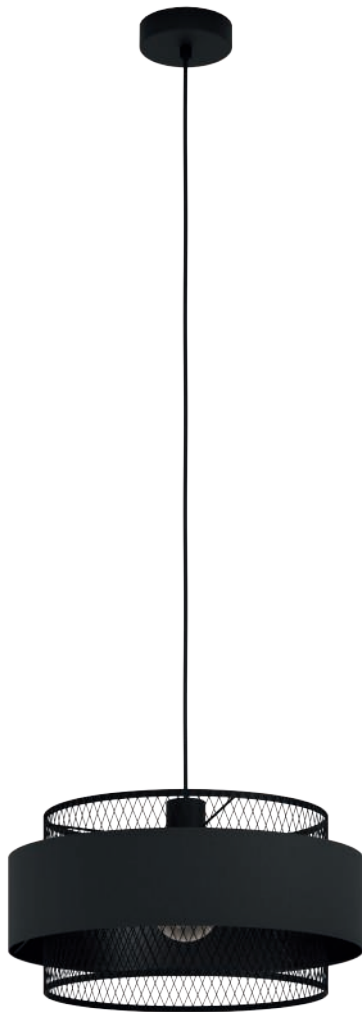

43668



43559

### 43669 BAZELY

pendant light; steel, black / fabric, black  
Hängeleuchte; Stahl, schwarz / Textil, schwarz  
luminaire en suspension; acier, noir / tissu, noir

L 990, B 230, H 1100



E27



3x 40W



9 002759 436698



### 43668 BAZELY

pendant light; steel, black / fabric, black  
Hängeleuchte; Stahl, schwarz / Textil, schwarz  
luminaire en suspension; acier, noir / tissu, noir

H 1100, Ø 400



E27



1x 40W



9 002759 436681

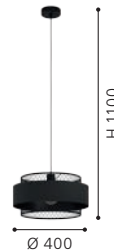

### 43559 SALLICANO

pendant light; steel, black, gold  
Hängeleuchte; Stahl, schwarz, gold  
luminaire en suspension; acier, noir, or

L 730, B 200, H 1100



E27



3x 40W



9 002759 435592





43841

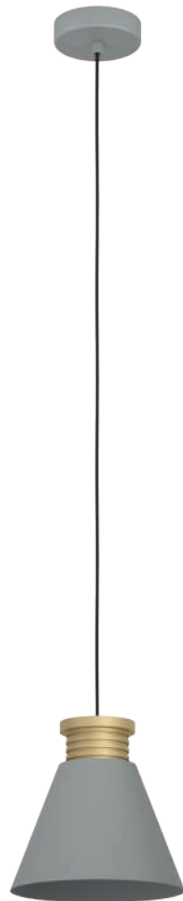

43838



43839

### 43841 TWICKEN

table light; steel, grey, gold  
Tischleuchte; Stahl, grau, gold  
luminaire de table; acier, gris, or

L 155, B 150, H 195, Base: B 155



E27

1x 28W



9 002759 438418



### 43838 TWICKEN

pendant light; steel, grey, gold  
Hängeleuchte; Stahl, grau, gold  
luminaire en suspension; acier, gris, or

H 1100, Ø 220



E27

1x 40W



9 002759 438388



### 43839 TWICKEN

pendant light; steel, grey, gold  
Hängeleuchte; Stahl, grau, gold  
luminaire en suspension; acier, gris, or

L 920, B 220, H 1100



E27

3x 40W



9 002759 438395

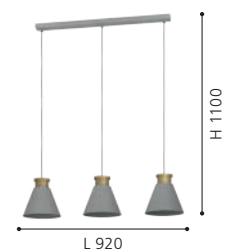



43835

43836



43837

### 43835 TWICKEN

spot; steel, grey, gold  
Spot; Stahl, grau, gold  
spot; acier, gris, or

L 180, B 150, H 200



E27



1x 28W



9 002759 438357

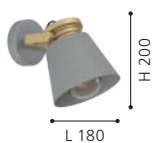

### 43836 TWICKEN

spot; steel, grey, gold  
Spot; Stahl, grau, gold  
spot; acier, gris, or

L 370, B 205, H 175



E27



2x 40W



9 002759 438364

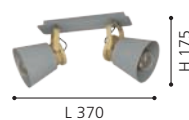

### 43837 TWICKEN

spot; steel, grey, gold  
Spot; Stahl, grau, gold  
spot; acier, gris, or

L 590, B 205, H 175



E27



3x 40W



9 002759 438371





43825



DESIGN  
HIGHLIGHT  
DETAIL

### 43825 MATLOCK

pendant light; steel, grey, black  
Hängeleuchte; Stahl, grau, schwarz  
luminaire en suspension; acier, gris, noir

H 1100, Ø 380



E27



1x 40W



9 002759 438258

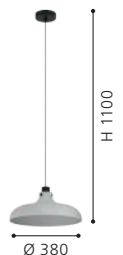

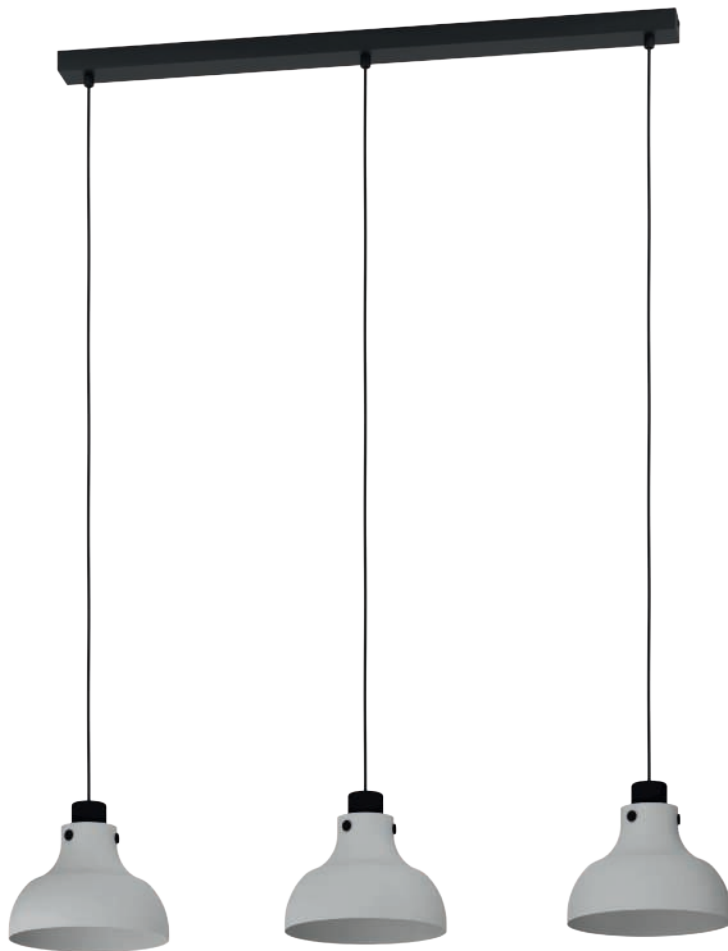

43826



43842

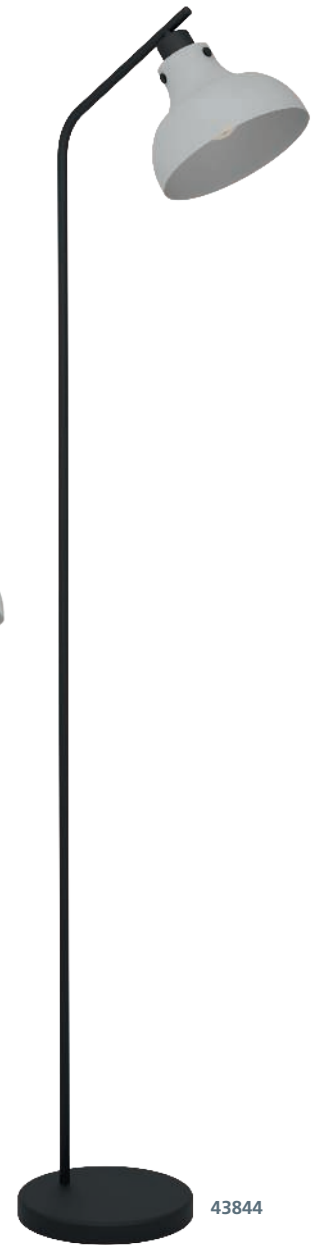

43844

### 43826 MATLOCK

pendant light; steel, grey, black  
 Hängeleuchte; Stahl, grau, schwarz  
 luminaire en suspension; acier, gris, noir

L 900, B 200, H 1100



E27 3x 40W



9 002759 438265

### 43842 MATLOCK

ceiling light; steel, grey, black  
 Deckenleuchte; Stahl, grau, schwarz  
 plafonnier; acier, gris, noir

H 210, Ø 380



E27 1x 40W



9 002759 438425

### 43844 MATLOCK

floor light; steel, grey, black  
 Stehleuchte; Stahl, grau, schwarz  
 lampadaire; acier, gris, noir

L 405, B 200, H 1580, Base: B 230



E27 1x 40W

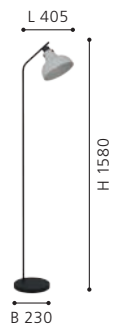

9 002759 438449

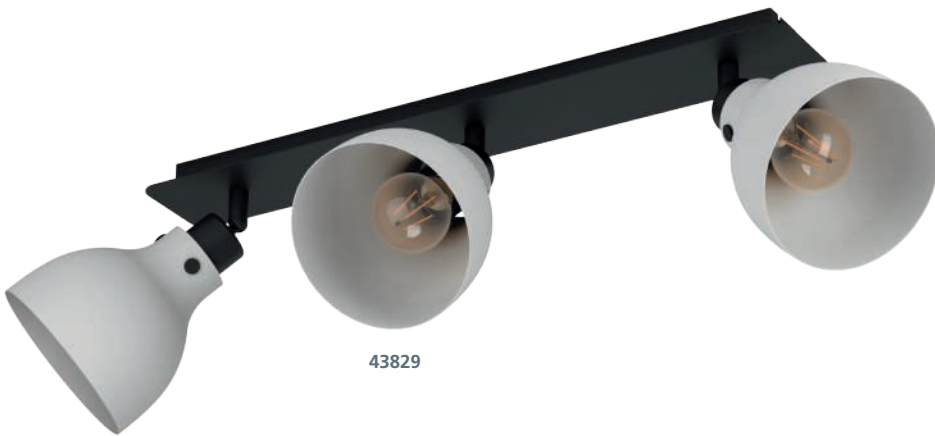

43829



43827



43828

### 43829 MATLOCK

spot; steel, wood, grey, black  
Spot; Stahl, Holz, grau, schwarz  
spot; acier, bois, gris, noir

L 740, B 145, H 225



E27 3x 40W



9 002759 438296



L 740

### 43828 MATLOCK

spot; steel, wood, grey, black  
Spot; Stahl, Holz, grau, schwarz  
spot; acier, bois, gris, noir

L 520, B 145, H 225



E27 2x 40W



9 002759 438289



L 520

### 43827 MATLOCK

spot; steel, grey, black  
Spot; Stahl, grau, schwarz  
spot; acier, gris, noir

L 245, B 145, H 225



E27 1x 40W



9 002759 438272



L 245



43843

### 43843 MATLOCK

wall light; steel, grey, black  
Wandleuchte; Stahl, grau, schwarz  
Applique; acier, gris, noir

L 200, H 250, A 800



E27



1x 40W



9 002759 438432





43595

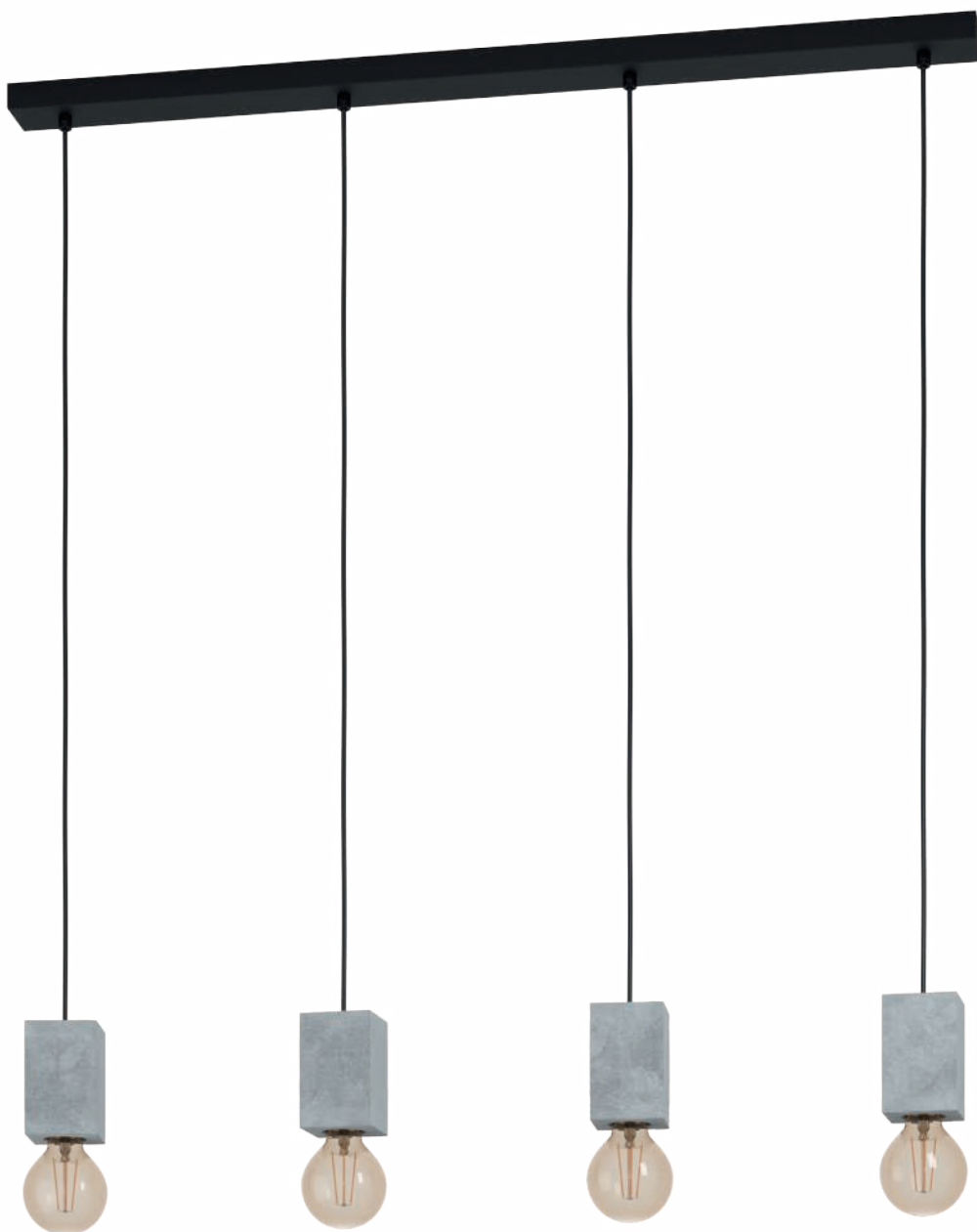

43598

### 43595 PRESTWICK 3

ceiling light; steel, black / concrete, grey  
Deckenleuchte; Stahl, schwarz / Beton, grau  
plafonnier; acier, noir / béton, gris

L 90, B 90, H 110



E27



1x 40W



9 002759 435950



### 43598 PRESTWICK 3

pendant light; steel, black / concrete, grey  
Hängeleuchte; Stahl, schwarz / Beton, grau  
luminaire en suspension; acier, noir / béton, gris

L 925, B 55, H 1100



E27



4x 40W



9 002759 435981

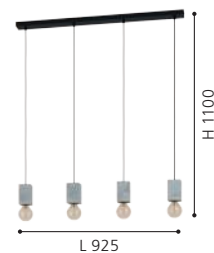





43597



43596

### 43597 PRESTWICK 3

pendant light; steel, black / concrete, grey  
 Hängeleuchte; Stahl, schwarz / Beton, grau  
 luminaire en suspension; acier, noir / béton, gris

H 1100, Ø 70



E27



1x 40W



9 002759 435974



### 43596 PRESTWICK 3

ceiling light; steel, black / concrete, grey  
 Deckenleuchte; Stahl, schwarz / Beton, grau  
 plafonnier; acier, noir / béton, gris

L 490, B 90, H 110



E27



3x 40W



9 002759 435967

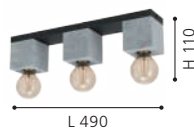



49812



49111

### 49812 PRESTWICK

table light; ceramic, grey  
Tischleuchte; Keramik, grau  
luminaire de table; céramique, gris

L 90, B 90, H 130



E27 1x 60W



9 002759 498122



### 49111 LYNTON

table light; concrete, grey  
Tischleuchte; Beton, grau  
luminaire de table; béton, gris

H 270, Ø 140



E27 1x 60W



9 002759 491116



### 43615 FRIJOLAS

table light; steel, black  
Tischleuchte; Stahl, schwarz  
luminaire de table; acier, noir

L 240, B 30, H 245, Base: Ø 120

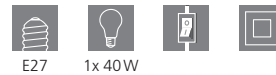

E27 1x 40W



9 002759 436155





43615

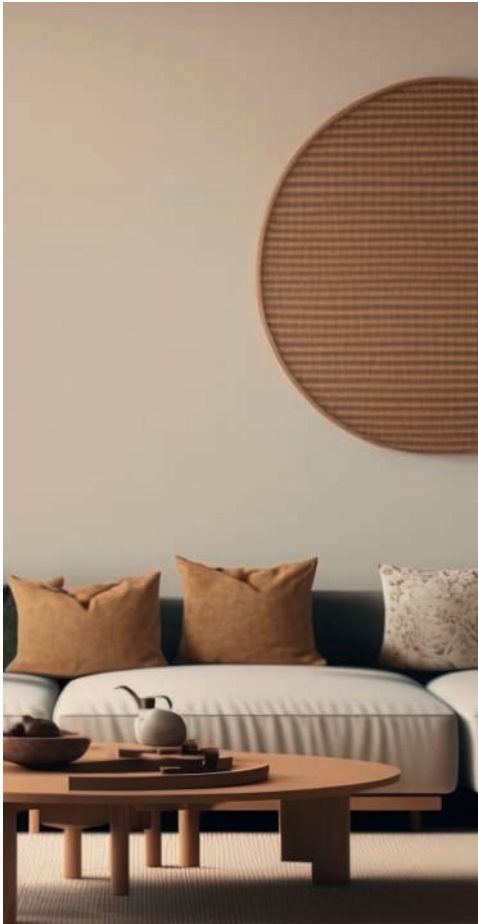

# JAPANDI

#PEACE  
#ROOTS

Japanese interior style is characterized primarily by minimalism, with natural materials and colors. The roots of this trend reach far into the past and are based on long tradition. Craftsmanship has always been appreciated. The popularity of the style led to its combination with other trends, such as Scandinavian design, in recent years. In summary, peaceful simplicity, balance and the natural beauty count.

Der japanische Einrichtungstil ist vor allem durch Minimalismus, natürliche Materialien und Farben gekennzeichnet. Die Wurzeln dieses Trends reichen weit in die Vergangenheit zurück und beruhen auf einer langen Tradition. Handwerkliches Können wurde schon immer geschätzt. Die Beliebtheit des Stils führte in den letzten Jahren zu seiner Kombination mit anderen Trends, wie dem skandinavischen Design. Zusammenfassend lässt sich sagen, dass friedliche Einfachheit, Ausgewogenheit und die natürliche Schönheit zählen.

Le style d'intérieur japonais se caractérise principalement par le minimalisme, avec des matériaux et des couleurs naturels. Les racines de cette tendance remontent loin dans le passé et reposent sur une longue tradition. Le savoir-faire artisanal a toujours été apprécié. La popularité de ce style a conduit à sa combinaison avec d'autres tendances, comme le design scandinave, ces dernières années. En résumé, la simplicité paisible, l'équilibre et la beauté naturelle comptent.



OXPARK  
196-197



BUTTERBURN  
198-199



MINTING  
201



ALSAGER  
202-203



BARLASTON  
204-205

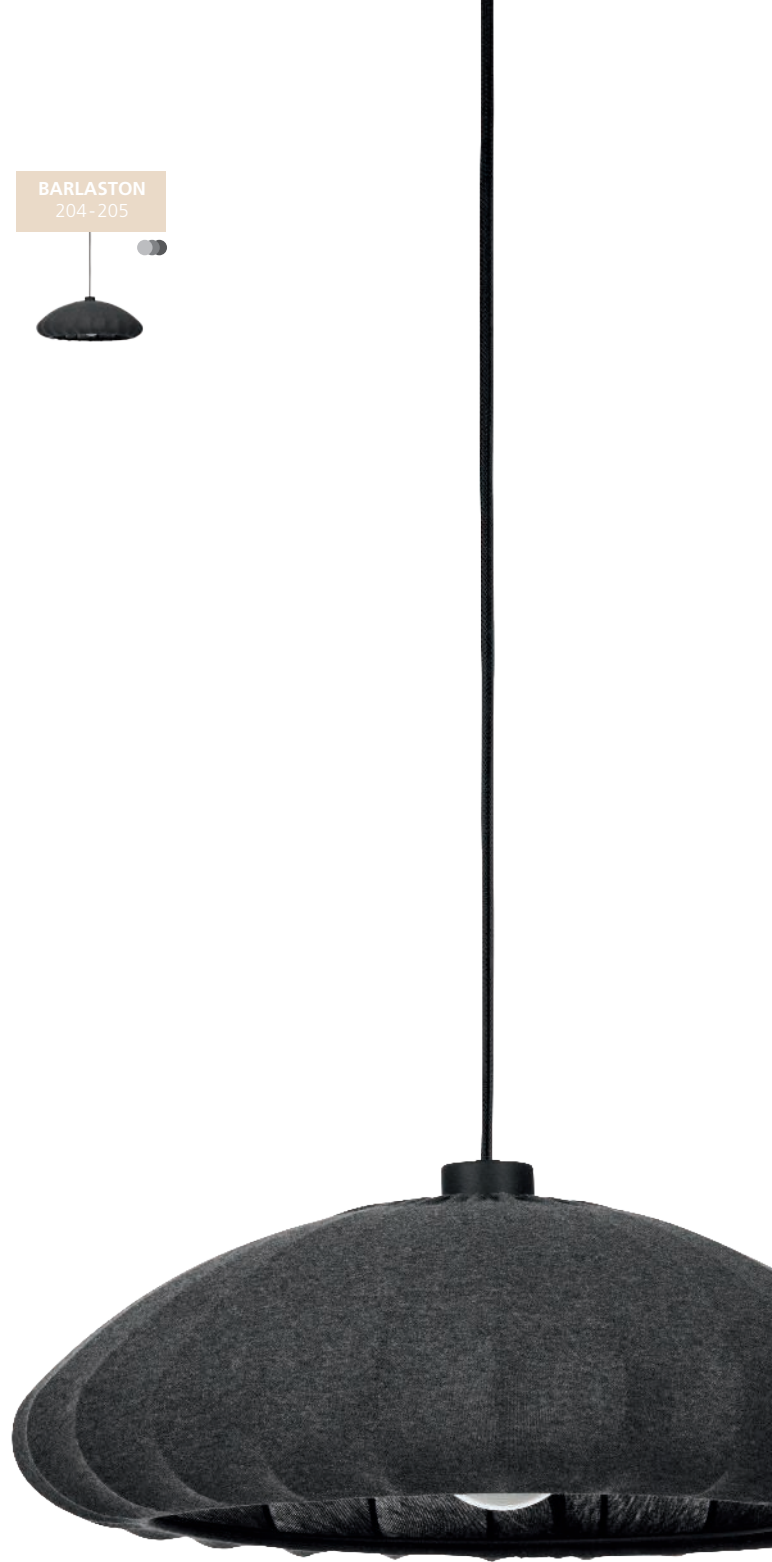

This product is available in different colors and shapes./ Dieser Artikel ist in unterschiedlichen Farben und Formen verfügbar.  
Cet article est disponible en différentes couleurs et formes.



# PURE

COLLECTION



43943

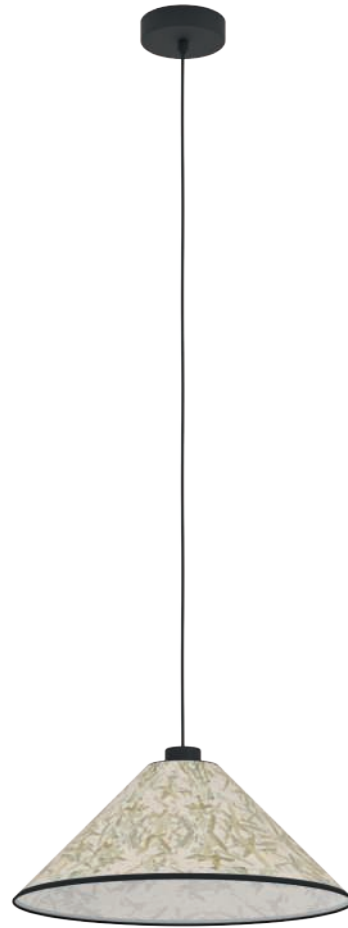

43942



43941

## 43943 OXPARK

pendant light; steel, black / fabric with bamboo leaves, white, green

Hängeleuchte; Stahl, schwarz / Textil mit Bambusblättern, weiss, grün

luminaire en suspension; acier, noir / tissu avec des feuilles de bam, blanc, vert

L 920, B 220, H 1100



E27



3x 25W



9 002759 439439



## 43942 OXPARK

pendant light; steel, black / fabric with bamboo leaves, white, green

Hängeleuchte; Stahl, schwarz / Textil mit Bambusblättern, weiss, grün

luminaire en suspension; acier, noir / tissu avec des feuilles de bam, blanc, vert

H 1100, Ø 420



E27



1x 25W



9 002759 439422



## 43941 OXPARK

ceiling light; steel, black / fabric with bamboo leaves, white, green

Deckenleuchte; Stahl, schwarz / Textil mit Bambusblättern, weiss, grün

plafonnier; acier, noir / tissu avec des feuilles de bam, blanc, vert

H 195, Ø 420



E27



1x 25W



9 002759 439415





43944

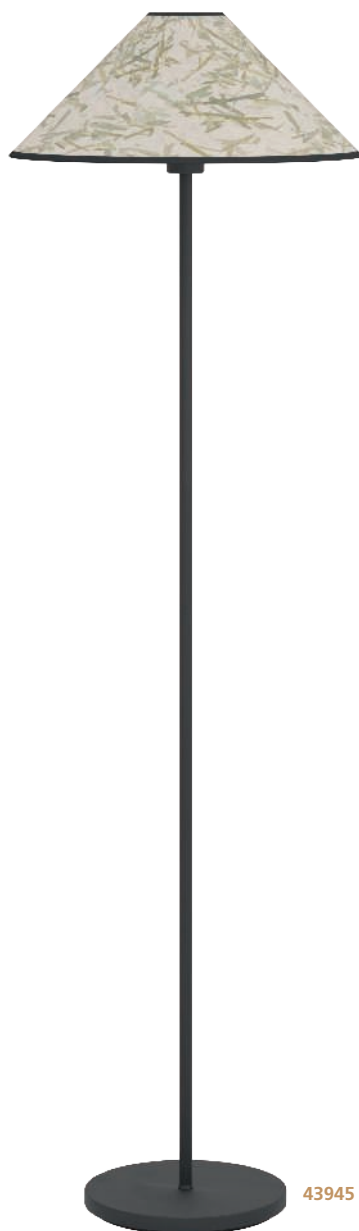

43945

DESIGN  
HIGHLIGHT  
DETAIL



#### DETAIL OXPARK

Dried bamboo leaves on flax fleece - a piece of nature for your own four walls.

Getrocknete Bambusblätter auf Flachsvlies - ein Stück Natur für Ihre eigenen vier Wände.

Des feuilles de bambou séchées sur un voile de lin - un morceau de nature pour vos propres murs.

#### 43944 OXPARK

table light; steel, black / fabric with bamboo leaves, white, green

Tischleuchte; Stahl, schwarz / Textil mit Bambusblättern, weiss, grün

luminaire de table; acier, noir / tissu avec des feuilles de bam, blanc, vert

H 415, Ø 220, Base: Ø 145



E27



1x 25W



Ø 220



H 415

Ø 145



9 002759 439446

#### 43945 OXPARK

floor light; steel, black / fabric with bamboo leaves, white, green

Stehleuchte; Stahl, schwarz / Textil mit Bambusblättern, weiss, grün

lampadaire; acier, noir / tissu avec des feuilles de bam, blanc, vert

H 1465, Ø 420, Base: Ø 250



E27



1x 25W



Ø 420



H 1465

Ø 250



9 002759 439453



43939

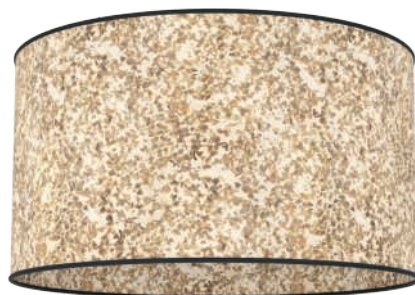

43935



43938

### 43939 BUTTERBURN

floor light; steel, black / fabric with birch leaves, beige, green  
 Stehleuchte; Stahl, schwarz / Textil mit Birkenblättern, beige, grün  
 lampadaire; acier, noir / tissu avec des feuilles de bou, beige, vert

H 1620, Ø 360, Base: Ø 320



9 002759 439392

### 43938 BUTTERBURN

table light; steel, black / fabric with birch leaves, beige, green  
 Tischleuchte; Stahl, schwarz / Textil mit Birkenblättern, beige, grün  
 luminaire de table; acier, noir / tissu avec des feuilles de bou, beige, vert

H 475, Ø 180, Base: Ø 180



9 002759 439385

### 43935 BUTTERBURN

ceiling light; steel, black / fabric with birch leaves, beige, green  
 Deckenleuchte; Stahl, schwarz / Textil mit Birkenblättern, beige, grün  
 plafonnier; acier, noir / tissu avec des feuilles de bou, beige, vert

H 235, Ø 380



9 002759 439354



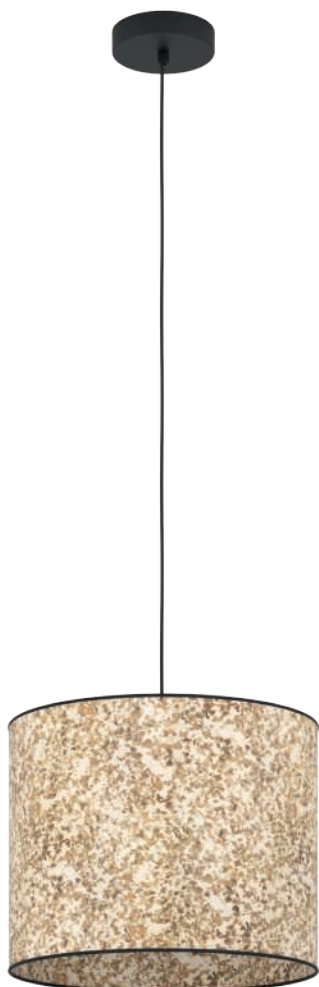

43936



43937

### 43936 BUTTERBURN

pendant light; steel, black / fabric with birch leaves, beige, green

Hängeleuchte; Stahl, schwarz / Textil mit Birkenblättern, beige, grün

luminaire en suspension; acier, noir / tissu avec des feuilles de bou, beige, vert

H 1100, Ø 360



E27



1x 25W



9 002759 439361

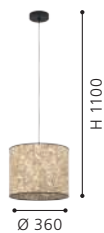

### 43937 BUTTERBURN

pendant light; steel, black / fabric with birch leaves, beige, green

Hängeleuchte; Stahl, schwarz / Textil mit Birkenblättern, beige, grün

luminaire en suspension; acier, noir / tissu avec des feuilles de bou, beige, vert

L 860, B 180, H 1100



E27



3x 25W



9 002759 439378

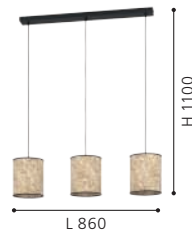

DESIGN  
HIGHLIGHT  
DETAIL

#### DETAIL BUTTERBURN

Dried birch leaves on flax fleece - a piece of nature for your own four walls

Getrocknete Birkenblätter auf Flachsvlies - ein Stück Natur für Ihre eigenen vier Wände

Feuilles de bouleau séchées sur voile de lin - un peu de nature pour vos propres murs



43933



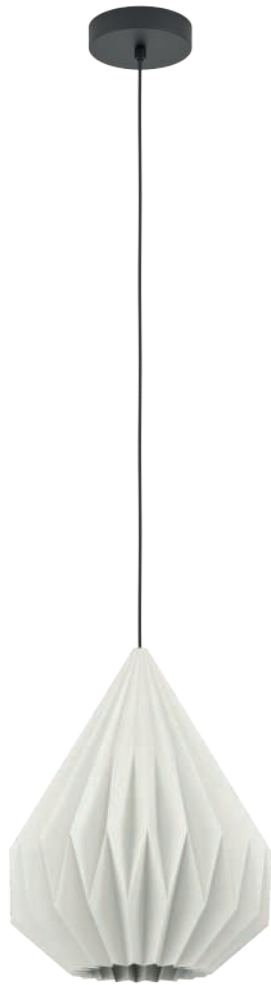

43932

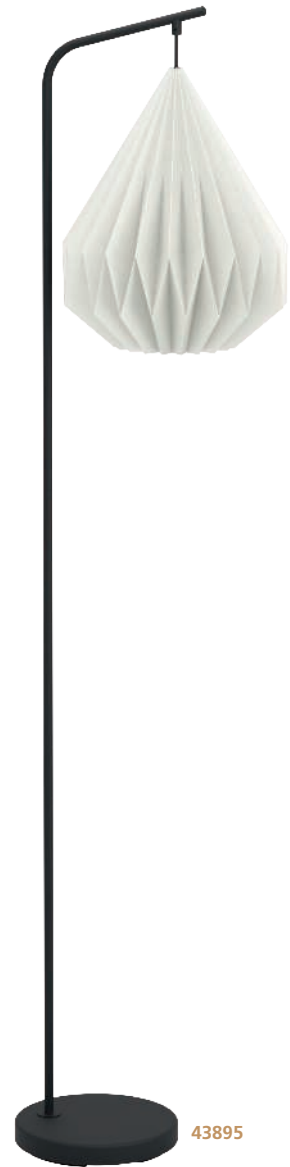

43895

### 43933 MINTING

pendant light; steel, black / paper, white  
 Hängeleuchte; Stahl, schwarz / Papier, weiss  
 luminaire en suspension; acier, noir / papier, blanc

H 1100, Ø 450



E27 1x 25W



9 002759 439330



### 43932 MINTING

pendant light; steel, black / paper, white  
 Hängeleuchte; Stahl, schwarz / Papier, weiss  
 luminaire en suspension; acier, noir / papier, blanc

H 1100, Ø 310



E27 1x 25W



9 002759 439323



### 43895 MINTING

floor light; steel, black / paper, white  
 Stehleuchte; Stahl, schwarz / Papier, weiss  
 lampadaire; acier, noir / papier, blanc

L 365, B 300, H 1585, Base: Ø 230



E27 1x 40W



9 002759 438951



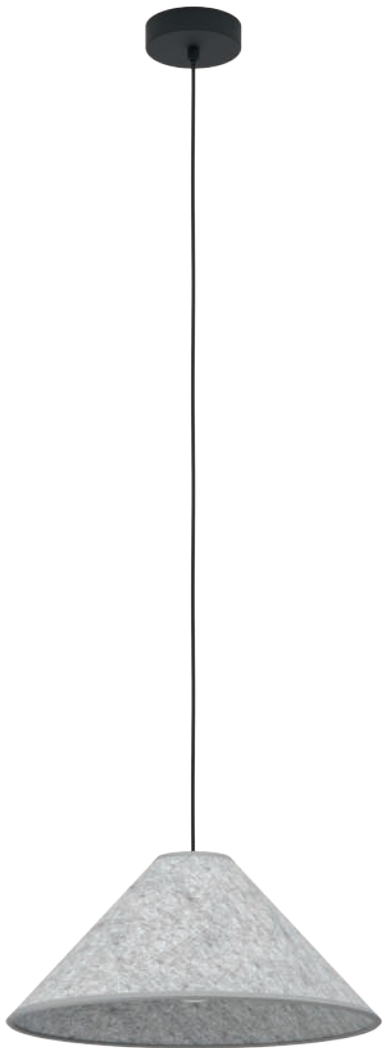

43984



43985

### 43984 ALSAGER

pendant light; steel, black / felt, grey  
 Hängeleuchte; Stahl, schwarz / Filz, grau  
 luminaire en suspension; acier, noir / feutre, gris

H 1100, Ø 410



E27 1x 40W



9 002759 439842

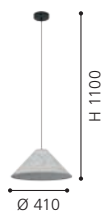

### 43985 ALSAGER

pendant light; steel, black / felt, grey  
 Hängeleuchte; Stahl, schwarz / Filz, grau  
 luminaire en suspension; acier, noir / feutre, gris

L 910, B 210, H 1100



E27 3x 40W



9 002759 439859



### 43987 ALSAGER

floor light; steel, black / felt, grey  
 Stehleuchte; Stahl, schwarz / Filz, grau  
 lampadaire; acier, noir / feutre, gris

L 505, B 210, H 1700, Base: Ø 300



E27 1x 40W



9 002759 439873

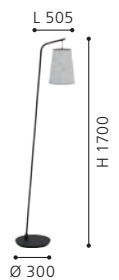



43987



43986

### 43986 ALSAGER

table light; steel, black / felt, grey  
 Tischleuchte; Stahl, schwarz / Filz, grau  
 luminaire de table; acier, noir / feutre, gris

H 395, Ø 200, Base: Ø 150



E27



1x 40W



9 002759 439866

Ø 200



H 395

Ø 150



43961

### 43961 BARLASTON

pendant light; steel, black / fabric, grey  
Hängeleuchte; Stahl, schwarz / Textil, grau  
luminaire en suspension; acier, noir / tissu, gris

H 1100, Ø 450



E27



1x 40W



DESIGN  
HIGHLIGHT  
DETAIL



9 002759 439613





43962



43973

43946

### 43962 BARLASTON

pendant light; steel, black / fabric, grey  
 Hängeleuchte; Stahl, schwarz / Textil, grau  
 luminaire en suspension; acier, noir / tissu, gris

L 880, B 180, H 1100



E27



3x 40W



9 002759 439620



### 43946 BARLASTON

table light; steel, black / fabric, grey  
 Tischleuchte; Stahl, schwarz / Textil, grau  
 luminaire de table; acier, noir / tissu, gris

H 390, Ø 180, Base: Ø 120



E27



1x 40W



9 002759 439460



### 43973 BARLASTON

pendant light; steel, black / fabric, grey  
 Hängeleuchte; Stahl, schwarz / Textil, grau  
 luminaire en suspension; acier, noir / tissu, gris

H 1100, Ø 350



E27



1x 40W



9 002759 439736



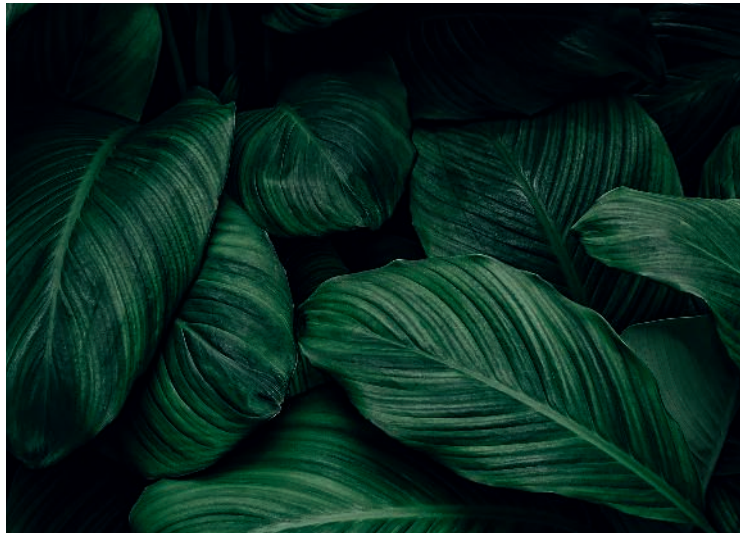

# ! NATURE

#PURE  
#GREEN

Bring the warmth and comfort of natural elements into your home. The back-to-nature trend incorporates designs that use natural materials, harmonious colour combinations, and simple, neutral shapes. A lamp from the EGLO Nature range will increase the comfort of any living space, no matter what interior design style you prefer.

Holen Sie sich pure Gemütlichkeit in Ihr zu Hause, ganz getreu dem Motto „back to nature“. Der Nature-Trend umfasst Designs mit natürlichen Materialien, aufeinander abgestimmten Farbkombinationen und neutralen sowie einfachen Formen. Egal welchen Einrichtungsstil Sie bevorzugen, mit einer EGLO Leuchte aus der Kategorie Nature steigern Sie das Wohlbefinden im Wohnraum.

Faites entrer le confort absolu dans votre maison, fidèle à la devise „retour à la nature“. La tendance nature comprend des designs avec des matériaux naturels, des combinaisons de couleurs coordonnées et des formes neutres et simples. Quel que soit le style d'ameublement que vous préférez, avec une lampe EGLO de la catégorie Nature, vous augmentez le bien-être dans le salon.



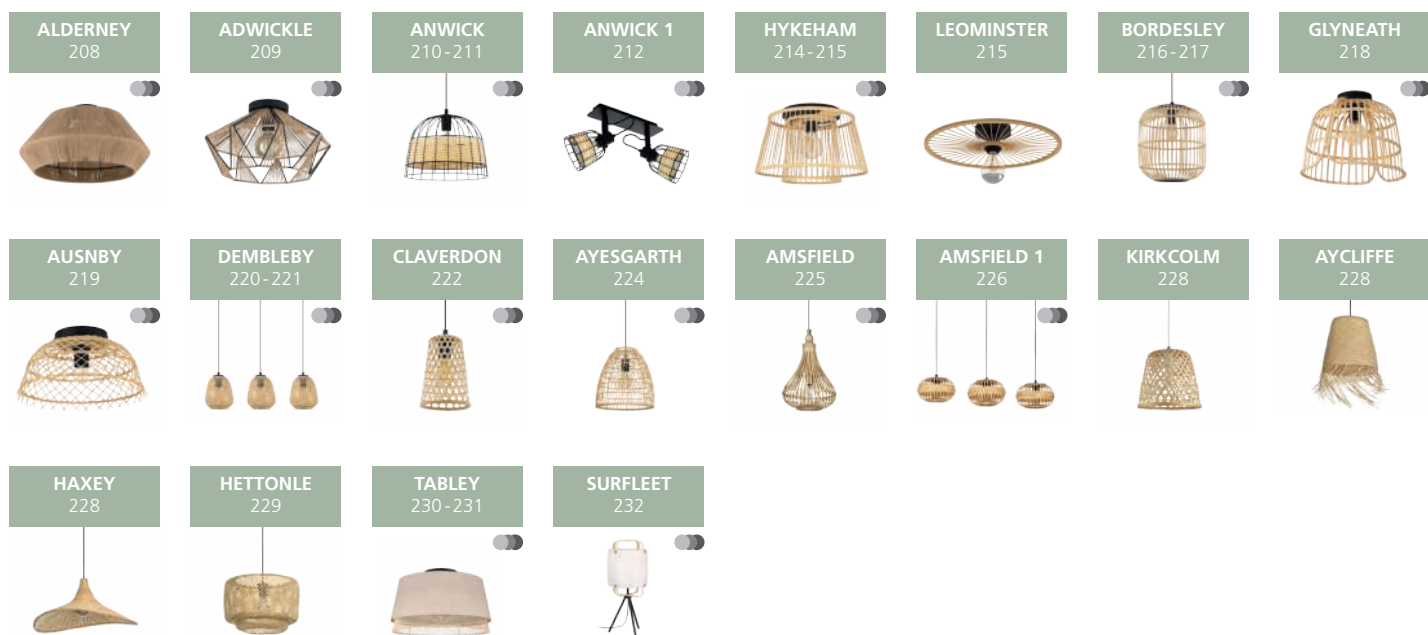

 This product is available in different colors and shapes./ Dieser Artikel ist in unterschiedlichen Farben und Formen verfügbar.  
Cet article est disponible en différentes couleurs et formes.



43785



43784



43786

### 43785 ALDERNEY

pendant light; steel, black / textile thread, natural  
Hängeleuchte; Stahl, schwarz / Textilfaden, natur  
luminaire en suspension; acier, noir / fil textile, nature

H 1100, Ø 300



E27 1x 40W



9 002759 437855



### 43784 ALDERNEY

ceiling light; steel, black / textile thread, natural  
Deckenleuchte; Stahl, schwarz / Textilfaden, natur  
plafonnier; acier, noir / fil textile, nature

H 240, Ø 480



E27 1x 40W



9 002759 437848

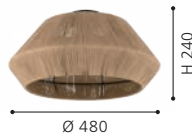

### 43786 ALDERNEY

pendant light; steel, black / textile thread, natural  
Hängeleuchte; Stahl, schwarz / Textilfaden, natur  
luminaire en suspension; acier, noir / fil textile, nature

L 900, B 200, H 1100



E27 3x 40W



9 002759 437862





43775



43777



43776

### 43775 ADWICKLE

ceiling light; steel, black / fabric, natural  
Deckenleuchte; Stahl, schwarz / Textil, natur  
plafonnier; acier, noir / tissu, nature

H 260, Ø 445



E27



1x 40W



9 002759 437756

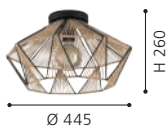

### 43777 ADWICKLE

pendant light; steel, black / fabric, natural  
Hängeleuchte; Stahl, schwarz / Textil, natur  
luminaire en suspension; acier, noir / tissu, nature

L 870, B 145, H 1100



E27



3x 40W



9 002759 437770



### 43776 ADWICKLE

pendant light; steel, black / fabric, natural  
Hängeleuchte; Stahl, schwarz / Textil, natur  
luminaire en suspension; acier, noir / tissu, nature

L 170, B 145, H 1100



E27



1x 40W



9 002759 437763

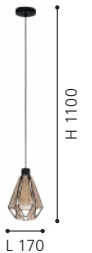

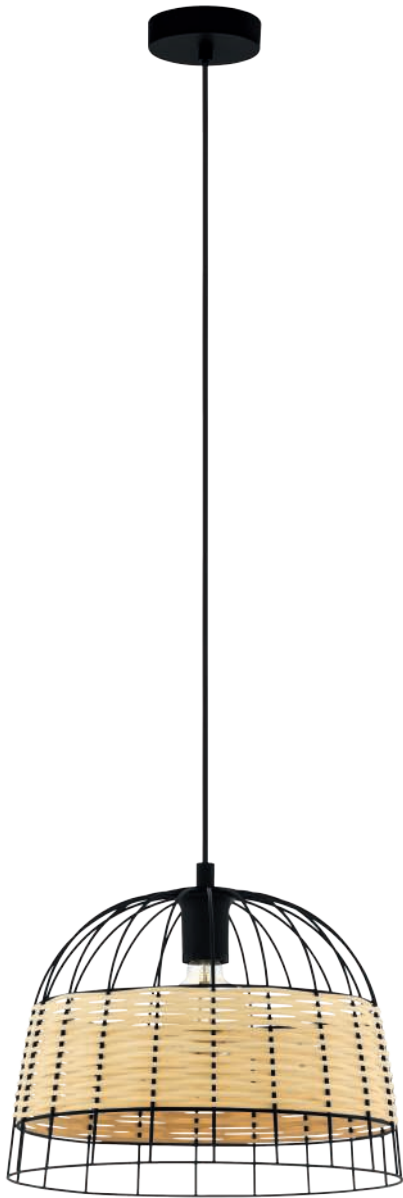

43311



43313

### 43311 ANWICK

pendant light; steel, black / rattan, natural  
 Hängeleuchte; Stahl, schwarz / Rattan, natur  
 luminaire en suspension; acier, noir / rotin, nature

H 1100, Ø 370



E27 1x 40W



### 43313 ANWICK

pendant light; steel, black / rattan, natural  
 Hängeleuchte; Stahl, schwarz / Rattan, natur  
 luminaire en suspension; acier, noir / rotin, nature

L 880, B 180, H 1100



E27 3x 40W





43398



43312



### 43398 ANWICK

ceiling light; steel, black / rattan, natural  
Deckenleuchte; Stahl, schwarz / Rattan, natur  
plafonnier; acier, noir / rotin, nature

H 265, Ø 380



E27



1x 60W



9 002759 433987



### 43312 ANWICK

pendant light; steel, black / rattan, natural  
Hängeleuchte; Stahl, schwarz / Rattan, natur  
luminaire en suspension; acier, noir / rotin, nature

H 1100, Ø 500



E27



1x 40W



9 002759 433123

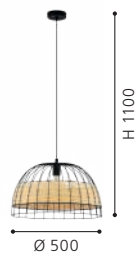



43325



43326

**43325 ANWICK 1**

spot; steel, black / rattan, natural  
 Spot; Stahl, schwarz / Rattan, natur  
 spot; acier, noir / rotin, nature

L 480, B 140, H 240



E27 2x 40W



9 002759 433253

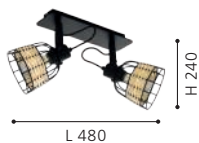

**43326 ANWICK 1**

spot; steel, black / rattan, natural  
 Spot; Stahl, schwarz / Rattan, natur  
 spot; acier, noir / rotin, nature

L 670, B 140, H 240



E27 3x 40W



9 002759 433260

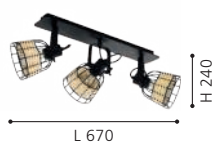

**43324 ANWICK 1**

spot; steel, black / rattan, natural  
 Spot; Stahl, schwarz / Rattan, natur  
 spot; acier, noir / rotin, nature

L 140, H 200



E27 1x 40W



9 002759 433246

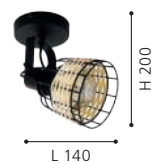



43324





43851



43854



43853

### 43851 HYKEHAM

ceiling light; steel, black / wood, natural  
Deckenleuchte; Stahl, schwarz / Holz, natur  
plafonnier; acier, noir / bois, nature

H 210, Ø 380



E27 1x 40W



9 002759 438517

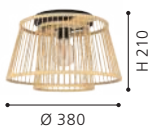

### 43854 HYKEHAM

table light; steel, black / wood, natural  
Tischleuchte; Stahl, schwarz / Holz, natur  
luminaire de table; acier, noir / bois, nature

H 570, Ø 210, Base: Ø 285



E27 1x 40W



9 002759 438548



### 43853 HYKEHAM

pendant light; steel, black / wood, natural  
Hängeleuchte; Stahl, schwarz / Holz, natur  
luminaire en suspension; acier, noir / bois, nature

L 910, B 210, H 1100



E27 3x 40W



9 002759 438531

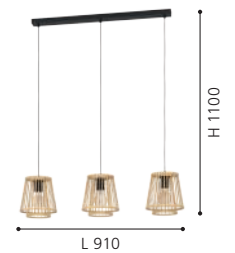





43855

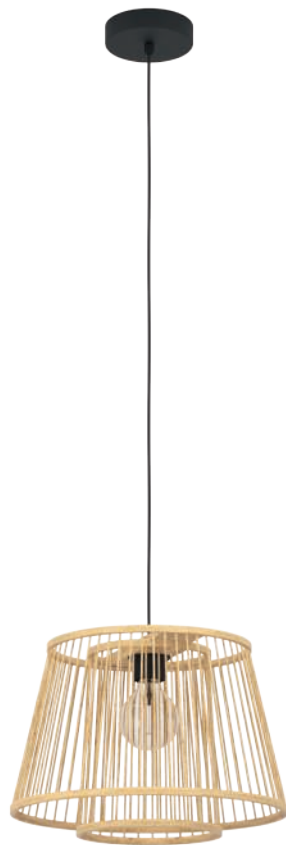

43852



43883



### 43855 HYKEHAM

floor light; steel, black / wood, natural  
 Stehleuchte; Stahl, schwarz / Holz, natur  
 lampadaire; acier, noir / bois, nature

H 1295, Ø 380, Base: Ø 630



E27



1x 40W



9 002759 438555

### 43852 HYKEHAM

pendant light; steel, black / wood, natural  
 Hängeleuchte; Stahl, schwarz / Holz, natur  
 luminaire en suspension; acier, noir / bois, nature

H 1100, Ø 380



E27



1x 40W



9 002759 438524

### 43883 LEOMINSTER

wall / ceiling light; steel, black / wood, natural  
 Wand- / Deckenleuchte; Stahl, schwarz / Holz, natur  
 Applique/Plafonnier; acier, noir / bois, nature

H 90, Ø 450



E27



1x 40W



9 002759 438838

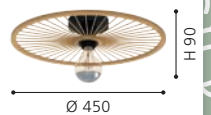



43216



43231



43218

### 43216 BORDESLEY

pendant light; steel, black / wood, natural  
Hängeleuchte; Stahl, schwarz / Holz, natur  
luminaire en suspension; acier, noir / bois, nature

H 1100, Ø 350



E27 1x 28W



9 002759 432164



### 43231 BORDESLEY

pendant light; steel, black / wood, natural  
Hängeleuchte; Stahl, schwarz / Holz, natur  
luminaire en suspension; acier, noir / bois, nature

H 1100, Ø 210



E27 1x 28W



9 002759 432317



### 43218 BORDESLEY

table light; steel, black / wood, natural  
Tischleuchte; Stahl, schwarz / Holz, natur  
luminaire de table; acier, noir / bois, nature

H 400, Ø 210, Base: Ø 190



E27 1x 28W



9 002759 432188





43217

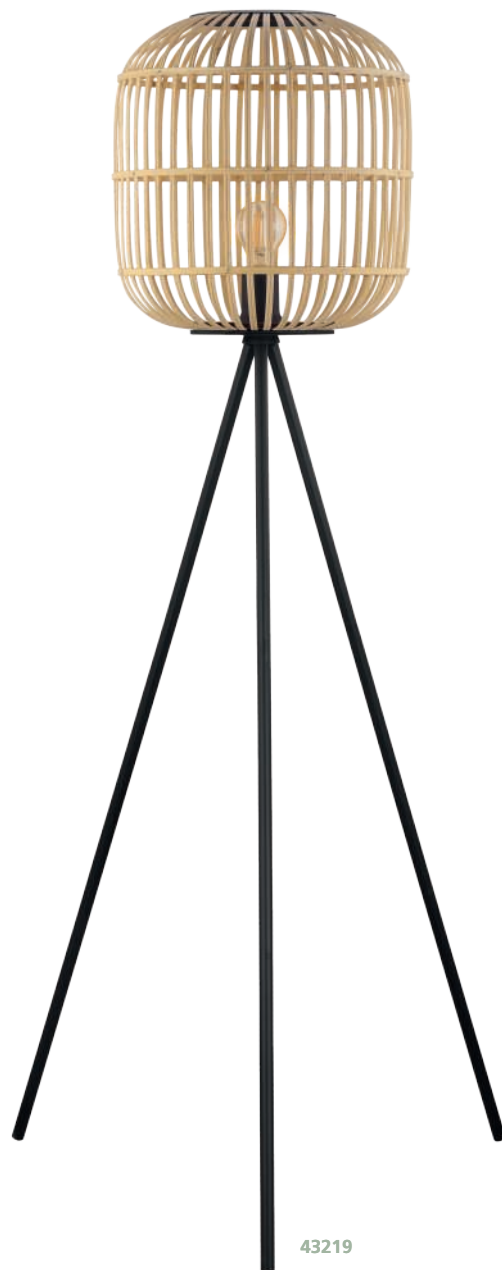

43219

### 43217 BORDESLEY

pendant light; steel, black / wood, natural  
 Hängeleuchte; Stahl, schwarz / Holz, natur  
 luminaire en suspension; acier, noir / bois, nature

L 910, B 210, H 1100



E27



3x 28W



9 002759 432171

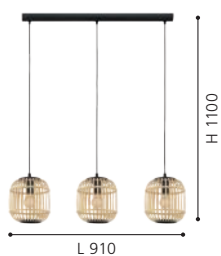

### 43219 BORDESLEY

floor light; steel, black / wood, natural  
 Stehleuchte; Stahl, schwarz / Holz, natur  
 lampadaire; acier, noir / bois, nature

H 1390, Ø 350, Base: Ø 560



E27



1x 28W



9 002759 432195





43872

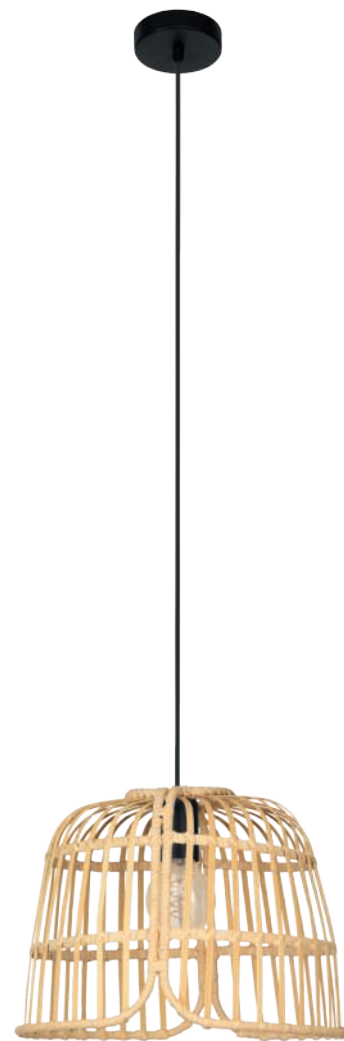

43873

### 43872 GLYNEATH

ceiling light; steel, black / wood, natural  
Deckenleuchte; Stahl, schwarz / Holz, natur  
plafonnier; acier, noir / bois, nature

H 205, Ø 375



E27



1x 40W



9 002759 438722



### 43873 GLYNEATH

pendant light; steel, black / wood, natural  
Hängeleuchte; Stahl, schwarz / Holz, natur  
luminaire en suspension; acier, noir / bois, nature

H 1100, Ø 375



E27



1x 40W



9 002759 438739





43831



43285

### 43831 AUSNBY

ceiling light; steel, black / wood, natural  
Deckenleuchte; Stahl, schwarz / Holz, natur  
plafonnier; acier, noir / bois, nature

H 200, Ø 370



E27



1x 40W



9 002759 438319

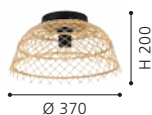

### 43285 AUSNBY

pendant light; steel, black / wood, natural  
Hängeleuchte; Stahl, schwarz / Holz, natur  
luminaire en suspension; acier, noir / bois, nature

H 1100, Ø 370



E27



1x 40W



9 002759 432850





43262



43263

### 43262 DEMBLEBY

pendant light; steel, black / wood, natural  
 Hängeleuchte; Stahl, schwarz / Holz, natur  
 luminaire en suspension; acier, noir / bois, nature

L 900, B 200, H 1100



E27



3x 40W



9 002759 432621



### 43263 DEMBLEBY

table light; steel, black / wood, natural  
 Tischleuchte; Stahl, schwarz / Holz, natur  
 luminaire de table; acier, noir / bois, nature

H 250, Ø 200, Base: Ø 115



E27



1x 40W



9 002759 432638



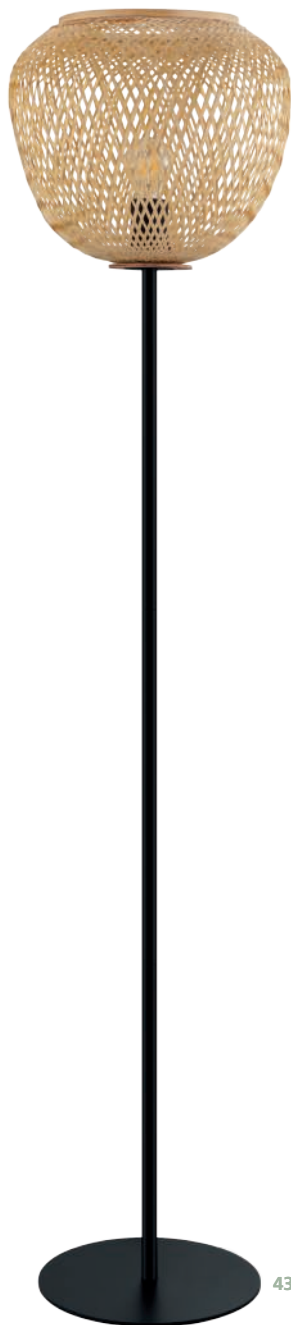

43264



43261

### 43264 DEMBLEBY

floor light; steel, black / wood, natural  
 Stehleuchte; Stahl, schwarz / Holz, natur  
 lampadaire; acier, noir / bois, nature

H 1500, Ø 320, Base: Ø 275



E27



1x 40W



Ø 320



H 1500



Ø 275



9 002759 432645

### 43261 DEMBLEBY

pendant light; steel, black / wood, natural  
 Hängeleuchte; Stahl, schwarz / Holz, natur  
 luminaire en suspension; acier, noir / bois, nature

H 1100, Ø 320



E27



1x 40W



H 1100



Ø 320



9 002759 432614



43252



43254

### 43252 CLAVERDON

pendant light; steel, black / wood, natural  
Hängeleuchte; Stahl, schwarz / Holz, natur  
luminaire en suspension; acier, noir / bois, nature

H 1100, Ø 180



E27 1x 40W



9 002759 432522

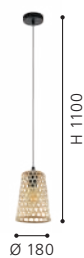

### 43254 CLAVERDON

pendant light; steel, black / wood, natural  
Hängeleuchte; Stahl, schwarz / Holz, natur  
luminaire en suspension; acier, noir / bois, nature

H 1100, Ø 495



E27 1x 40W



9 002759 432546



### 43253 CLAVERDON

pendant light; steel, black / wood, natural  
Hängeleuchte; Stahl, schwarz / Holz, natur  
luminaire en suspension; acier, noir / bois, nature

H 1100, Ø 370



E27 1x 40W



9 002759 432539







43253



43866



43867

### 43866 AYESGARTH

pendant light; steel, black / wood, natural  
 Hängeleuchte; Stahl, schwarz / Holz, natur  
 luminaire en suspension; acier, noir / bois, nature

H 1100, Ø 330



E27 1x 40W



9 002759 438661



### 43867 AYESGARTH

pendant light; steel, black / wood, natural  
 Hängeleuchte; Stahl, schwarz / Holz, natur  
 luminaire en suspension; acier, noir / bois, nature

L 910, B 210, H 1100



E27 3x 40W



9 002759 438678





49772



43723



49771

### 49772 AMSFIELD

pendant light; steel, brown / wood, brown  
 Hängeleuchte; Stahl, braun / Holz, braun  
 luminaire en suspension; acier, marron / bois, marron

H 1100, Ø 350



E27



1x 60W



9 002759 497729



### 43723 AMSFIELD

ceiling light; steel, black / wood, brown  
 Deckenleuchte; Stahl, schwarz / Holz, braun  
 plafonnier; acier, noir / bois, marron

H 285, Ø 450



E27



1x 40W



9 002759 437237



### 49771 AMSFIELD

pendant light; steel, brown / wood, brown  
 Hängeleuchte; Stahl, braun / Holz, braun  
 luminaire en suspension; acier, marron / bois, marron

H 1100, Ø 380



E27



1x 60W



9 002759 497712





43863



43864

### 43863 AMSFIELD 1

pendant light; steel, black / wood, natural  
Hängeleuchte; Stahl, schwarz / Holz, natur  
luminaire en suspension; acier, noir / bois, nature

L 960, B 260, H 1100



E27 3x 40W



9 002759 438630



### 43864 AMSFIELD 1

pendant light; steel, black / wood, natural  
Hängeleuchte; Stahl, schwarz / Holz, natur  
luminaire en suspension; acier, noir / bois, nature

H 1100, Ø 480



E27 3x 40W



9 002759 438647



### 43865 AMSFIELD 1

table light; steel, black / wood, natural  
Tischleuchte; Stahl, schwarz / Holz, natur  
luminaire de table; acier, noir / bois, nature

H 410, Ø 260, Base: Ø 200

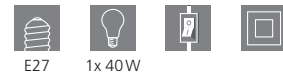

E27 1x 40W



9 002759 438654

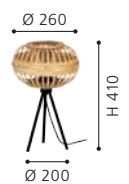



43865



43113

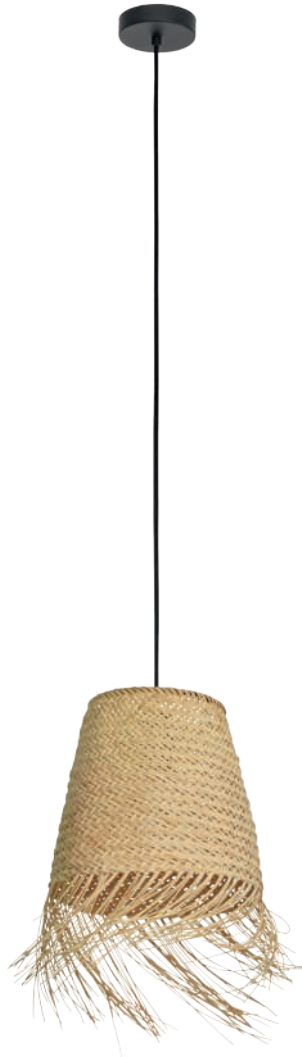

43871

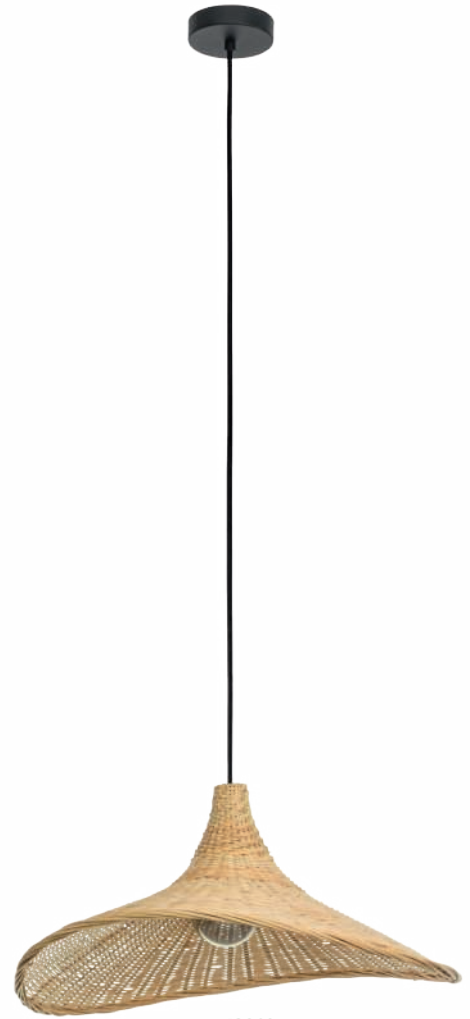

43869

### 43113 KIRKCOLM

pendant light; steel, satin nickel / wood, natural  
Hängeleuchte; Stahl, nickel-matt / Holz, natur  
luminaire en suspension; acier, nickel mat / bois, nature

H 1100, Ø 300



E27 1x 60W



9 002759 431136



### 43871 AYCLIFFE

pendant light; steel, black / wood, natural  
Hängeleuchte; Stahl, schwarz / Holz, natur  
luminaire en suspension; acier, noir / bois, nature

H 1100, Ø 300



E27 1x 40W



9 002759 438715



### 43869 HAXEY

pendant light; steel, black / wood, natural  
Hängeleuchte; Stahl, schwarz / Holz, natur  
luminaire en suspension; acier, noir / bois, nature

H 1100, Ø 500



E27 1x 40W



9 002759 438692

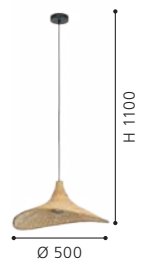



43868

### 43868 HETTONLE

pendant light; steel, black / wood, natural  
Hängeleuchte; Stahl, schwarz / Holz, natur  
luminaire en suspension; acier, noir / bois, nature

H 1100, Ø 420



E27



1x 40W



9 002759 438685





43974



43977



43978

### 43974 TABLEY

ceiling light; steel, black / fabric, wood, nature, brown  
Deckenleuchte; Stahl, schwarz / Textil, Holz, natur, braun  
plafonnier; acier, noir / tissu, bois, nature, marron

H 235, Ø 380



E27 1x 40W



9 002759 439743

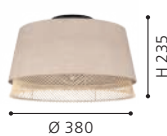

### 43977 TABLEY

table light; steel, black / fabric, wood, nature, brown  
Tischleuchte; Stahl, schwarz / Textil, Holz, natur, braun  
luminaire de table; acier, noir / tissu, bois, nature, marron

H 425, Ø 190, Base: Ø 145



E27 1x 40W



9 002759 439774



### 43978 TABLEY

floor light; steel, black / fabric, wood, nature, brown  
Stehleuchte; Stahl, schwarz / Textil, Holz, natur, braun  
lampadaire; acier, noir / tissu, bois, nature, marron

H 1530, Ø 380, Base: Ø 250



E27 1x 40W



9 002759 439781







43976



43975

### 43976 TABLEY

pendant light; steel, black / fabric, wood, nature, brown  
 Hängeleuchte; Stahl, schwarz / Textil, Holz, natur, braun  
 luminaire en suspension; acier, noir / tissu, bois, nature, marron

L 890, B 190, H 1100



E27



3x 40W



9 002759 439767



### 43975 TABLEY

pendant light; steel, black / fabric, wood, nature, brown  
 Hängeleuchte; Stahl, schwarz / Textil, Holz, natur, braun  
 luminaire en suspension; acier, noir / tissu, bois, nature, marron

H 1100, Ø 380



E27



1x 40W



9 002759 439750





DESIGN  
HIGHLIGHT  
DETAIL



43934

### 43934 SURFLEET

table light; steel, black / wood, fabric, natural  
Tischleuchte; Stahl, schwarz / Holz, Textil, natur  
luminaire de table; acier, noir / bois, tissu, nature

H 515, Ø 200, Base: Ø 210



E27

1x 40W



9 002759 439347



### 43874 SURFLEET

pendant light; steel, black / wood, fabric, natural  
Hängeleuchte; Stahl, schwarz / Holz, Textil, natur  
luminaire en suspension; acier, noir / bois, tissu, nature

H 1100, Ø 330



E27

1x 40W



9 002759 438746





43874



# ! COTTAGE CHIC

## #BRITISH #TEATIME

It's tea o'clock – the famous tea time shouldn't be limited to Brits. Interrupt the rhythm of your day, take a deep breath and enjoy a few moments of calm. It will feel so good! Best do it with a cup of tea in a British-style atmosphere, glass, brilliant glass, flower patterns and luminaires that are presented as decorative pieces. EGLO will bring a piece of British Cottage Chic to your home without having to travel at all.

It's tea o'clock – die berühmte Tee-pause sollten sich nicht nur die Briten gönnen. Unterbrechen Sie Ihren Tagesrhythmus, atmen Sie tief durch und genießen Sie ein paar Momente der Stille. Wie gut das tut! Am besten in british angehauchter Atmosphäre mit einer Tasse Tee in der Hand. Keramik, Glas, Brillantglas, Blümchendeckor und Leuchten, die sich als Dekostücke präsentieren. Ohne Reisen erhalten Sie mit EGLO ein Stück britischen Cottage Chic für Ihr Zuhause.

It's tea o'clock (Il est l'heure du thé) – la cé-lèbre pause thé ne doit pas uniquement être destiné aux britanniques. Interrompez votre rythme quotidien, respirez profondément et régalez-vous de quelques instants de silence. Combien de bien cela peut faire ! Le mieux serait de faire cela dans une atmosphère à inspiration britannique, ayant une tasse de thé à la main. De la céramique, du verre, du verre brillant, des décorations à fleurs et des luminaires, se présentant en tant que pièces décoratives. Grâce à EGLO, vous obtenez un peu de Cottage Chics britannique pour votre maison, sans même devoir voyager.



EDALE  
236



ARNHEM  
238-239



MEDIOUNA  
239



KILBURN  
241



BRADFORD  
242



BRADFORD 1  
243



KENSAL  
245



NIMLET  
245



KINROSS  
246



HAMBLETON  
246



CAPOSILE  
246



TOWNSHEND 2  
247



This product is available in different colors and shapes./ Dieser Artikel ist in unterschiedlichen Farben und Formen verfügbar.  
Cet article est disponible en différentes couleurs et formes.



43783



43782



### 43783 EDALE

wall light; steel, wood, black, brown / fabric, cappuccino  
Wandleuchte; Stahl, Holz, schwarz, braun / Textil, cappuccino  
Applique; acier, bois, noir, marron / tissu, cappuccino

L 150, H 215, A 195



E27



1x 40W



9 002759 437831



### 43782 EDALE

pendant light; steel, wood, black, brown / fabric, cappuccino  
Hängeleuchte; Stahl, Holz, schwarz, braun / Textil, cappuccino  
luminaire en suspension; acier, bois, noir, marron / tissu, cappuccino

L 1080, B 510, H 1100



E27



6x 40W



9 002759 437824



### 43781 EDALE

pendant light; steel, wood, black, brown / fabric, cappuccino  
Hängeleuchte; Stahl, Holz, schwarz, braun / Textil, cappuccino  
luminaire en suspension; acier, bois, noir, marron / tissu, cappuccino

H 1100, Ø 700



E27



6x 40W



9 002759 437817

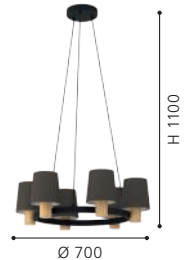



43781





43401

43402

43403

**DETAIL 43403**

The luminaire heads can be installed on the ceiling individually.  
 Die Leuchtenköpfe können individuell an die Decke montiert werden.  
 Les têtes de luminaires peuvent être montées individuellement au plafond.

**43401 ARNHEM**

pendant light; steel, white / paper, seagrass, white, brown  
 Hängeleuchte; Stahl, weiss / Papier, Seegrass, weiss, braun  
 luminaire en suspension; acier, blanc / papier, en jonc de mer, blanc, marron

H 1100, Ø 240



E27 1x 40W



9 002759 434014



**43402 ARNHEM**

pendant light; steel, white / paper, seagrass, white, brown  
 Hängeleuchte; Stahl, weiss / Papier, Seegrass, weiss, braun  
 luminaire en suspension; acier, blanc / papier, en jonc de mer, blanc, marron

L 1020, B 240, H 1100



E27 3x 40W



9 002759 434021



**43403 ARNHEM**

pendant light; steel, white / paper, seagrass, white, brown  
 Hängeleuchte; Stahl, weiss / Papier, Seegrass, weiss, braun  
 luminaire en suspension; acier, blanc / papier, en jonc de mer, blanc, marron

H 1300, Ø 960



E27 3x 40W



9 002759 434038







### 43556 ARNHEM

floor light; steel, white / paper, seagrass, white, brown  
 Stehleuchte; Stahl, weiss / Papier, Seegrass, weiss, braun  
 lampadaire; acier, blanc / papier, en jonc de mer, blanc, marron

H 1510, Ø 440, Base: Ø 750



E27



1x 40W

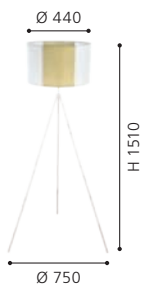

9 002759 435561



### 43393 MEDIUMA

pendant light; steel, beige / glass vaporized, seagrass, gold color, brown

Hängeleuchte; Stahl, beige / Glas bedampft, Seegrass, goldfarben, braun

luminaire en suspension; acier, beige / verre vaporisé, en jonc de mer, doré, marron

H 1100, Ø 230



E27



1x 40W



9 002759 433932



43923





43921



43922



### 43923 KILBURN

spot; wood, brown / steel, white, brown  
 Spot; Holz, braun / Stahl, weiss, braun  
 spot; bois, marron / acier, blanc, marron

L 590, H 170, A 160



E27



3x 40W



9 002759 439231



### 43921 KILBURN

spot; wood, brown / steel, white, brown  
 Spot; Holz, braun / Stahl, weiss, braun  
 spot; bois, marron / acier, blanc, marron

L 120, H 185, A 160



E27



1x 40W



9 002759 439217



### 43922 KILBURN

spot; wood, brown / steel, white, brown  
 Spot; Holz, braun / Stahl, weiss, braun  
 spot; bois, marron / acier, blanc, marron

L 360, H 170, A 160



E27



2x 40W



9 002759 439224





49283



49284



49213

### 49284 BRADFORD

table light; steel, antique silver / glass, clear  
Tischleuchte; Stahl, silber-antik / Glas, klar  
luminaire de table; acier, argent antique / verre, transparent

H 330, Ø 140



E27 1x 60W



9 002759 492847



### 49283 BRADFORD

table light; steel, black / glass, clear  
Tischleuchte; Stahl, schwarz / Glas, klar  
luminaire de table; acier, noir / verre, transparent

H 330, Ø 140



E27 1x 60W



9 002759 492830



### 49213 BRADFORD

pendant light; steel, black / glass, clear  
Hängeleuchte; Stahl, schwarz / Glas, klar  
luminaire en suspension; acier, noir / verre, transparent

H 1100, Ø 140



E27 1x 60W



9 002759 492137

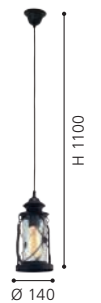



43624



43623

### 43624 BRADFORD 1

table light; steel, black / glass, clear  
Tischleuchte; Stahl, schwarz / Glas, klar  
luminaire de table; acier, noir / verre, transparent

L 150, B 150, H 405



E27



1x 60W



9 002759 436247



### 43623 BRADFORD 1

table light; steel, black / glass, clear  
Tischleuchte; Stahl, schwarz / Glas, klar  
luminaire de table; acier, noir / verre, transparent

L 165, B 150, H 370



E27



1x 60W



9 002759 436230





43642



43653



43652

### 43642 KENSAL

table light; steel, grey, black / fabric, black  
Tischleuchte; Stahl, grau, schwarz / Textil, schwarz  
luminaire de table; acier, gris, noir / tissu, noir

H 435, Ø 250, Base: Ø 140



E27 1x 40W



9 002759 436421



### 43653 NIMLET

table light; steel, black / fabric, black  
Tischleuchte; Stahl, schwarz / Textil, schwarz  
luminaire de table; acier, noir / tissu, noir

H 515, Ø 300, Base: Ø 135



E27 1x 40W



9 002759 436537



### 43652 NIMLET

table light; steel, black / fabric, white  
Tischleuchte; Stahl, schwarz / Textil, weiss  
luminaire de table; acier, noir / tissu, blanc

H 515, Ø 300, Base: Ø 135



E27 1x 40W



9 002759 436520





49724



49489



49851

### 49724 KINROSS

pendant light; steel, brown / wood, brown  
Hängeleuchte; Stahl, braun / Holz, braun  
luminaire en suspension; acier, marron / bois, marron

H 1100, Ø 310



E27 1x 60W



9 002759 497248



### 49489 HAMBLETON

pendant light; steel, satin nickel / steel, white  
Hängeleuchte; Stahl, nickel-matt / Stahl, weiss  
luminaire en suspension; acier, nickel mat / acier, blanc

H 1100, Ø 350



E27 1x 60W



9 002759 494896



### 49851 CAPOSILE

pendant light; steel, white  
Hängeleuchte; Stahl, weiss  
luminaire en suspension; acier, blanc

H 1100, Ø 545

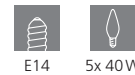

E14 5x 40W



9 002759 498511

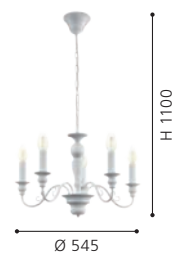





49927

### 49927 TOWNSHEND 2

pendant light; steel, wood, white-patina / fabric, linen, white, brown

Hängeleuchte; Stahl, Holz, weiss-patina / Textil, Leinen, weiss, braun

luminaire en suspension; acier, bois, blanc patiné / tissu, lin, blanc, marron

L 1000, B 150, H 1100



E27



4x 60W



9 002759 499273

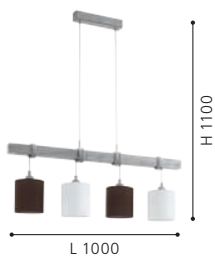



# VINTAGE

## #USED #LOOK

Did you know that the word Vintage originally meant „wine harvest“? Vintage style means a piece of furniture built anew but designed in a „used look“. Genuine vintage pieces from the 1920s to 1980s can be found in flea markets or in the attic, by contrast. Genuine or as imitations: Vintage reminds us of the good old days: summer holidays with the grandparents, the first ride in grandpa’s vintage car and the best apple pie from grandma’s enameled mould. Travel through time, and enjoy feelings of nostalgia with a glass of wine. We recommend accompanying the wine with a taste of our vintage product range.

Wussten Sie, dass das Wort Vintage ursprünglich „Weinlese“ bedeutet? Vom Vintage-Stil spricht man, wenn ein Einrichtungstück neu gebaut, aber im „Used-Look“ designt ist. Echte Vintage-Stücke aus den 20er bis 80er-Jahren findet man hingegen auf Flohmärkten oder am Dachboden. Ob echt oder nachgebaut, Vintage erinnert uns an die gute alte Zeit: Sommerferien bei den Großeltern, die erste Fahrt mit Opas Oldtimer und der beste Apfelkuchen aus Omas Emaille-Form. Erleben Sie eine Zeitreise, schwelgen Sie in Nostalgiegefühlen und schenken Sie sich ein Glas Wein ein. Als Weinbegleitung empfehlen wir ein Reinschnuppern in unsere Vintage-Produktserie.

Est-ce que vous saviez que le mot Vintage voulait originellement dire « vendanges » ? Lorsqu’une pièce de décor est fabriquée à neuf, mais qu’elle est conçue dans le « Used-Look » (look usé), l’on parle de style Vintage. Contrairement, des vraies pièces Vintage, des années 20 jusqu’aux années 80, se trouvent soit sur le marché aux puces, soit au grenier. Qu’elles soient réelles ou imitées, Vintage nous rappelle le bon vieux temps : les vacances d’été chez les grands-parents, la première conduite avec la voiture de collection du grand-père et la meilleure tarte aux pommes du moule en émail de la grand-mère. Découvrez un voyage dans le temps, festoyez dans des sentiments nostalgiques et versez-vous un verre de vin. Nous recommandons, comme accompagnement de vin, un reniflement dans notre série de produit Vintage.



VINOZA  
250



GARGRAVE  
251



GILTSPUR  
252



CHISLE  
253



WOOTTON  
254 - 255



YOUNGSTOWN  
256



FINDLAY  
257



RAMPSIDE  
257 - 259



COTTINGHAM  
260



PADSTOW  
260



TARLE  
261



RODING  
262



STOCKBURY  
263



This product is available in different colors and shapes./ Dieser Artikel ist in unterschiedlichen Farben und Formen verfügbar.  
Cet article est disponible en différentes couleurs et formes.



43824



43823

### 43824 VINOZA

table light; ceramic, white / fabric, black  
Tischleuchte; Keramik, weiss / Textil, schwarz  
luminaire de table; céramique, blanc / tissu, noir

H 535, Ø 300, Base: Ø 120



E27 1x 40W



9 002759 438241



### 43823 VINOZA

table light; ceramic, black / fabric, white  
Tischleuchte; Keramik, schwarz / Textil, weiss  
luminaire de table; céramique, noir / tissu, blanc

H 535, Ø 300, Base: Ø 120



E27 1x 40W



9 002759 438234





43929

### 43929 GARGRAVE

table light; steel, grey, brushed brass / glass vaporized, black-brown-transparent

Tischleuchte; Stahl, grau, messing-gebürstet / Glas bedampft, schwarz-braun-transparent

luminaire de table; acier, gris, laiton brossé / verre vaporisé, noir-marron-transparent

H 315, Ø 110, Base: Ø 150



E27



1x 40W



9 002759 439293



DESIGN  
HIGHLIGHT  
DETAIL



### DETAIL GARGRAVE

The rotary switch can be used to switch the lamp on and off.

Der Drehschalter kann zum ein- und ausschalten der Leuchte verwendet werden.

L'interrupteur rotatif peut être utilisé pour allumer et éteindre le luminaire.



43554



43553

### 43554 GILTSPUR

pendant light; steel, black  
Hängeleuchte; Stahl, schwarz  
luminaire en suspension; acier, noir

L 770, B 180, H 1100



E27



3x 40W



9 002759 435547



### 43553 GILTSPUR

ceiling light; steel, black  
Deckenleuchte; Stahl, schwarz  
plafonnier; acier, noir

H 230, Ø 550



E27



3x 40W



9 002759 435530





43527



43499



43528



### DETAIL CHISLE

The mixture of steel and vaporized glass gives these luminaires a unique look.

Die Mischung aus Stahl und bedampftem Glas verleiht diesen Leuchten eine besondere Optik. Le mélange d'acier et de verre vaporisé donne à ces luminaires un look unique.

### 43527 CHISLE

pendant light; steel, black, bronzed / glass vaporized, amber

Hängeleuchte; Stahl, schwarz, brüniert / Glas bedampft, amber

luminaire en suspension; acier, noir, brun / verre vaporisé, ambre

H 1100, Ø 165



E27



1x 40W



9 002759 435271



Ø 165

### 43499 CHISLE

pendant light; steel, black, bronzed / glass vaporized, amber

Hängeleuchte; Stahl, schwarz, brüniert / Glas bedampft, amber

luminaire en suspension; acier, noir, brun / verre vaporisé, ambre

H 1300, Ø 425



E27



3x 40W



9 002759 434991



Ø 425

### 43528 CHISLE

pendant light; steel, black, bronzed / glass vaporized, amber

Hängeleuchte; Stahl, schwarz, brüniert / Glas bedampft, amber

luminaire en suspension; acier, noir, brun / verre vaporisé, ambre

L 1300, B 165, H 1100



E27



4x 40W



9 002759 435288

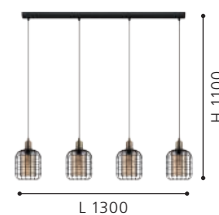

L 1300

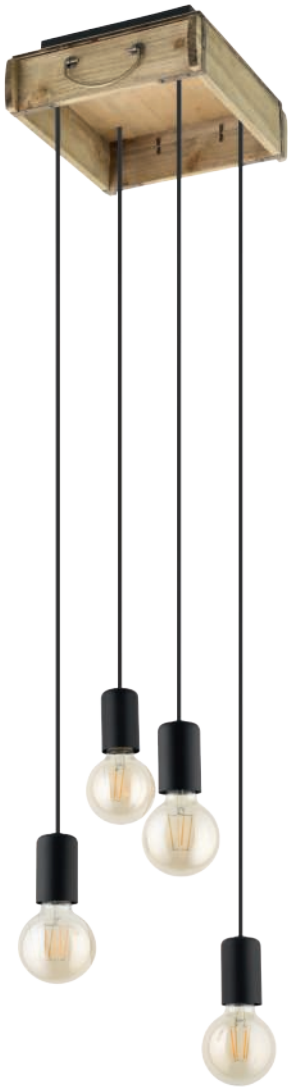

43591



43593



43592

### 43591 WOOTTON

pendant light; wood, steel, brown, black  
 Hängeleuchte; Holz, Stahl, braun, schwarz  
 luminaire en suspension; bois, acier, marron, noir

L 250, B 280, H 1100



E27 4x 40W



9 002759 435912



### 43593 WOOTTON

wall light; wood, steel, brown, black  
 Wandleuchte; Holz, Stahl, braun, schwarz  
 Applique; bois, acier, marron, noir

L 145, H 270, A 115



E27 1x 40W



9 002759 435936



### 43592 WOOTTON

pendant light; wood, steel, brown, black  
 Hängeleuchte; Holz, Stahl, braun, schwarz  
 luminaire en suspension; bois, acier, marron, noir

L 810, B 220, H 1100



E27 6x 40W



9 002759 435929







43594

### 43594 WOOTTON

table light; wood, steel, brown, black  
Tischleuchte; Holz, Stahl, braun, schwarz  
luminaire de table; bois, acier, marron, noir

L 250, B 220, H 375



E27



3x 40W



9 002759 435943



DESIGN  
HIGHLIGHT  
DETAIL



43318



43319

### 43318 YOUNGSTOWN

pendant light; steel, wood, black, brown  
 Hängeleuchte; Stahl, Holz, schwarz, braun  
 luminaire en suspension; acier, bois, noir, marron

L 700, B 45, H 1100



E27 4x 40W



9 002759 433185



### 43319 YOUNGSTOWN

pendant light; steel, wood, black, brown  
 Hängeleuchte; Stahl, Holz, schwarz, braun  
 luminaire en suspension; acier, bois, noir, marron

L 1000, B 45, H 1100

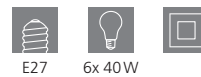

E27 6x 40W



9 002759 433192

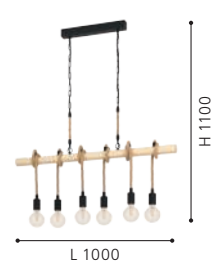



49694



43194

### 49694 FINDLAY

pendant light; steel, black  
Hängeleuchte; Stahl, schwarz  
luminaire en suspension; acier, noir

H 1500, Ø 560



E27



6x 60W



9 002759 496944

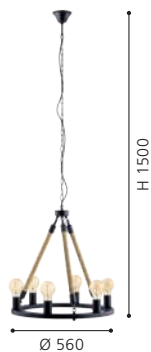

H 1500

Ø 560

### 43194 RAMPSIDE

pendant light; steel, black  
Hängeleuchte; Stahl, schwarz  
luminaire en suspension; acier, noir

H 1090, Ø 760



E27



6x 28W



9 002759 431945



H 1090

Ø 760



43192



43195

#### DETAIL 43195

The luminaire heads can be installed on the ceiling individually.  
Die Leuchtenköpfe können individuell an die Decke montiert werden.  
Les têtes de luminaires peuvent être montées individuellement au plafond.



#### 43192 RAMPSIDE

pendant light; steel, black / glass vaporized, amber  
Hängeleuchte; Stahl, schwarz / Glas bedampft, amber  
luminaire en suspension; acier, noir / verre vaporisé, ambre

L 895, B 195, H 1230



E27 3x 28W



9 002759 431921



#### 43195 RAMPSIDE

pendant light; steel, black  
Hängeleuchte; Stahl, schwarz  
luminaire en suspension; acier, noir

H 1590, Ø 180



E27 6x 28W



9 002759 431952



#### 43197 RAMPSIDE

wall light; steel, wood, black, brown  
Wandleuchte; Stahl, Holz, schwarz, braun  
Applique; acier, bois, noir, marron

L 80, H 300, A 135



E27 1x 28W



9 002759 431976





43197



43256

### 43256 RAMPSIDE

pendant light; steel, black  
Hängeleuchte; Stahl, schwarz  
luminaire en suspension; acier, noir

H 1380, Ø 110



E27



1x 28W



9 002759 432560





43328

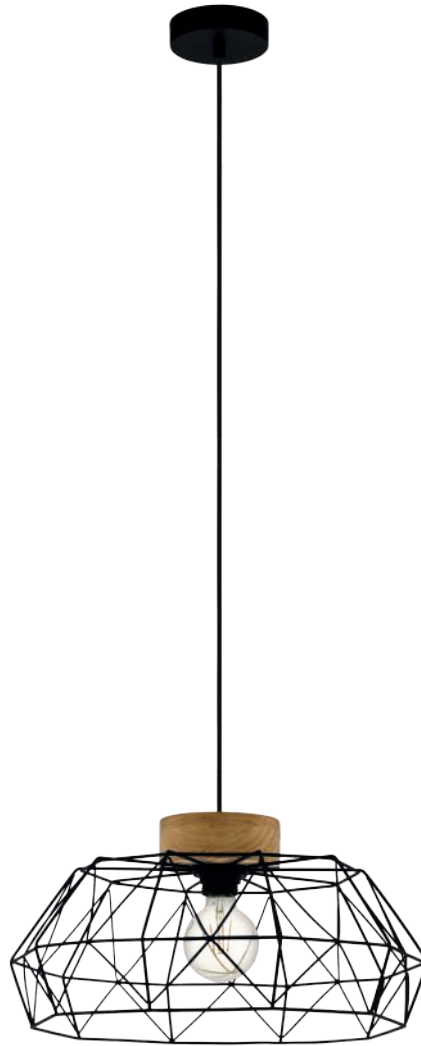

43364



43363

### 43328 COTTINGHAM

pendant light; steel, black  
Hängeleuchte; Stahl, schwarz  
luminaire en suspension; acier, noir

H 1100, Ø 370



E27 1x 40W



9 002759 433284

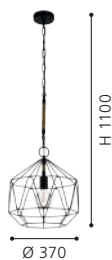

### 43364 PADSTOW

pendant light; steel, wood, black, natural  
Hängeleuchte; Stahl, Holz, schwarz, natur  
luminaire en suspension; acier, bois, noir, naturel

H 1100, Ø 455



E27 1x 60W



9 002759 433642



### 43363 PADSTOW

ceiling light; steel, wood, black, natural  
Deckenleuchte; Stahl, Holz, schwarz, natur  
plafonnier; acier, bois, noir, naturel

H 205, Ø 455



E27 1x 60W



9 002759 433635





43845

### 43845 TARLE

pendant light; steel, black  
Hängeleuchte; Stahl, schwarz  
luminaire en suspension; acier, noir

H 1100, Ø 445



E14



3x 40W



9 002759 438456

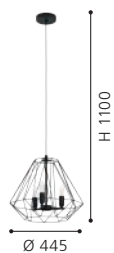



43619



43617



43618

### 43619 RODING

wall light; steel, wood, black, brown / glass, clear  
Wandleuchte; Stahl, Holz, schwarz, braun / Glas, klar  
Applique; acier, bois, noir, marron / verre, transparent

L 180, H 350, A 180



E27



1x 40W



9 002759 436193



L 180

H 350

A 180

### 43617 RODING

pendant light; steel, wood, black, brown / glass, clear  
Hängeleuchte; Stahl, Holz, schwarz, braun / Glas, klar  
luminaire en suspension; acier, bois, noir, marron / verre, transparent

H 1100, Ø 180



E27



1x 40W



9 002759 436179



H 1100

Ø 180

### 43618 RODING

pendant light; steel, wood, black, brown / glass, clear  
Hängeleuchte; Stahl, Holz, schwarz, braun / Glas, klar  
luminaire en suspension; acier, bois, noir, marron / verre, transparent

L 880, B 180, H 1100



E27



3x 40W



9 002759 436186



H 1100

L 880





49458



49456



49457

### 49458 STOCKBURY

wall light; steel, antique-brown, beige  
Wandleuchte; Stahl, antik-braun, beige  
Applique; acier, marron antique, beige

L 210, H 225, A 270



E27



1x 60W



9 002759 494582



L 210

H 225

A 270

### 49456 STOCKBURY

pendant light; steel, antique-brown, beige  
Hängeleuchte; Stahl, antik-braun, beige  
luminaire en suspension; acier, marron antique, beige

H 1100, Ø 360



E27



1x 60W



9 002759 494568



H 1100

Ø 360

### 49457 STOCKBURY

pendant light; steel, antique-brown, beige  
Hängeleuchte; Stahl, antik-braun, beige  
luminaire en suspension; acier, marron antique, beige

L 800, B 300, H 1100



E27



2x 60W



9 002759 494575

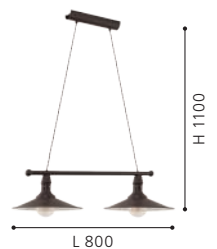

H 1100

L 800

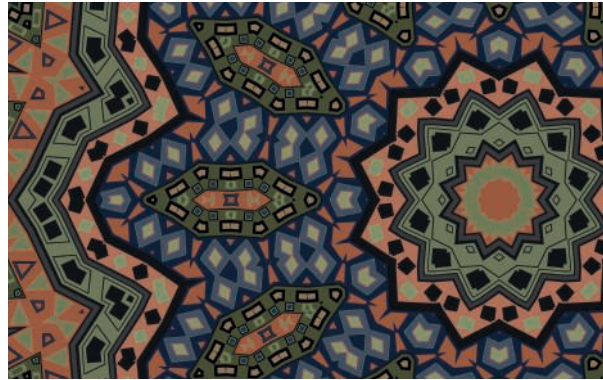

# ETHNO ELEGANCE

#EXOTIC  
#ORIENT

A little Orient, a bit of Africa, a touch of Latin America – but nothing common at all! These lamps let you dive into a world of exotic markets with spices, colours and shapes. Bring fairy-tale moments from remote countries to your home – with Ethno Elegance.

Ein bisschen Orient, ein wenig Afrika, ein Hauch Lateinamerika – nur nichts Gewöhnliches! Mit diesen Leuchten tauchen Sie ein in eine Welt exotischer Märkte mit Gewürzen, Farben und Formen. Holen Sie märchenhafte Momente aus fernen Ländern zu sich nach Hause – mit Ethno Elegance.

Un peu oriental, un peu africain, une touche d'Amérique latine – surtout rien d'ordinaire ! Grâce à ces luminaires, vous entrez dans un monde de marchés exotiques avec des épices, des couleurs et des formes. Apportez des moments féeriques dans votre maison, venant de pays lointains – grâce à Ethno Elegance.



GRIZEDALE  
266



FELIXKIRK  
266



MUMBLES  
269



SANDBACH  
270



SAFI  
272



CARDIGAN  
272



JADIDA  
274



SUDBURY  
275



TALBOT 2  
275



TAMALLAT  
276



STAVERTON  
277



BRIDEKIRK  
277



This product is available in different colors and shapes./ Dieser Artikel ist in unterschiedlichen Farben und Formen verfügbar.  
Cet article est disponible en différentes couleurs et formes.

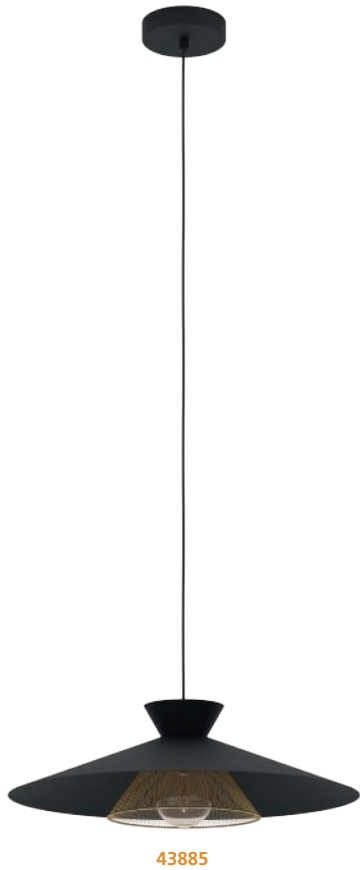

43885

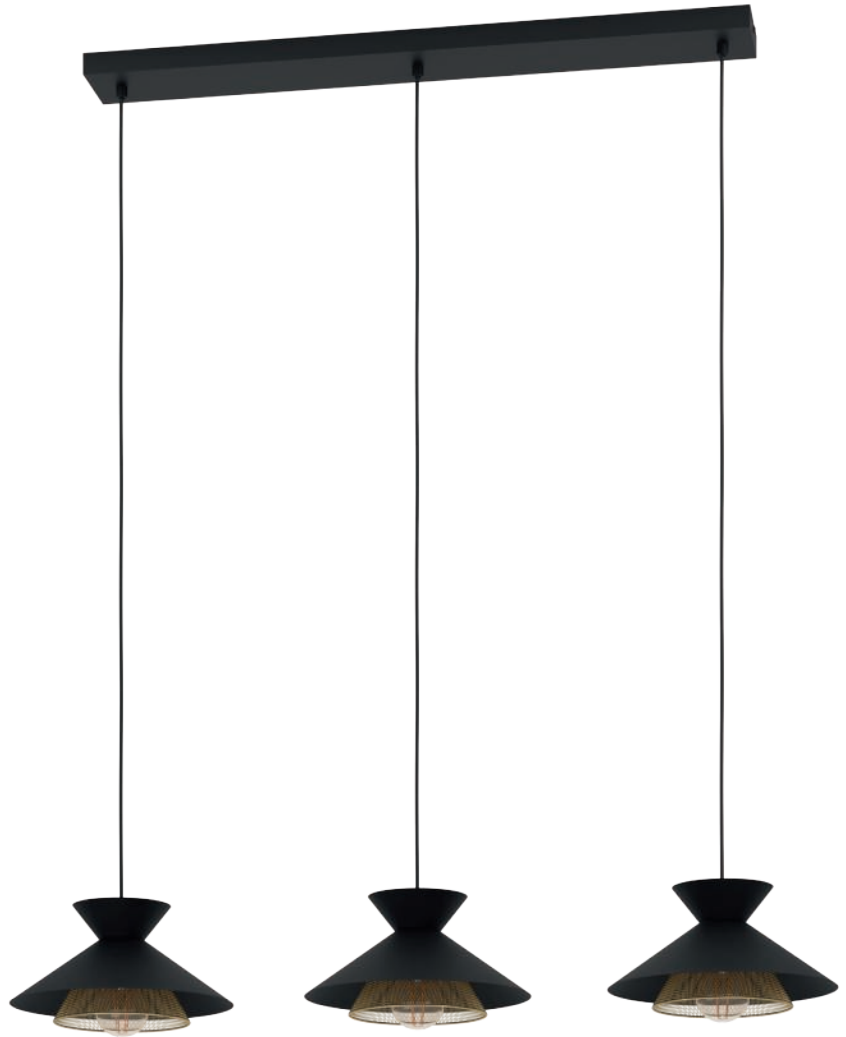

43886

### 43885 GRIZEDALE

pendant light; steel, black, brass  
 Hängeleuchte; Stahl, schwarz, messing  
 luminaire en suspension; acier, noir, laiton

H 1100, Ø 500



E27 1x 40W



9 002759 438852

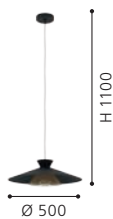

### 43886 GRIZEDALE

pendant light; steel, black, brass  
 Hängeleuchte; Stahl, schwarz, messing  
 luminaire en suspension; acier, noir, laiton

L 960, B 260, H 1100



E27 3x 40W



9 002759 438869

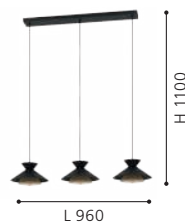

### 43931 FELIXKIRK

pendant light; steel, black / steel, black, gold  
 Hängeleuchte; Stahl, schwarz / Stahl, schwarz, gold  
 luminaire en suspension; acier, noir / acier, noir, or

H 1100, Ø 570



E27 1x 40W



9 002759 439316





43931





43813

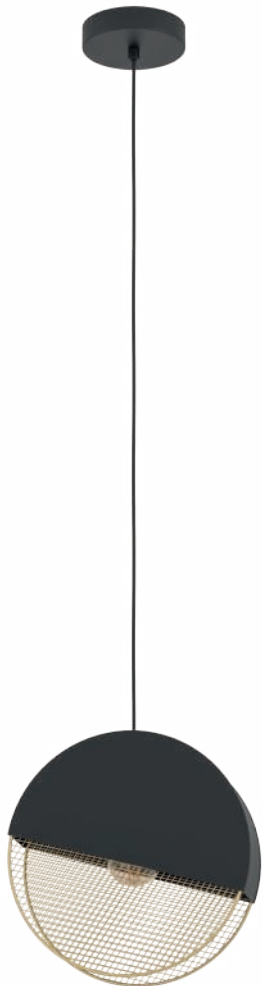

43811



43812

### 43813 MUMBLES

table light; steel, black, gold  
Tischleuchte; Stahl, schwarz, gold  
luminaire de table; acier, noir, or

L 280, B 90, H 285, Base: Ø 170



E27 1x 40W



9 002759 438135

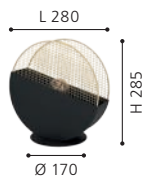

### 43811 MUMBLES

pendant light; steel, black, gold  
Hängeleuchte; Stahl, schwarz, gold  
luminaire en suspension; acier, noir, or

L 285, B 90, H 1100



E27 1x 40W



9 002759 438111



### 43812 MUMBLES

pendant light; steel, black, gold  
Hängeleuchte; Stahl, schwarz, gold  
luminaire en suspension; acier, noir, or

L 860, B 90, H 1100



E27 2x 40W



9 002759 438128

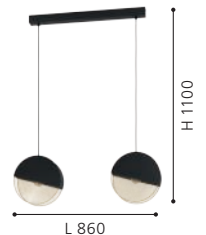



43979



43982

### 43979 SANDBACH

ceiling light; steel, black, brass  
Deckenleuchte; Stahl, schwarz, messing  
plafonnier; acier, noir, laiton

H 220, Ø 420



E27 1x 40W



9 002759 439798



### 43982 SANDBACH

table light; steel, black, brass  
Tischleuchte; Stahl, schwarz, messing  
luminaire de table; acier, noir, laiton

H 450, Ø 240, Base: Ø 200



E27 1x 40W



9 002759 439828



### 43981 SANDBACH

pendant light; steel, black, brass  
Hängeleuchte; Stahl, schwarz, messing  
luminaire en suspension; acier, noir, laiton

H 1100, Ø 420



E27 1x 40W



9 002759 439811







43981





49871



DESIGN  
HIGHLIGHT  
DETAIL

### 49871 SAFI

pendant light; steel, brown, gold  
Hängeleuchte; Stahl, braun, gold  
luminaire en suspension; acier, marron, or

L 700, B 160, H 1100



E27



3x 60W



9 002759 498719



### 49274 CARDIGAN

table light; steel, brown-patina / glass, clear  
Tischleuchte; Stahl, braun-patina / Glas, klar  
luminaire de table; acier, marron patiné / verre, transparent

H 265, Ø 120



E27



1x 60W



9 002759 492748

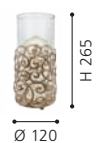



49274



49764



49765

### 49764 JADIDA

pendant light; steel, antique copper coloured / glass, coloured  
 Hängeleuchte; Stahl, kupferfarben-antik / Glas, bunt  
 luminaire en suspension; acier, cuivré antique / verre, coloré

H 1100, Ø 330



E27



1x 60W



9 002759 497644



### 49765 JADIDA

pendant light; steel, antique copper coloured / glass, coloured  
 Hängeleuchte; Stahl, kupferfarben-antik / Glas, bunt  
 luminaire en suspension; acier, cuivré antique / verre, coloré

H 1100, Ø 220



E27



1x 60W



9 002759 497651





49221

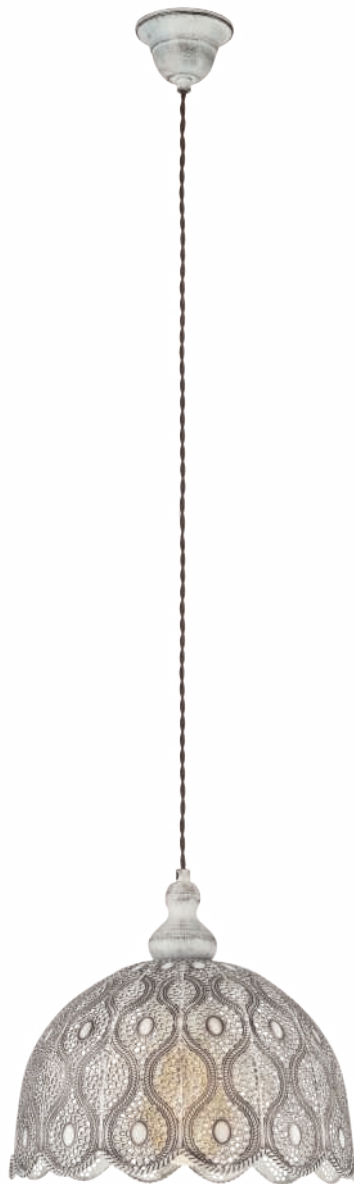

49717

### 49221 SUDBURY

pendant light; steel, white-patina / glass, clear  
Hängeleuchte; Stahl, weiss-patina / Glas, klar  
luminaire en suspension; acier, blanc patiné / verre, transparent

H 1100, Ø 170



E27



1x 60W



9 002759 492212

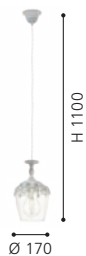

### 49717 TALBOT 2

pendant light; steel, antique white  
Hängeleuchte; Stahl, weiss-antik  
luminaire en suspension; acier, blanc antique

H 1100, Ø 295



E27



1x 60W



9 002759 497170

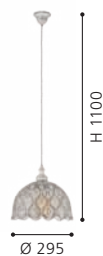

DESIGN  
HIGHLIGHT  
DETAIL



43576



43577

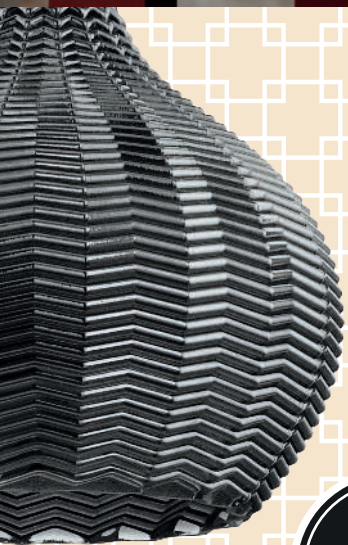

DESIGN  
HIGHLIGHT  
DETAIL

### 43576 TAMALLAT

pendant light; steel, black / glass vaporized, black-transparent  
Hängeleuchte; Stahl, schwarz / Glas bedampft, schwarz-transparent  
luminaire en suspension; acier, noir / verre vaporisé, noir transparent

H 1100, Ø 230



E27 1x 40W



9 002759 435769



### 43577 TAMALLAT

pendant light; steel, black / glass vaporized, black-transparent  
Hängeleuchte; Stahl, schwarz / Glas bedampft, schwarz-transparent  
luminaire en suspension; acier, noir / verre vaporisé, noir transparent

L 1050, B 230, H 1100



E27 3x 40W



9 002759 435776

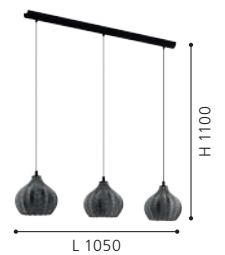

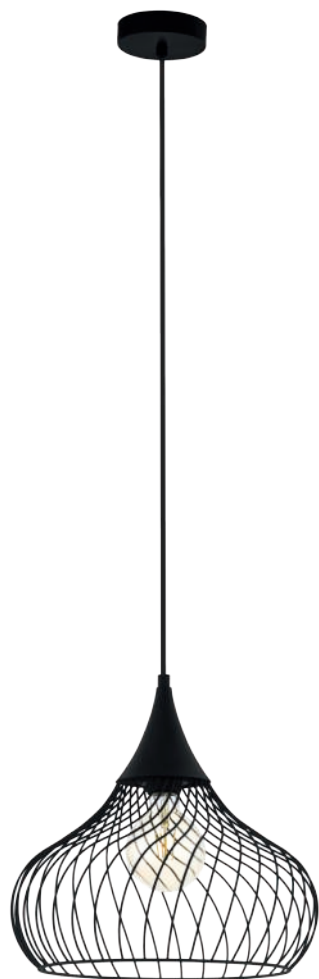

43344



43292

### 43344 STAVERTON

pendant light; steel, black  
Hängeleuchte; Stahl, schwarz  
luminaire en suspension; acier, noir

H 1100, Ø 365



E27



1x 60W



9 002759 433444

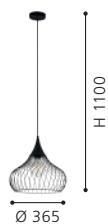

### 43292 BRIDEKIRK

pendant light; steel, black / fabric, linen, natural  
Hängeleuchte; Stahl, schwarz / Textil, Leinen, natur  
luminaire en suspension; acier, noir / tissu, lin, nature

H 1100, Ø 400



E27



1x 40W



9 002759 432928



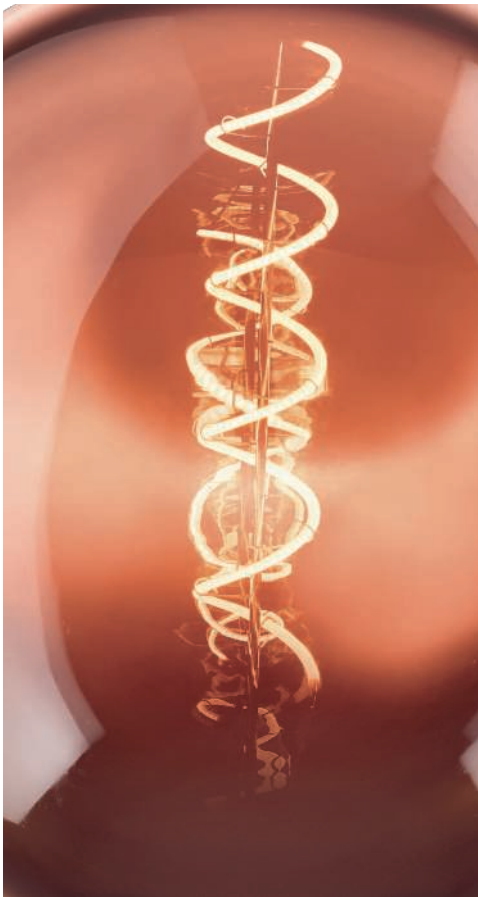

# SOCKETS & ILLUMINANTS

#BRIGHT  
#LIGHT

Minimalism at its best! The SOCKET series by EGLO comes in a variety of styles: from a discreet brass ring attachment to a gritty industrial finish. The most important thing is to choose the best light source to skilfully present the luminaire in its best light.

Minimalismus pur! So präsentiert sich die SOCKET-Serie von EGLO in verschiedenen Stilen: Ob mit dezentem Messingring oder grober Industrial-Haptik. Wichtig bleibt dabei die Wahl des richtigen Leuchtmittels, um die Fassung gekonnt in Szene zu setzen.

Le minimalisme à l'état pur ! Voici comment se présente la série SOCKET d'EGLO dans différents styles : avec un discret anneau en laiton ou une structure rugueuse à l'esprit industriel. L'essentiel est de bien choisir l'ampoule afin de mettre habilement la douille en valeur.



<b>CRANLEY</b> 280 	<b>YORTH</b> 281 - 282 	<b>CALARI</b> 282 	<b>110095</b> 284 	<b>110096</b> 285 	<b>110097</b> 285 	<b>110098</b> 286 	<b>110099</b> 286 	
<b>110101</b> 287 	<b>110102</b> 288 	<b>110103</b> 288 	<b>110104</b> 289 	<b>110105</b> 289 	<b>110106</b> 290 	<b>110107</b> 290 	<b>110108</b> 291 	
<b>110109</b> 292 	<b>110111</b> 292 	<b>110112</b> 293 	<b>110117</b> 294 	<b>110118</b> 295 	<b>110119</b> 295 	<b>110113</b> 296 	<b>110114</b> 296 	
<b>110115</b> 297 	<b>110116</b> 297 							

 This product is available in different colors and shapes./ Dieser Artikel ist in unterschiedlichen Farben und Formen verfügbar.  
 Cet article est disponible en différentes couleurs et formes.



43758



DESIGN  
HIGHLIGHT  
DETAIL

### 43758 CRANLEY

floor light; steel, black  
Stehleuchte; Stahl, schwarz  
lampadaire; acier, noir

L 430, B 60, H 1700, Base: Ø 300



E27



1x 40W



9 002759 437589

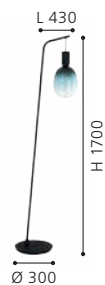



43803



43802



43801



DESIGN  
HIGHLIGHT  
DETAIL

### 43803 YORTH

pendant light; steel, black, bronzed  
Hängeleuchte; Stahl, schwarz, brüniert  
luminaire en suspension; acier, noir, brun

H 1500, Ø 50



E27 1x 40W



9 002759 438036



Ø 50

### 43802 YORTH

pendant light; steel, black, silver  
Hängeleuchte; Stahl, schwarz, silber  
luminaire en suspension; acier, noir, argent

H 1500, Ø 50



E27 1x 40W



9 002759 438029



Ø 50

### 43801 YORTH

pendant light; steel, nickel-nero, black  
Hängeleuchte; Stahl, nickel-nero, schwarz  
luminaire en suspension; acier, nickel brillant, noir

H 1500, Ø 50



E27 1x 40W



9 002759 438012



Ø 50



32539

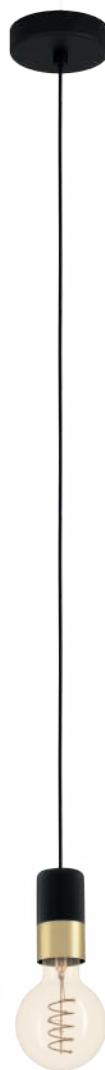

31075

### 32539 YORTH

pendant light; steel, brushed copper  
Hängeleuchte; Stahl, kupfer-gebürstet  
luminaire en suspension; acier, cuivre brossé

H 2000, Ø 100



E27 1x 60W



9 002759 325398

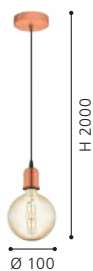

### 31075 CALARI

pendant light; steel, black, brass  
Hängeleuchte; Stahl, schwarz, messing  
luminaire en suspension; acier, noir, laiton

H 1500, Ø 45



E27 1x 40W



9 002759 310752



### 31073 CALARI

pendant light; steel, black  
Hängeleuchte; Stahl, schwarz  
luminaire en suspension; acier, noir

L 95, B 65, H 1500



E27 1x 40W



9 002759 310738





31073













# BIG SIZE

- › Extra large shape, modern colors and surfaces
- › Straight and spiral filaments
- › The eye-catcher in your living area
- › Energy-saving LED filament technology
- › Extra große Form, moderne Farben und Oberflächen
- › Gerade und spiralförmige Filamente
- › Der Blickfang in Ihrem Wohnbereich
- › Energiesparende LED Filamenttechnologie
- › Forme extra large, couleurs et surfaces modernes
- › Filaments droits et spiralés
- › Attire l'attention dans votre salon
- › Technologie de filament LED à économie d'énergie













## 110095 E27-LED-G200

 <b>50 lm</b>	<b>warm WHITE</b>	<b>2200 K</b>	
 L 255, Ø 200	 80 CRI		
 4 W			
 220-240V, 50/60Hz			
 E27			
 dimmable			
 15000 h			

9 008606 228256













## 110096 E27-LED-G200

 <b>40 lm</b>	<b>warm WHITE</b>	<b>1900 K</b>	
 L 255, Ø 200	 80 CRI		
 4 W			
 220-240V, 50/60Hz			
 E27			
 dimmable			
 15000 h	 9 008606 228263		



## 110097 E27-LED-G200

 <b>40 lm</b>	<b>warm WHITE</b>	<b>1600 K</b>	
 L 255, Ø 200	 80 CRI		
 4 W			
 220-240V, 50/60Hz			
 E27			
 dimmable			
 15000 h	 9 008606 228270		



## 110098 E27-LED-APPLE



50 lm

warm  
WHITE

2200 K



L 220, Ø 220



80 CRI



4 W



220-240V, 50/60Hz



E27



dimmable



15000 h



9 008606 228287



## 110099 E27-LED-APPLE



40 lm

warm  
WHITE

1900 K



L 220, Ø 220



80 CRI



4 W



220-240V, 50/60Hz



E27



dimmable



15000 h



9 008606 228294



**110101** E27-LED-APPLE

40 lm

warm  
WHITE

1600 K



L 220, Ø 220



80 CRI



4 W



220-240V, 50/60Hz



E27



dimmable



15000 h



9 008606 228300





## 110102 E27-LED-G200



470 lm



2700 K



L 255, Ø 200



4.5 W ~ 40 W



4.5 W



80 CRI



220-240V, 50/60Hz



E27



dimmable



25000 h



## 110103 E27-LED-E170



470 lm



2700 K



L 270, Ø 170



4.5 W ~ 40 W



4.5 W



80 CRI



220-240V, 50/60Hz



E27



dimmable













25000 h















## 110104 E27-LED-TS140

 <b>470 lm</b>	<b>warm WHITE</b>	<b>2700 K</b>	
 L 200, Ø 140	 4.5 W ~ 40 W		
 4.5 W	 80 CRI		
 220-240V, 50/60Hz			
 E27			
 dimmable			
 25000 h	 9 008606 228331		



## 110105 E27-LED-R140

 <b>470 lm</b>	<b>warm WHITE</b>	<b>2700 K</b>	
 L 190, Ø 140	 4.5 W ~ 40 W		
 4.5 W	 80 CRI		
 220-240V, 50/60Hz			
 E27			
 dimmable			
 25000 h	 9 008606 228348		



### 110106 E27-LED-E140

<b>470 lm</b>	<b>warm WHITE</b>	<b>2200 K</b>	
L 340, Ø 140	4.5 W ~ 40 W		
4.5 W	80 CRI		
220-240V, 50/60Hz			
E27			
dimmable			
15000 h			
			9 008606 228355











### 110107 E27-LED-PS160

<b>470 lm</b>	<b>warm WHITE</b>	<b>2200 K</b>	
L 320, Ø 160	4.5 W ~ 40 W		
4.5 W	80 CRI		
220-240V, 50/60Hz			
E27			
dimmable			
15000 h			
			9 008606 228362

### 110108 E27-LED-G200



 **470 lm**    **warm WHITE**    **2200 K**    

 L 305, Ø 200	 4.5 W ~ 40 W
 4.5 W	 80 CRI
 220-240V, 50/60Hz	
 E27	
 dimmable	
 15000 h	 9 008606 228379





### 110109 E27-LED-E140

<b>806 lm</b>	<b>warm WHITE</b>	<b>2100 K</b>	
L 340, Ø 140	8 W ~ 60 W		
8 W	80 CRI		
220-240V, 50/60Hz			
E27			
dimmable			
15000 h			9 008606 228386

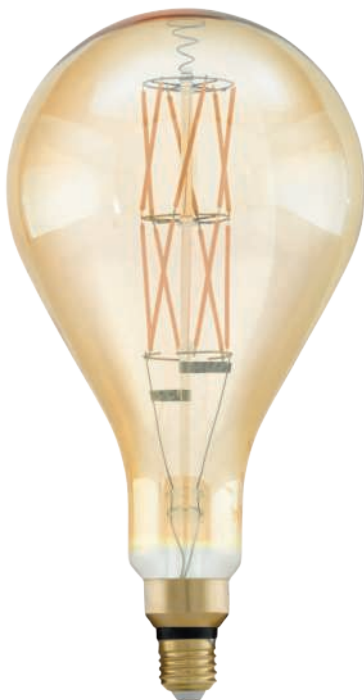









### 110111 E27-LED-PS160

<b>806 lm</b>	<b>warm WHITE</b>	<b>2100 K</b>	
L 320, Ø 160	8 W ~ 60 W		
8 W	80 CRI		
220-240V, 50/60Hz			
E27			
dimmable			
15000 h			9 008606 228393



### 110112 E27-LED-G200

 **806 lm**    **warm WHITE**    **2100 K**    

 L 305, Ø 200	 8 W ~ 60 W
 8 W	 80 CRI
 220-240V, 50/60Hz	
 E27	
 dimmable	
 15000 h	 9 008606 228409

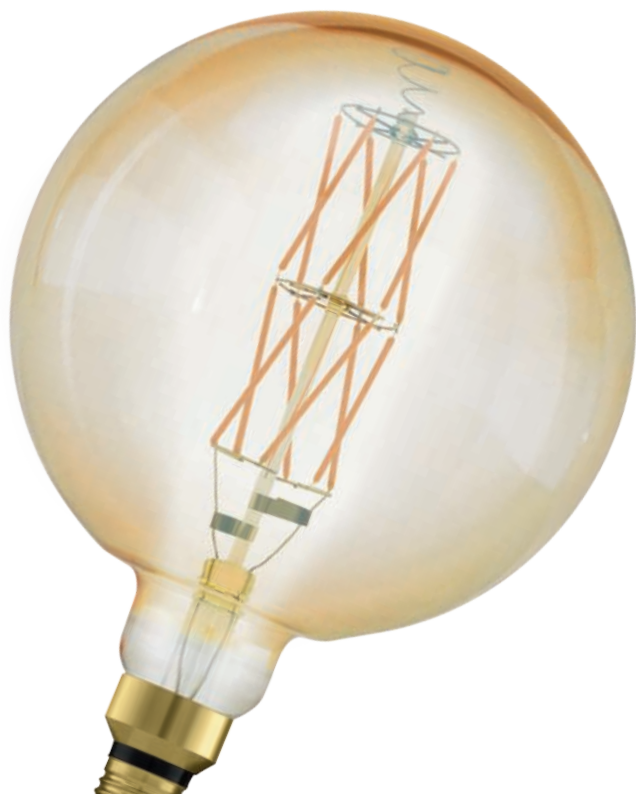













# MID SIZE

- › An eye-catcher in your living area
- › Excellent room lighting
- › Dimmable
- › Der Blickfang in Ihrem Wohnbereich
- › Sehr gute Raumbelichtung
- › Dimmbar
- › L'attrape œil dans votre espace d'habitat
- › Très bon éclairage de la pièce
- › Réglable















## 110117 E27-LED-G150

 <b>200 lm</b>	<b>warm WHITE</b>	<b>2200 K</b>	
 L 200, Ø 150	 2.5 W ~ 20 W		
 2.5 W	 81 CRI		
 220-240V, 50/60Hz			
 E27			
 dimmable			
 15000 h			
 9 008606 228454			

















## 110118 E27-LED-G95

 <b>200 lm</b>	<b>warm WHITE</b>	<b>2200 K</b>	
 L 139, Ø 93	 4		
 2.5 W	 2.5 W ~ 20 W		
 220-240V, 50/60Hz	 81 CRI		
 E27			
 dimmable			
 15000 h	 9 008606 228461		



## 110119 E27-LED

 <b>200 lm</b>	<b>warm WHITE</b>	<b>2200 K</b>	
 L 167, Ø 95	 4		
 2.5 W	 2.5 W ~ 20 W		
 220-240V, 50/60Hz	 81 CRI		
 E27			
 dimmable			
 15000 h	 9 008606 228478		



## 110113 E27-LED-B80



470 lm

warm  
WHITE

2200 K



L 170, Ø 80



4



4.5 W



4.5 W ~ 40 W



220-240V, 50/60Hz



80 CRI



E27



dimmable



15000 h



## 110114 E27-LED-BR150



470 lm

warm  
WHITE

2200 K



L 155, Ø 150



4.5 W ~ 40 W



4.5 W



80 CRI



220-240V, 50/60Hz



E27



dimmable













15000 h















## 110115 E27-LED-T125

 <b>470 lm</b>	<b>warm WHITE</b>	<b>2200 K</b>	
 L 175, Ø 125	 4.5 W ~ 40 W		
 4.5 W	 80 CRI		
 220-240V, 50/60Hz			
 E27			
 dimmable			
 15000 h	 9 008606 228430		



## 110116 E27-LED-R140

 <b>470 lm</b>	<b>warm WHITE</b>	<b>2200 K</b>	
 L 150, Ø 140	 4.5 W ~ 40 W		
 4.5 W	 80 CRI		
 220-240V, 50/60Hz			
 E27			
 dimmable			
 15000 h	 9 008606 228447		

# EGLO WORLDWIDE

EGLO WELTWEIT / EGLO DANS LE MONDE



 **AUSTRIA**  
EGLO LEUCHTEN GMBH

Heiligkreuz 22  
6136 Pill  
T: +43 5242 6996 0 | F: +43 5242 6996 972  
info-austria@eglo.com

 **CHILE**  
EGLO CHILE ILUMINACIÓN LTDA.

Av. Américo Vespucio Norte 1930  
Conchalí - Santiago de Chile  
T: +562 2 595 2222  
info-chile@eglo.com

 **DENMARK**  
EGLO DANMARK A/S

Agerbakken 20  
8362 Hørning  
T: +45 70 22 55 11 | F: +45 70 22 55 221  
info-denmark@eglo.com

 **AUSTRALIA**  
EGLO LIGHTING AUSTRALIA

5/339 Archerfield Road  
4077 Richlands | Queensland  
T: +61 7 3375 1413 | F: +61 7 3375 1412  
info@eglolighting.com.au

 **CHINA**  
DONGGUAN EGLO LIGHTING COMMERCIAL  
CO LTD

No.1 | Shangqiao Industrial Rd Shangqiao, Dongcheng  
Dongguancity, Guanzhouprovince  
T: +86 769 2203 3866 | F: +86 769 2203 6866  
info-china@eglo.com

 **ESTONIA**  
MOODNE VALGUSTUS AS

Rävalapst. 7  
10143 Tallinn  
T: +372 667 6670 | F: +372 631 3195  
info-global@eglo.com

 **BELGIUM**  
EGLO BELGIUM BV

Antwerpsesteenweg 247  
2950 Kapellen  
T: +32 3 250 60 80 | F: +32 3 219 80 67  
info-belgium@eglo.com

 **COLOMBIA**  
EGLO COLOMBIA ILUMINACIÓN SAS

Autopista Norte 800 Mts adelante del Peaje de los Andes  
Costado Oriental Km 19 Lote 30  
Bogotá - Chia  
T: +57 (1) 744 2339  
info-global@eglo.com

 **FINLAND**  
EGLO FINLAND OY

Malmiraitti 17A  
700 Helsinki  
T: +358 20 7649 820 | F: +358 20 7649 821  
info-finland@eglo.com

 **BOSNIA AND HERZEGOVINA**  
EGLO RASVJETA BH D.O.O.

Ormanica bb  
76250 Gradacac  
T: +387 35 86 85 00 | F: +387 35 82 44 41  
info-Bosnia-Herzegovina@eglo.com

 **COSTA RICA**  
EGLO COSTA RICA

Centro Comercial Calle Real local #8  
Guachipilín de Escazú de la sucursal del BAC  
San Jose 800 metros al norte | San Jose  
T: +506-2289-4690 | F: +506-2100-6384  
info-costarica@eglo.com

 **FRANCE**  
EGLO FRANCE LUMINAIRE SARL

Z.A. Jeune Bois | 2 Rue de la Martinique  
68274 Wittenheim  
T: +33 3 89 62 50 45 | F: +33 389 6250 49  
info-france@eglo.com

 **BULGARIA**  
EGLO BULGARIA EOOD

Main Road Burgas-Sofia | 5th kilometer | Building EGLO  
8000 Burgas  
T: +359 56 960 403 | F: +359 56 53 05 95  
info-bulgaria@eglo.com

 **CROATIA**  
EGLO RASVJETA D.O.O.

Jadranska avenija 9a  
10000 Zagreb  
T: +385 1 379 40 62 | F: +385 1 379 41 04  
info-croatia@eglo.com

 **GERMANY**  
EGLO LEUCHTEN HANDELS GMBH

Kleinbahnstr. 35  
59759 Arnsberg  
T: +49 2932 6269 0 | F: +49 2932 6269 39  
info-germany@eglo.com

 **CANADA**  
EGLO CANADA INC.

20700 Route Transcanadienne  
H9X 4B7 Baie D'Ufré, Quebec  
T: +1 514 457 5483 | F: +1 514 457 5487  
info-canada@eglo.com

 **CZECH REPUBLIC**  
EGLO CZ+SK s.r.o.

Náchodská 2479/63  
193 00 Praha 9 Horní Pocernice  
T: +420 281 924 163 | F: +420 281 925 205  
info-czechrepublic@eglo.com

 **GREAT BRITAIN AND IRELAND**  
EGLO UK LTD.

Unit 12 Cirrus Park, Lower Farm Road, Moulton Park  
Industrial Estate, Northampton NN3 6UR  
T: +44 1604 790 986 | F: +44 1604 670 282  
info-greatbritain@eglo.com

**GREECE**

EGLO HELLAS A.E.

Sykias 2 and parodos dekeleias  
13679 Acharnai  
T: +30 21 0800 2363 | F: +30 210 240 07 29  
info-greece@eglo.com

**HUNGARY - PRODUCTION AND LOGISTICS**

EGLO MAGYARORSZAG KFT.

Fő út. 155  
3060 Paszto  
T: + 36 32 560 050 | F: +36 32 560 040  
info-hungary@eglo.com

**INDIA**

EGLO INDIA PRIVATE LIMITED

A-307, Ansal Chambers - 1, 3, Bhikaji Cama Place,  
110066 Delhi  
T: +91 85279 44288  
info-india@eglo.com

**ITALY**

EGLO ITALIANA S.R.L.

Via Giotto, 4  
31021 Mogliano Veneto (TV)  
T: +39 041 45 66 232 / -245/ -251 |  
F: +39 041 45 74 066 / -071  
info-italy@eglo.com

**KAZAKHSTAN**

EGLO KAZAKHSTAN LLP

Al-Farabi Avenue 7, Office 72, 14rd floor, Block 4A,  
Nurly-Tau Business Center  
50059 Almaty  
T: +7 727 293 25 20 | M: +7 701 031 00 00  
info-kazakhstan@eglo.com

**KOSOVO**

EGLO KOSOVA LLC

Lugisht e qytetit pn  
20000 Prizren  
T: +383 44 216 687 | SHOP: +383 49 699 100  
info-kosovo@eglo.com

**LATVIA**

MOODNE VALGUSTUS AS

Rävalapst.7  
10143 Tallinn  
T: +370 652 49923 | T: +372 667 6670  
info-latvia@eglo.com

**LITHUANIA**

MOODNE VALGUSTUS AS

Rävalapst.7  
10143 Tallinn  
T: +370 652 49923 | T: +372 667 6671  
info-latvia@eglo.com

**MAGYARORSZÁG – ÉRTÉKESÍTÉS**

EGLO LUX KFT.

Fő út. 143/A  
2120 Dunakeszi  
T: +36 27 341 353 | F: +36 27 341 409  
info-hungary@eglo.com

**MALAYSIA**

EGLO ASIA SDN BHD

No. 13, Jalan Pelukis U1/46B, Temasya 18, Glenmarie,  
40150 Shah Alam, Selangor Darul Ehsan  
T: +6011 1050 2336 | F: +603 5567 9415  
info-malaysia@eglo.com

**MEXICO**

EGLO MÉXICO ILUMINACIÓN S DE RL DE CV

Prolongación Avenida López Mateos Sur N°3561,  
Fraccionamiento Los Gavilanes  
C.P. 45645 Tlajomulco de Zúñiga | Jalisco  
T: +52 33 3687 20 95  
info-mexico@eglo.com

**MIDDLE EAST**

EGLO LIGHTING MIDDLE EAST FZE

P.O. BOX 262073, LOB6, OFFICE G18  
Jebel Ali, Dubai, UAE  
T: +97 148810080 | F: +97 148810081  
gulf@eglo.com

**MOROCCO - EGLO AFRICA**

EGLO MAGHREB LUMINAIRES SARL

219 Bd Med Zerktoouni. Suite: 67  
20330 Casablanca  
T: +212 522 98 80 25 / -05  
info-global@eglo.com | info.africa@eglo.com

**THE NETHERLANDS**

EGLO VERLICHTING NEDERLAND B.V.

Innovatiepark 20  
4906 AA Oosterhout (NBR)  
T: +31 162 48 28 30  
info.netherlands@eglo.com

**NORWAY**

MS Belysning AS

Heiaveien 4  
1900 Fetstund  
T: +47 63 888500 | F: +47 63 888501  
info-norway@eglo.com

**PERU**

EGLO PERU S.A.C

Av Primavera 1419  
Distrito de Santiago de Surco y Departamento de Lima  
T: +51 902 763 635  
info-peru@eglo.com

**POLAND**

EGLO POLSKA SP. Z O.O.

Ul. Dzwiekowa 2  
02-857 Warszawa  
T: +48 22 644 57 55 | F: +48 22 644 89 82  
info-poland@eglo.com

**PORTUGAL**

EGLO PORTUGAL ILUMINAÇÃO, LDA

Rua Fonte Parada, 125  
4595-434 Seroa-Paços de Ferreira  
T: +351 255 890 000 | F: +351 255 892 346  
info-portugal@eglo.com

**ROMANIA**

EGLO ROMANIA PRODEXIM SRL.

Str. Atomistilor nr. 1D  
77125 Magurele - Ilfov  
T: +40 314 250 902 | F: +40 314 250 899  
info-romania@eglo.com

**RUSSIA**

EGLO LIGHTING LLC

Varshavskoe shosse 3 | Office 23  
117105 Moscow  
T: +7495 789 4311 | F: +7495 789 4312  
info-russia@eglo.com

**SERBIA**

EGLO RASVETA DOO

Stefana Prvovenčanog 28  
11000 Beograd  
T: +381 11 3981 366 | F: +381 11 3981 389  
info-serbia@eglo.com

**SLOVAKIA**

EGLO CZ+SK s.r.o

Náchodská 2479/63  
193 00 Praha 9 Horní Počernice  
T: +421 313 211 551 | F: +421 313 211 556  
info-slovakia@eglo.com

**SLOVENIA**

EGLO RASVJETA D.O.O.

Jadranska avenija 9a  
10000 Zagreb  
T: +386 158 093 18  
info-slovenia@eglo.com

**SPAIN**

EGLO ESPAÑA ILUMINACION S.L.

Avda. de Castilla 1 (Edf. Best Point) 2º-16A  
28830 San Fernando de Henares, Madrid  
T: +34 91 677 9044 | F: +34 91 677 0304  
info-spain@eglo.com

**SWEDEN**

EGLO SVERIGE AB

Star Street 1  
512 50 Svenljunga  
T: +46 340 623 505 | F: +46 340 623 605  
info-sweden@eglo.com

**SWITZERLAND**

EGLO SCHWEIZ AG

Seetalstraße 142  
6032 Emmen  
T: +41 41 268 69 59 | F: +41 41 268 69 58  
info-switzerland@eglo.com

**TURKEY**

EGLO Aydınlatma ithalat ihracat Ltd. Şti.

Eyüp Sultan Mah. Sekmen Cad. No:18/2  
34855 Sancaktepe / Istanbul Samandira  
T: +90 216 311 09 -02 / -03 / -04 |  
F: +90 216 311 09 / -05  
info-turkey@eglo.com

**UKRAINE**

EGLO UKRAINE LTD

Vatslava Gavela boulevard, 6/7-A,  
03124 Kyiv  
T: +38 044 463 98 41 | F: +38 044 468 84 67  
info-ukraina@eglo.com

**USA**

EGLO USA, INC.

3640 Royal South Parkway  
30349 Atlanta, Georgia  
T: +1 404 477 5601 | F: +1 404 393 7053  
info-usa@eglo.com

# HOW TO READ

ERKLÄRUNG / COMMENT LIRE



PRODUCT / PRODUCT IN THE AMBIANCE  
PRODUKT / PRODUKTE IM AMBIENTE  
PRODUITS / PRODUITS DANS L'AMBIENCE

You can find the article number next to each product on the page and in the ambiance pictures.

Sie finden die Artikelnummer auf jeder Seite und neben jeder Abbildung des Produktes und auf unseren Ambientebildern.

Vous pouvez trouver le numéro d'article à la page et à côté de chaque produit dans les images de l'ambiance.

Trend & Style 2023/24 - Ethno Elegance

268

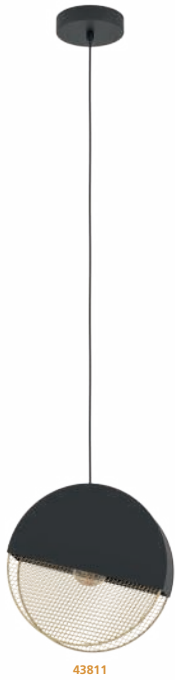

43811



43812

ARTICLE NUMBER & SERIES NAME  
ARTIKELNUMMER & SERIENNAME  
NUMÉRO D'ARTICLE & NOM DE LA SÉRIE

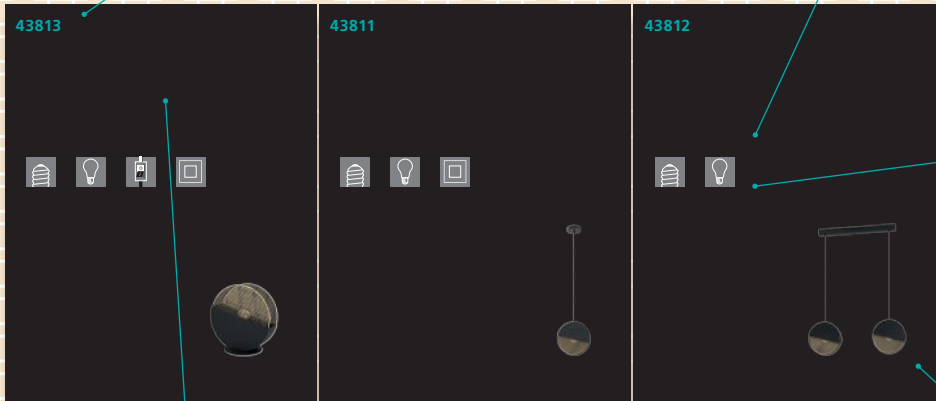

DESCRIPTION  
BESCHREIBUNG  
DESCRIPTION

The product description is composed as follows: luminaire type; enclosure material, enclosure colour / glass or shade material, glass or shade colour

Die Produktbeschreibung setzt sich wie folgt zusammen: Leuchtenart; Gehäusematerial, Gehäusefarbe / Schirm- bzw. Glasmaterial, Schirm- bzw. Glasfarbe

La description du produit est composée comme suit: type de luminaire; matériel de boîtier, couleur de boîtier / matériel de verre ou abat-jour, couleur de verre ou abat-jour

DIMENSIONS  
DIMENSIONEN  
DIMENSIONS

all dimensions in mm | alle Größen in mm | toutes dimensions en mm

L = length | Länge | longeur

B = width | Breite | largeur

H = height | Höhe | hauteur

Ø = diameter | Durchmesser | diamètre

A = projection length | Ausladung | amplitude

ET = installation depth | Einbautiefe | profondeur utile

Base = base dimensions | Sockelmaße | dimensions de base

Attention! The dimensions relate solely to the sizes of the luminaire. Any air spaces that would be relevant for a safe operating of the lamp were not considered.

Achtung! Die Größen beziehen sich nur auf die Abmessungen der Leuchte. Etwaige Lufträume, die für einen sicheren Betrieb der Leuchte notwendig sind, werden nicht berücksichtigt.

Attention! Les dimensions se réfèrent à la taille de la lampe seulement. Espacements éventuels, que seraient importants pour une opération de la lampe sans danger, n'ont pas été considérés.

PICTOGRAMMES  
PIKTOGRAMME  
PICTOGRAMMES

Technical details are represented as pictograms. An overview over all pictograms can be found on the next pages.

Technische Details werden als Piktogramme dargestellt. Eine Übersicht über alle Piktogramme finden Sie auf den nächsten Seiten.

Les détails techniques sont représentés sous forme de pictogrammes. Vous trouverez un aperçu de tous les pictogrammes dans les pages suivantes.

SKETCHES  
SKIZZEN  
CROQUIS

The sketches state the most meaningful dimensions. If a product is adjustable by will, a turquoise arrow marks this function and only the maximum dimensions are indicated.

Die Bemaßung der Skizzen umfasst jeweils die aussagekräftigsten Größen. Bei verstellbaren Produkten kennzeichnet ein türkiser Pfeil diese Funktion und nur die maximalen Größen werden angegeben.

Les dimensions des croquis comprennent les plus représentatives. Si un produit est réglable au choix, une flèche turquoise affiche cette fonction et rien que les dimensions maximales sont indiquées.

# HOW TO READ

## ERKLÄRUNG / COMMENT LIRE

1

PICTOGRAMMES  
PIKTOGRAMME  
PICTOGRAMMES

Technical details are represented as pictogrammes.

Technische Details werden als Piktogramme dargestellt.

Les détails techniques sont représentés sous forme de pictogrammes.



Lumen  
Lumen  
Lumen



Not suitable as main light source  
Nicht als Hauptleuchtmittel geeignet  
Ne convient pas comme source lumineuse principale



Dimensions in mm  
Abmessungen in mm  
Dimensions en mm



Wattage  
Wattage  
Puissance



Operating voltage  
Betriebsspannung  
Tension de fonctionnement



Socket  
Sockel  
Douille



Dimmable  
Dimmbar  
Dimmable



Not dimmable  
Nicht dimmbar  
Pas de gradation



Step dimmable  
Stufen dimmbar  
gradation par étapes



Control unit  
Stufen dimmbar  
unité de contrôle



Lifetime  
Steuereinheit  
Durée de vie



Selling Unit  
Verpackungseinheit  
Unité d'emballage



Comparative value of brightness to conventional light bulbs  
Vergleichswert der Helligkeit zu konventionellen Glühlampen  
Valeur comparative de la luminosité par rapport aux ampoules à incandescence conventionnelles



Colour rendering index  
Farbwiedergabeindex  
L'indice de restitution de couleurs



Beamangle  
Ausstrahlwinkel  
Angle de rayonnement



Day/night-sensor  
Tag/Nacht-Sensor  
Capteur jour/nuit



Motion-sensor  
Bewegungsmelder  
Détecteur de mouvement



Motion-sensor & day/night-sensor  
Bewegungsmelder & Tag/Nacht-Sensor  
Détecteur de mouvement et détecteur jour/nuit



incl. battery  
inkl. Batterie  
incl. pile

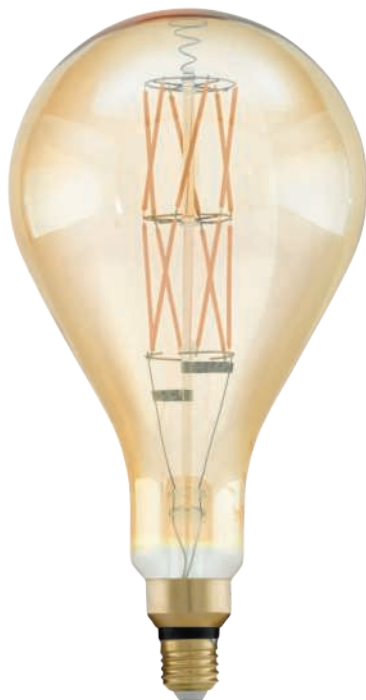

1

**110111 E27-LED-PS160**



**806 lm**

warm  
WHITE

**2100 K**



L 320, Ø 160



8 W ~ 60 W



8 W



80 CRI



220-240V, 50/60Hz



E27



dimmable



15000 h

















## 2

### LIGHT COLOUR & KELVIN LICHTFARBE & KELVIN COULEUR LUMINEUX & KELVIN

The colours of the LED are represented as pictogrammes (see below), their luminous flux directly beneath. The luminous flux is quoted in lumen and describes the amount of light generated by the LED. The higher the value, the brighter is the lamp. Lumens are LED boards and are the light measurement value in bulbs.

Die Farben der LED werden als Piktogramm (siehe unten) dargestellt, deren Lichtstrom direkt darunter. Der Lichtstrom wird in Lumen gemessen und gibt die erzeugte Lichtmenge der LED an. Je höher der Wert, desto heller das Produkt. Lichtstromangaben (Lumen) sind Platinen- bzw. Leuchtmittelwerte.

Les couleurs de DEL ont représentés sous forme de pictogrammes, leur flux lumineux directement en dessous. L'unité de flux lumineux est le lumen et il mesure la quantité de lumière générée par les DEL. Plus la valeur est élevée, plus la lampe est lumineuse. Les lumens sont l'unité de mesure de l'intensité lumineuse des ampoules et des panneaux led intégrés.

	RGB RGB RGB		RGB + neutralwhite RGB + neutralweiß RGB + blanc neutral		cold white kaltweiß blanc froid
	RGB + white RGB + weiß RGB + blanc		RGB + tunable white RGB + tunable white RGB + tunable white		neutral white neutralweiß blanc neutre
	RGB + warmwhite RGB + warmweiß RGB + blanc chaud		tunable white tunable white tunable white		Yellow Gelb Jaune
	RGB + coldwhite RGB + kaltweiß RGB + blanc froid		warm white warmweiß blanc chaud		Red Rot rouge

## 3

### ENERGY EFFICIENCY LABELS ENERGIEEFFIZIENZ-LABEL LABEL DE L'EFFICACITÉ ÉNERGÉTIQUE

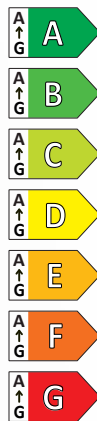
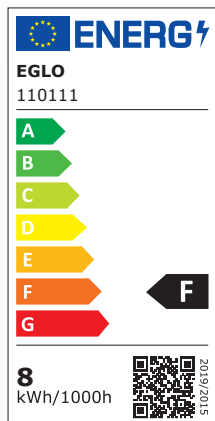

The new energy label must be indicated on all light sources with a luminous flux between 60 and 82,000 lumens and LED. This applies to lamps, LED modules and luminaires where the light source cannot be removed without destroying it. The energy spectrum ranges from A to G.

Das neue Energielabel muss auf allen Lichtquellen mit einem Lichtstrom zwischen 60 und 82.000 Lumen und LED angegeben werden. Dies gilt für Lampen, LED-Module und Leuchten, bei denen die Lichtquelle nicht zerstörungsfrei entnommen werden kann. Das Energiespektrum reicht von A bis G.

Le nouveau label énergétique doit être indiqué sur toutes les sources lumineuses dont le flux lumineux est compris entre 60 et 82 000 lumens et sur les LED. Cela s'applique aux lampes, aux modules LED et aux luminaires dont la source lumineuse ne peut être retirée sans être détruite. Le spectre énergétique va de A à G.



















The information on the label includes: / Die Angaben auf dem Etikett beinhalten: / Les informations figurant sur l'étiquette sont les suivantes :

- › Name/Trademark / Name/Warenzeichen / Nom/marque de commerce
- › Model / Modell / Modèle
- › Energy label scale A-G / Energielabel-Skala A-G / Échelle d'étiquetage énergétique A-G
- › Energy consumption for 1,000 hours of use / Energieverbrauch bei 1.000 Stunden Nutzung / Consommation d'énergie pour 1 000 heures d'utilisation
- › Energy efficiency class of the product / Energieeffizienzklasse des Produkts / Classe d'efficacité énergétique du produit
- › QR Code to EPREL (Product Database of the European Product Registry for Energylabelling) / QR Code zur EPREL (Produkt Datenbank der European Product Registry for Energylabelling) / Code QR pour EPREL (base de données des produits du registre européen des produits pour l'étiquetage énergétique)



















# LEGEND

## PICTOGRAM PIKTOGRAMME PICTOGRAMME

### SOCKETS FASSUNGEN DOUILLES

 LED	 G4	 G53
 2G7	 G5	 GU5,3 / MR16
 2G11	 G9	 GU10
 2GX13	 G10Q	 GX53
 E14	 G13	 GY6,35
 E27	 G23	 R7s

### BULBS LEUCHTMITTEL AMPOULES

 E14 / C35	 E27 / A60 Halogen	 E27 / E140 Filament
 E14 / C35f	 E27 / R63 Halogen	 E27 / PS160 Filament
 E14 / D45	 E27 / A60 LED	 E27 / T30 Filament
 E14 / C35f LED	 E27 / A60 Filament	 E27 / T32 Filament
 E14 / D45 Halogen	 E27 / A65 LED	 G4 / T9
 E14 / C35 Halogen	 E27 / A75 Filament	 G4 / LT9
 E14 / T22	 E27 / G45 LED	 G4 / LT14
 E14 / C35 Filament	 E27 / G45 Filament	 G9
 E14 / C37 Filament	 E27 / G80 Filament	 G9 LED
 E14 / C35f Filament	 E27 / G95	 GU10
 E14 / C37f Filament	 E27 / G95 Filament	 GU10 LED
 E14 / P45 LED	 E27 / G125	 GU10 SMD LED
 E14 / P45 Filament	 E27 / G95 LED	 GX53 / LF75
 E14 / P50	 E27 / G200 Filament	<b>LED</b> LED board / LED Platine / LED bord
 E14 / ST48 Filament	 E27 / R63 LED	 MR16
 E14 / ST64 Filament	 E27 / ST48 Filament	 MR16 LED
 E14 / T20 LED	 E27 / ST64 Filament	 R7s / 78mm
 E27 / A60	 E27 / B80 Filament	 R7s / 118mm
 E27 / G90	 E27 / BR150 Filament	 R7s / 78mm LED
 E27 / QR63	 E27 / DP165 Filament	 R7s / 118mm LED

**LIGHT COLOUR & LUMEN**  
**LICHTFARBE & LUMEN**  
**COULEUR LUMINEUX & LUMEN**

The colours of the LED are represented as pictogrammes (see below), their luminous flux directly beneath. The luminous flux is quoted in lumen and describes the amount of light generated by the LED. The higher the value, the brighter is the lamp. Lumens are LED boards and are the light measurement value in bulbs.

Die Farben der LED werden als Piktogramm (siehe unten) dargestellt, deren Lichtstrom direkt darunter. Der Lichtstrom wird in Lumen gemessen und gibt die erzeugte Lichtmenge der LED an. Je höher der Wert, desto heller das Produkt. Lichtstromangaben (Lumen) sind Platinen- bzw. Leuchtmittelwerte.

Les couleurs de LED ont représentés sous forme de pictogrammes, leur flux lumineux directement en dessous. L'unité de flux lumineux est le lumen et il mesure la quantité de lumière générée par les LED. Plus la valeur est élevée, plus la lampe est lumineuse. Les lumens sont l'unité de mesure de l'intensité lumineuse des ampoules et des panneaux led intégrés.

	RGB RGB RGB
	RGB + white RGB + weiß RGB + blanc
	RGB + warmwhite RGB + warmweiß RGB + blanc chaud
	RGB + coldwhite RGB + kaltweiß RGB + blanc froid
	RGB + neutralwhite RGB + neutralweiß RGB + blanc neutrale

	RGB + tunabel white RGB + tunabel white RGB + tunabel white
	tunable white tunable white tunable white
	warm white warmweiß blanc chaud
	cold white kaltweiß blanc froid
	neutral white neutralweiß blanc neutre

**SWITCHES & SENSORES**  
**SCHALTER & SENSOREN**  
**INTERRUPTEUR & CAPTEURS**

	incl. cable & plug inkl. Kabel & Stecker câble & connecteur inclus
	internal dimmer eingebauter Dimmer variateur intégré
	button switch Druckknopf interrupteur de pression
	function switch Funktionsschalter interrupteur fonction
	rocker switch Wippschalter interrupteur à bascule
	pedal dimmer Trittdimmer variateur à pied

	pedal switch Trittschalter interrupteur à pied
	cable switch Kabelschalter interrupteur à câble
	incl. cable & plug transformer inkl. Kabel & Stecktransformator câble & transformateur à prise
	remote control Fernbedienung télécommande
	Day & Night Sensor Tag & Nacht Sensor sensor jour & nuit
	sensor Sensor sensor

	swedish plug Stecker Schweden connecteur swede
	"Touch me" ON/OFF "Touch me" EIN/AUS "Touch me" ON/OFF
	"Touch me" ON/OFF & dimm "Touch me" EIN/AUS & Dimmen "Touch me" ON/OFF & graduable
	pull switch Zugschalter interrupteur à bascule
	Timer - automatic on/off Zeitschaltuhr - automatisches Ein- & Ausschalten minuterie - peut être éteint et allumé automatiquement

**FUNKTIONS & COMFORT**  
**FUNKTIONEN & KOMFORT**  
**FONCTIONS & COMFORT**

	incl. battery inkl. Akku incl. pile
	incl. battery inkl. Batterie incl. pile
	battery specifications Batteriespezifikationen spécifications des piles
	beam angle Ausstrahlwinkel angle de rayonnement
	corner mount possible Eckmontage möglich montage en coin possible
	CRI Colour Rendering Index

	cutout (in mm) Ausschnitt (in mm) perçage du panneau (en mm)
	dimmable dimmbar graduable
	not dimmable nicht dimmbar ne pas graduable
	replaceable LED austauschbare LED LED remplaçables
	loadable in kg belastbar in kg chargeable en kg
	packaging / delivery unit Verpackungs- / Liefereinheit unité d'emballage / de livraison

	shortable kürzbar réductible
	Voltage Volt Voltage
	Watt
	Flicker-Free Flacker-Frei Sans Vacillement
	not suitable for general lighting nicht für die Allgemeinbeleuchtung geeignet n'est pas approprié pour l'éclairage général

**PROTECTION CLASS**  
**SCHUTZKLASSE**  
**CLASSE DE PROTECTION**

The protection class indicates to what extent the lamp is protected against electric shock. All lamps in this catalogue are at least protected with the protection class 1 - a higher class is specified in the information box of the respective lamp.

Die Schutzklasse gibt an, inwiefern ein Produkt gegen einen elektrischen Schlag gesichert ist. Alle Leuchten in diesem Katalog sind mit mindestens Schutzklasse 1 gesichert, bei höheren Klassen wird das Symbol im Infokasten der Leuchte angegeben.

La classe de protection indique, dans quelle mesure la lampe est protégé contre les chocs électriques. Tous les lampes dans ce catalogue sont protégées au moins avec la classe 1 - une classe plus élevée est indiquée dans l'information de la lampe.

	protection class 1: protective earthing Schutzklasse 1: Schutzerdung classe de protection 1: prise de terre
--	---

	protection class 2: protective insulation Schutzklasse 2: Schutzisolierung classe de protection 2: double isolation ou renforcée
--	--

	protection class 3: protective low voltage Schutzklasse 3: Schutzkleinspannung classe de protection 3: très basse tension de sécurité
--	---

**PROTECTION RATING**  
**SCHUTZGRAD**  
**INDICE DE PROTECTION**

The protection rating ensures the operational safety of luminaires. The first number specifies the extent of the protection against the ingress of foreign bodies; the second number identifies the humidity protection grade. All luminaires in this catalogue are at least protected with the rating IP20 - a higher rating is specified in the information box of the luminaire.

Der Schutzgrad gewährleistet die Betriebssicherheit von Leuchten. Die erste Ziffer des IP Grades beschreibt den Schutzzumfang gegen das Eindringen von Fremdkörpern, die zweite Ziffer informiert über den Grad des Feuchtigkeitsschutzes. Alle Leuchten in diesem Katalog sind mit mindestens Schutzgrad IP20 gesichert, bei höheren Graden wird das Symbol im Infokasten der Leuchte angegeben.

L'indice de protection assure la sécurité opérationnelle des luminaires. Le premier chiffre indique à quel point la protection est efficace contre l'insertion de corps étrangers; le second chiffre indique quant à lui le degré de protection par rapport à l'humidité. Tous les luminaires dans ce catalogue sont protégés au moins avec l'indice IP20 - un indice plus élevé est indiqué dans l'information d'article.

	IP33
	IP44

	IP54
	IP65

	IP67
--	------

# Look out for this Logo!

## Achten Sie auf das Logo!

## Soyez attentif au logo !

### What is a forest?

A peaceful oasis, the green lungs of the world, and an adventure playground for children of all ages!

The Forest Stewardship Council® (FSC®) is a global, not-for-profit organisation dedicated to the promotion of responsible forest management worldwide. The FSC® defines standards for responsible forest management in accordance with established principles that are developed and supported by stakeholders from the environmental, social and economic spheres. For more information, please see [www.fsc.org](http://www.fsc.org).

### Was ist Wald für uns?

Eine Oase der Ruhe, die Lunge der Welt oder ein Abenteuerspielplatz für große und kleine Kinder!

Das Forest Stewardship Council® (FSC®) ist eine globale, gemeinnützige Organisation, mit dem Zweck verantwortungsvolle Waldbewirtschaftung weltweit zu fördern. FSC® definiert Standards für eine verantwortungsvolle Waldbewirtschaftung nach festgelegten Prinzipien, die von Interessenvertretern aus den Bereichen Umwelt, Soziales und Wirtschaft entwickelt und getragen werden. Für weitere Informationen besuchen Sie [www.fsc.org](http://www.fsc.org).

### Que représente la forêt pour nous ?

Une oasis de calme, les poumons du monde ou un terrain de jeu d'aventure pour les enfants de tous âges !

Le Forest Stewardship Council® (FSC®) est une organisation internationale à but non lucratif dont le but est de promouvoir une gestion forestière responsable dans le monde entier. Le FSC® définit des normes de gestion forestière responsable selon des principes établis qui sont développés et soutenus par les parties prenantes des secteurs environnemental, social et économique. Pour plus d'informations, veuillez consulter [www.fsc.org](http://www.fsc.org).

Look out for FSC® -certified products!  
Achten Sie auf FSC® -zertifizierte Produkte!  
Soyez attentif aux produits certifiés FSC® !



The mark of  
responsible forestry

# DIGITAL CATALOGUE

This year, we are also making the Trend & Style catalogue in front of you available online, including lots of extra information and additional features. In addition to search and filter functions, the online catalogue includes extensive product photos, videos and additional information, complementing the paper edition wonderfully. Take a look at

<https://catalogue.eglo.com>

In diesem Jahr präsentieren wir den vor Ihnen liegenden Trend & Style Katalog wieder als Online-Katalog mit vielen Zusatzinformationen und zusätzlichen Features. Neben Such- und Filterfunktionen bietet der Online-Katalog mit reichhaltigen Produktabbildungen, Videos und zusätzlichen Informationen einen erheblichen Mehrwert zur gebundenen Ausgabe. Klicken Sie sich rein unter <https://catalogue.eglo.com>

Cette année, nous présentons le catalogue Trend & Style devant vous pour la première fois en tant que catalogue en ligne avec de nombreuses informations complémentaires et des informations complémentaires Caractéristiques. Cette version contient de nombreuses informations et fonctionnalités complémentaires. Outre les fonctionnalités de recherche et de filtrage, le catalogue en ligne propose de nombreuses illustrations de produits, des vidéos et des informations complémentaires : une valeur ajoutée considérable par rapport à la version papier. Cliquez ici pour le découvrir : <https://catalogue.eglo.com>

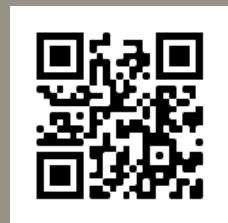

43956



# REGISTER

SERIES NAMES

SERIENNAMEN

NOME DE PRODUITS

NAME NAME NOM	PAGE SEITE PAGE	NAME NAME NOM	PAGE SEITE PAGE	NAME NAME NOM	PAGE SEITE PAGE	NAME NAME NOM	PAGE SEITE PAGE
ADWICKLE	209	CARDIGAN	272	EDALE	236	KILNSDALE	74
ALDERNEY	208	CARLTON	130-133	ELSWICK	56	KINROSS	246
ALSAGER	202-203	CARLTON 1	120-122, 126-128	EMBLETON	50	KIRKCOLM	228
AMSFIELD	225	CARLTON 2	140-141	EVESHAM	72-73	LACEY	86-87
AMSFIELD 1	226	CARLTON 4	124	FAMBOROUGH	94-95	LANTADA	171
ANWICK	210-211	CARLTON 5	125-126	FELIXKIRK	266	LAYHAM	70-71
ANWICK 1	212	CARLTON 6	124	FEMBARD	56	LEOMINSTER	215
ARNHEM	238-239	CARLTON 7	122-123	FINDLAY	257	LITTLETON	98-99
AUCKLAND	42	CARLTON-P	128-129	FRIJOLAS	192	LM_LED_E27	284-297
AUSNBY	219	CASTANUELO	148-149	GARGRAVE	251	LONGCINO	54
AUSTELL	164-165	CATTERICK	22-23	GATEBECK	64	LUBENHAM	36-37
AYCLIFFE	228	CAWTON	68-69	GILTSPUR	252	LUBENHAM 1	36
AYESGARTH	224	CHARTERHOUSE	55	GLASTONBURY	168	LYNTON	192
AYLES	89	CHASELY	80	GLYNEATH	218	MACCLES	66-67
BAILRIGG	106-107	CHESTER	172	GRANTHAM 1	40	MADRESELVA	82
BARLASTON	204-205	CHESTER 1	173	GRIZEDALE	266	MANBY	12-13
BARNSTAPLE	32-35	CHIEVELEY	90-91	HALKIN	92	MARDYKE	52-53
BARNSTAPLE 1	30-31	CHISLE	253	HAMBLETON	246	MATLOCK	186-189
BASILDON	102-103	CLAVERDON	222	HAPTON	177	MEDIOUNA	239
BASILDON 1	100	CLEVEDON	160	HARBOROUGH	72	MILLIGAN	6-7
BAZELY	183	CONSETT	92-93	HAXEY	228	MINTING	201
BIDFORD	171	COPLEY	174-175	HETTONLE	229	MONMOUNT	94
BORDESLEY	216-217	CORETTO 2	177	HORNWOOD	84-85	MUMBLES	269
BOYLE	82-83	COTTINGHAM	260	HORNWOOD 1	168	NAFFERTON	96-97
BRADFORD	242	COVALEDA	48	HORNWOOD 2	81	NEWTOWN	162-163
BRADFORD 1	243	CRANLEY	280	HYKEHAM	214-215	NIMLET	245
BRAMERTON	88-89	DELLOW	16-17	IKESTON	24-25	NOHALES	19
BRIDEKIRK	277	DEMBLEBY	220-221	IPSDEN	100	OLDBURY	58
BUTTERBURN	198-199	DISTAFF	118	JADIDA	274	OXPARK	196-197
CALARI	282	DUNDEE	173	JUBILY	8-9	PADSTOW	260
CALLOW	104	EBURY	39	KENSAL	245	PALMORLA	118
CAPOSILE	246			KILBURN	241	PLIMSOLL	167

NAME NAME NOM	PAGE SEITE PAGE	NAME NAME NOM	PAGE SEITE PAGE
POMPEYA	181	TALBOT 2	275
PONTEFRACT	11	TAMALLAT	276
PRESTWICK	192	TARBES	140,150- 151,153-157
PRESTWICK 1	63	TARBES 2	152
PRESTWICK 2	62-63	TARLE	261
PRESTWICK 3	190-191	TOWNSHEND	108-113
PRIDDY	44-46	TOWNSHEND 2	247
PRIDDY 1	42	TOWNSHEND 4	59-61
RAMPSIDE	257-259	TOWNSHEND 5	113-114,116
REDCLIFFE	20-21	TREBURLEY	48
RINROE	14-15	TRURO	42
ROCCAMENA	158-159	TRURO 1	40
RODING	262	TRURO 2	40,43
ROUNDHAM	15	TWICKEN	184-185
SAFI	272	VERNHAM	139
SALLICANO	183	VINOZA	250
SANDBACH	270	WILMCOTE	56
SEDBERGH	27	WINKWORTH 1	38
SHERBURN	105	WOOTTON	254-255
SHIREBROOK	31	WRINGTON	178-179
SOUTHERY	146-147	WRINGTON 1	181
SPEKE	26	YORTH	281-282
STAVERTON	277	YOUNGSTOWN	256
STILLINGTON	142-143		
STILLINGTON 1	144-145		
STOCKBURY	263		
STRAITON	136,176		
STYPE	134-135		
SUDBURY	275		
SURFLEET	232		
TABLEY	230-231		
TAKELEY	28		



# REGISTER

ARTICLE NUMBER  
ARTIKELNUMMER  
NUMÉROS D'ARTICLE

NUMBER NUMMER NUMÉRO	PAGE SEITE PAGE	NUMBER NUMMER NUMÉRO	PAGE SEITE PAGE	NUMBER NUMMER NUMÉRO	PAGE SEITE PAGE	NUMBER NUMMER NUMÉRO	PAGE SEITE PAGE	NUMBER NUMMER NUMÉRO	PAGE SEITE PAGE	NUMBER NUMMER NUMÉRO	PAGE SEITE PAGE
31073	282	43194	257	43415	95	43551	100	43635	82	43735	86
31075	282	43195	258	43416	95	43552	100	43636	83	43736	103
32468	179	43197	258	43424	84	43553	252	43641	94	43738	105
32539	282	43216	216	43426	168	43554	252	43642	245	43739	105
32915	110	43217	217	43427	168	43556	239	43643	52	43743	97
32916	110	43218	216	43431	30	43558	85	43644	53	43744	96
32917	111	43219	217	43432	30	43559	183	43645	52	43745	97
32918	111	43231	216	43433	30	43561	28	43646	52	43746	97
32919	111	43252	222	43434	31	43562	28	43652	245	43748	89
33162	109	43253	222	43435	38	43569	100	43653	245	43749	89
33163	109	43254	222	43436	38	43576	276	43654	152	43751	88
33164	108	43256	259	43443	148	43577	276	43655	152	43752	88
33165	108	43261	221	43459	80	43581	118	43661	9	43753	88
33166	108	43262	220	43461	102	43582	118	43662	8	43754	89
33167	109	43263	220	43462	102	43591	254	43663	8	43755	104
43001	127	43264	221	43463	103	43592	254	43664	8	43756	104
43002	126	43285	219	43464	103	43593	254	43665	9	43758	280
43004	140	43292	277	43466	70	43594	255	43666	9	43766	142
43045	84	43304	181	43468	70	43595	190	43668	183	43767	142
43046	84	43305	181	43469	70	43596	191	43669	183	43768	143
43047	85	43311	210	43471	71	43597	191	43671	81	43769	142
43048	85	43312	211	43481	139	43598	190	43678	153	43771	22
43057	124	43313	210	43482	139	43599	149	43679	150	43772	22
43058	124	43318	256	43483	139	43603	16	43681	150	43773	22
43077	125	43319	256	43499	253	43604	16	43682	151	43774	23
43078	126	43324	212	43522	59	43605	16	43683	151	43775	209
43096	179	43325	212	43523	60	43606	81	43684	153	43776	209
43113	228	43326	212	43524	60	43611	87	43685	153	43777	209
43126	56	43328	260	43525	61	43612	86	43692	134	43781	236
43129	80	43331	178	43526	61	43613	87	43693	135	43782	236
43131	114	43333	178	43527	253	43614	87	43695	134	43783	236
43132	114	43344	277	43528	253	43615	192	43696	135	43784	208
43133	116	43358	136	43531	17	43617	262	43715	123	43785	208
43134	113	43359	136	43532	17	43618	262	43716	122	43786	208
43135	114	43361	136	43533	17	43619	262	43717	123	43787	19
43136	116	43363	260	43534	20	43621	39	43718	123	43788	19
43137	116	43364	260	43535	20	43622	39	43721	26	43789	19
43141	168	43365	56	43536	21	43623	243	43722	26	43794	13
43152	59	43377	181	43537	21	43624	243	43723	225	43795	12
43159	72	43378	118	43538	21	43625	6	43724	92	43796	12
43162	36	43393	239	43541	90	43626	6	43725	93	43797	13
43163	37	43398	211	43542	91	43627	7	43726	31	43798	92
43164	36	43399	124	43543	91	43628	6	43728	24	43799	92
43165	37	43401	238	43544	91	43629	112	43729	25	43801	281
43166	37	43402	238	43545	82	43631	174	43731	24	43802	281
43168	36	43403	238	43546	82	43632	175	43732	25	43803	281
43184	48	43413	94	43548	63	43633	174	43733	62	43804	73
43192	258	43414	95	43549	63	43634	174	43734	63	43805	72



NUMBER NUMMER NUMÉRO	PAGE SEITE PAGE	NUMBER NUMMER NUMÉRO	PAGE SEITE PAGE	NUMBER NUMMER NUMÉRO	PAGE SEITE PAGE	NUMBER NUMMER NUMÉRO	PAGE SEITE PAGE	NUMBER NUMMER NUMÉRO	PAGE SEITE PAGE	NUMBER NUMMER NUMÉRO	PAGE SEITE PAGE
43806	73	43866	224	43953	68	49259	132	49647	34	94326	171
43807	73	43867	224	43954	69	49274	272	49648	33	94742	177
43808	149	43868	229	43955	67	49283	242	49649	32	95499	110
43809	149	43869	228	43956	66	49284	242	49652	32	110095	284
43811	269	43871	228	43958	67	49342	173	49653	32	110096	285
43812	269	43872	218	43959	67	49385	172	49684	58	110097	285
43813	269	43873	218	43961	204	49386	172	49685	58	110098	286
43814	131	43874	232	43962	205	49392	55	49694	257	110099	286
43815	131	43878	44	43963	15	49393	55	49698	99	110101	287
43816	147	43883	215	43964	15	49394	55	49717	275	110102	288
43817	146	43885	266	43965	14	49446	165	49718	34	110103	288
43818	146	43886	266	43966	14	49447	164	49722	34	110104	289
43819	146	43891	11	43967	15	49448	164	49724	246	110105	289
43821	27	43892	11	43968	14	49449	177	49736	176	110106	290
43822	27	43895	201	43973	205	49456	263	49738	176	110107	290
43823	250	43901	106	43974	230	49457	263	49744	113	110108	291
43824	250	43902	107	43975	231	49458	263	49755	112	110109	292
43825	186	43903	106	43976	231	49464	44	49761	50	110111	292
43826	187	43904	106	43977	230	49465	45	49762	50	110112	293
43827	188	43908	130	43978	230	49466	45	49764	274	110113	296
43828	188	43909	130	43979	270	49468	46	49765	274	110114	296
43829	188	43921	241	43981	270	49469	46	49771	225	110115	297
43831	219	43922	241	43982	270	49471	46	49772	225	110116	297
43832	74	43923	241	43984	202	49472	162	49812	192	110117	294
43833	74	43925	145	43985	202	49473	98	49819	40	110118	295
43834	74	43926	144	43986	203	49474	163	49851	246	110119	295
43835	185	43927	144	43987	202	49475	98	49859	61		
43836	185	43928	144	49024	129	49477	162	49871	272		
43837	185	43929	251	49026	128	49478	162	49878	120		
43838	184	43931	266	49076	64	49479	163	49927	247		
43839	184	43932	201	49077	64	49481	163	49931	128		
43841	184	43933	201	49078	64	49487	141	49932	126		
43842	187	43934	232	49081	140	49488	140	49933	132		
43843	189	43935	198	49111	192	49489	246	49935	133		
43844	187	43936	199	49142	160	49492	42	49991	121		
43845	261	43937	199	49143	160	49495	54	49992	121		
43846	122	43938	198	49148	171	49496	54	49994	121		
43847	167	43939	198	49213	242	49509	165	49997	120		
43848	167	43941	196	49221	275	49519	173	94187	154		
43849	167	43942	196	49235	42	49549	99	94188	154		
43851	214	43943	196	49238	40	49564	56	94189	155		
43852	215	43944	197	49243	42	49617	48	94191	154		
43853	214	43945	197	49247	40	49618	48	94192	155		
43854	214	43946	205	49248	43	49619	35	94193	157		
43855	215	43948	68	49254	120	49643	158	94194	156		
43863	226	43949	68	49255	128	49644	158	94195	156		
43864	226	43951	69	49257	133	49645	159	94196	157		
43865	226	43952	69	49258	132	49646	159	94324	171		



All previous catalogues and price lists are no longer valid with the issue of this catalogue. Errors, misprints, model and price changes and technical modifications are reserved. We deliver based on our terms of delivery and payment. Our products comply with the European light norm EN60598. Products with the ENEC test mark are conforming to the guide line 2006/95/EG. Products with additional safety remarks (e.g protection class, IP) are identified within the product family with the relevant symbol and number. The content of this catalogue is protected under copyright law for EGLO Leuchten GmbH. All rights reserved. Our specific written consent must be obtained before using any illustrations and texts. The pictures are 4C prints and may differ from the original. The product pictures and ambiances in this catalogue can deviate from reality, and they do not necessarily concur with the usual application of the product. EGLO does not assume liability for the correctness, completeness or the application depiction of the products and/or the product information.

Design, layout and composition:

EGLO GmbH, 6136 Pill - AUSTRIA

Print: Samson Druck GmbH, 5581 St. Margarethen - AUSTRIA

Pictures: EGLO, Adobe Stock, istockphoto.com, shutterstock.com

Mit diesem Katalog verlieren alle vorhergehenden Kataloge und Preislisten ihre Gültigkeit. Irrtümer, Druckfehler, Modell- und Preisänderungen sowie technische Änderungen vorbehalten. Wir liefern zu unseren Liefer- und Zahlungsbedingungen. Unsere Produkte entsprechen der europäischen Leuchtennorm EN 60598. Produkte mit dem ENEC Prüfzeichen sind konform mit der Richtlinie 2006/95/EG. Produkte mit weiteren Sicherheitshinweisen (zB. Schutzklasse, IP) sind mit Symbol und Zahl bei der Produktfamilie ausgezeichnet. Der Inhalt dieses Kataloges ist für die EGLO Leuchten GmbH urheberrechtlich geschützt. Alle Rechte sind vorbehalten. Bilder und Texte dürfen nicht ohne vorherige ausdrückliche, schriftliche Genehmigung verwendet werden. Die Abbildungen sind 4C Drucke und können vom Original abweichen.

Die Katalogbilder und die gezeigten Darstellungen der Produkte können von der Wirklichkeit abweichen und nicht den üblichen Produktanwendungen entsprechen. EGLO übernimmt keine Haftung für die Richtigkeit, Vollständigkeit und Anwendungsdarstellung der Produkte und Produktinformationen.

Gestaltung, Layout und Satz:

EGLO GmbH, A-6136 Pill - AUSTRIA

Druck: Samson Druck GmbH, 5581 St. Margarethen - AUSTRIA

Bilder: EGLO, Adobe Stock, istockphoto.com, shutterstock.com

Le présent catalogue remplace tous les catalogues et tarifs précédents. Sous réserve d'erreurs, de fautes d'impression, de modification des modèles et de changement de prix et de technique. Nous livrons sur la base de nos conditions de livraison et de paiement. Nos produits sont conformes aux normes européennes EN 60598 et portent le marquage CE. Les produits portant la marque ENEC sont conformes à la Directive 2006/95/EG. Les produits portant d'autres indications de sécurité (par exemple classe de protection, IP) sont identifiés par le symbole et le nombre correspondants dans la famille de produits.

Le contenu du présent catalogue est protégé pour la société EGLO Leuchten GmbH par un copyright. Tous droits réservés. Toute reproduction d'images et du texte est interdite sans autorisation explicite par écrit préalable. Les images sont imprimées en 4C et peuvent différer de l'original.

Les images des produits et les ambiances dans le catalogue peuvent dévier de la réalité et ne sont pas nécessairement en ligne avec l'usage habituel du produit. EGLO n'engage pas sa responsabilité sur la justesse des images et sur les informations relatives à l'usage pouvant être fait des produits.

Conception, maquette et composition :

EGLO GmbH, A-6136 Pill - AUSTRIA

Presse: Samson Druck GmbH, 5581 St. Margarethen - AUSTRIA

Images: EGLO, Adobe Stock, istockphoto.com, shutterstock.com

03-2023





**EGLO**  
my light | my style

EGLO Leuchten GmbH  
Heiligkreuz 22  
A-6136 Pill  
Austria  
Tel. +43 (0) 5242 6996  
Fax +43 (0) 5242 6996-972  
info@eglo.com  
www.eglo.com



KATTR23

my light | my style