

What's **this**?

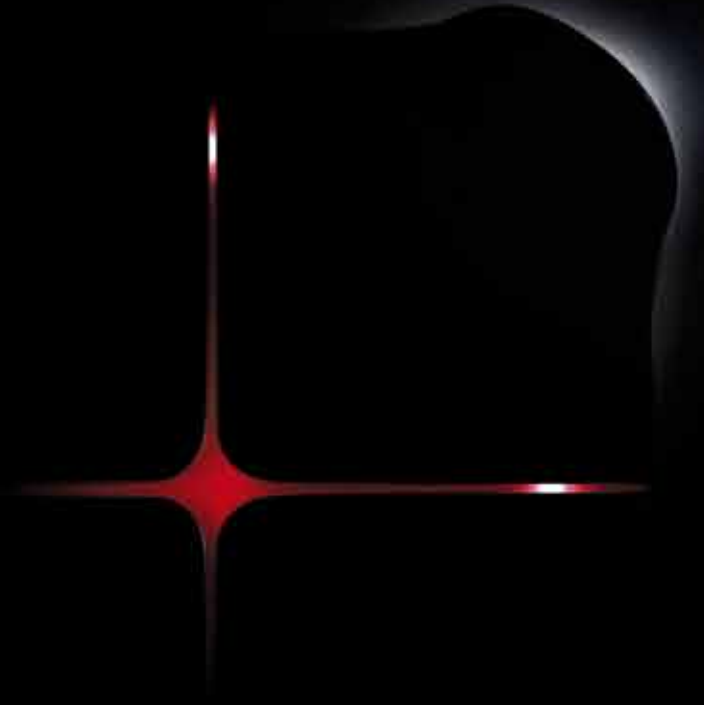

AULIX lighting

návrhy osvětlení a prodej svítidel

SVĚTELNÉ STUDIO

U Náměstí 708 (vchod z náměstí)
252 41 Dolní Břežany (Praha západ)

Tel.: +420 241 402 565
E-mail: info@aulix.cz
Skype: studio.aulix
Web: www.aulix.cz
E-shop: <http://obchod.aulix.cz>

KONTAKTY:

Radek Motyka

ředitel, návrhy osvětlení

mobil: +420 774 633 636
e-mail: motyka@aulix.cz
skype: radek.motyka.aulix

Jan Široký

návrhy osvětlení, velkoobchod

mobil: +420 776 333 364
e-mail: siroky@aulix.cz
skype: jan.siroky.aulix

Ing. David Holešta

office manager

mobil: +420 776 333 324
e-mail: holesta@aulix.cz
skype: david.holesta.aulix

Bc. Gabriela Široká

marketing, e-shop

mobil: +420 720 115 467
e-mail: marketing@aulix.cz
skype: gabriela.siroka.aulix

Morava + Slovensko

mobil: +420 773 334 344

eelecta®

You, in an homy and environmental world

eelecta is a product range dedicated to democratic, smart and creative design.

To the interaction between users and lighting control, energy saving, temperature control, entertainment.

To an efficient use of space.

To cost effective solutions for an eco-friendly environment.

To private homes, buildings, hospitality.

Creative Design: Marco Fossati

Not a switch





Choose your living space

Pro active management of power and lighting systems allows the environmental control and maximize energy savings

Lighting control

Dimming, lighting sequences control, management of "in colour" scenarios using led technology



Programmed setting of electrical functions

Scenarios - Absence, party, relax... - Socket power control

Enjoy Wellness and Comfort

While ensuring optimal power consumption, and all related operating savings



Differentiated temperature setting

With an integrated thermostat, detecting and regulating a desired temperature



Audio/Video source selection

Channel, station, local volume and track selection



Safety and centralized control

In one touch, full control of the property is provided and ensured in simplicity

Centralized management of valves and loads

Shutters, irrigation, external drives, gates



Event based or occupancy based automation

A scenario or a given automation can be launched from an external device connected to the HomePad, as for example a traditional occupancy sensor

“Hidden” Functions

To be activated with a long pressure lenght on the Pad



Big like this:

Eelecta is a design and architectural element shaped to leave a coloured and graphical sign in the space. Create your artwork on artwork.eelectron.com

- More design
- More colours and personalized graphics: the HomePad doesn't want to be hidden
- Clear and easy function signalling throughout icons and colours

Eelecta gives you a wide range of possibilities to customize graphic and aesthetic

Sign your style and personality

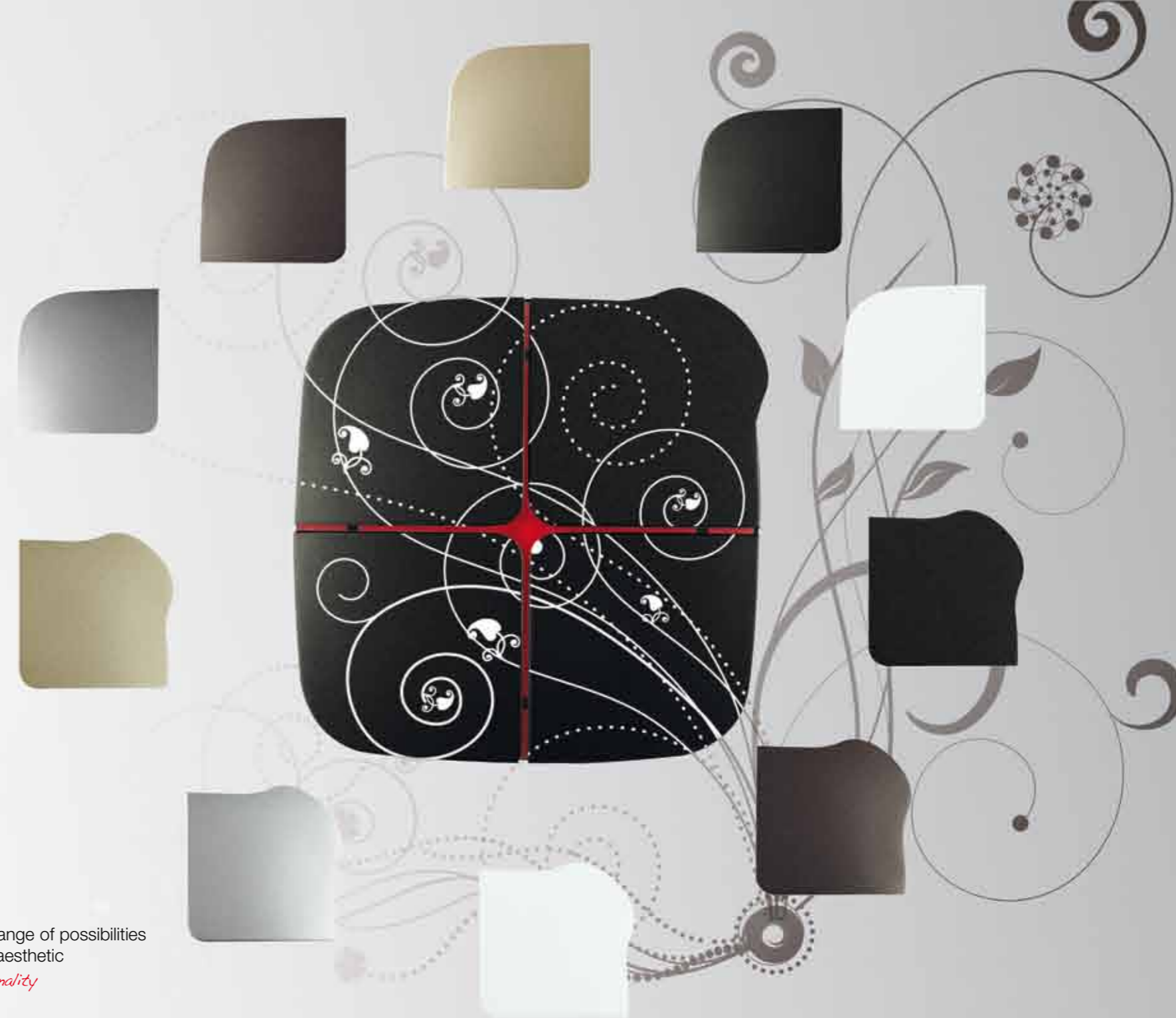

Artwork:

Elio Mariani

One of the creative leaders of MecArt. He goes through visual communication and image production, bringing on a critic to mass market society and using serial processes as a way to democratic art. To the account of Eelecta, he has defined 4 Artworks from his collection.



Elio Mariani and Andy Warhol,
New York - 1977



Order codes are referred to artworks of Elio Mariani on cover pad
and has to be completed with functional codes. (es. PB40B3DKNX -M1)



Artwork 001 - Elio Mariani, detail from masterpiece "Figura stracciata"
3D - M1



Artwork 002 - Elio Mariani, detail from masterpiece "Enigma"
3C - M2



Artwork 003 - Elio Mariani, detail from masterpiece "Ballerina"
1C - M3



Artwork 004 - Elio Mariani, detail from masterpiece "La Bouche"
1C - M4

Linear Cover



Wave Cover



HomePads

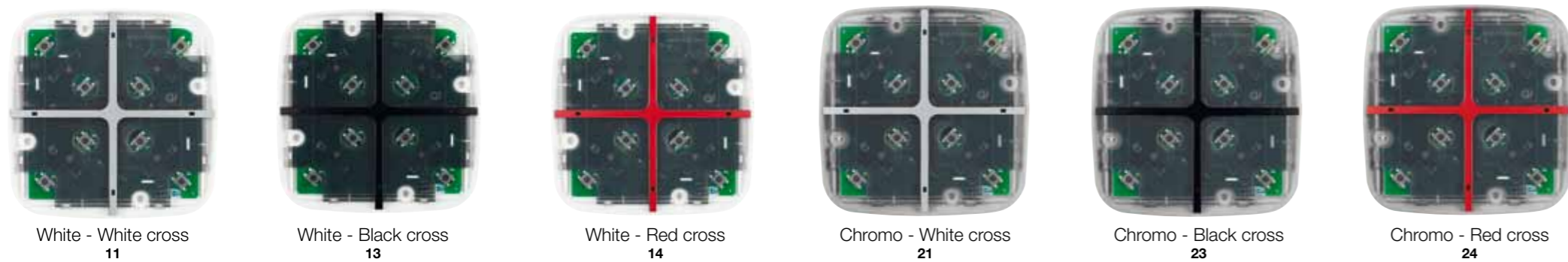

Codes	Description
PB40AxxCON	• HomePad 4 CH.
PB40BxxKNX	• HomePad KNX 4 CH.
PB40CxxKNX	• HomePad KNX 4 CH. 4 IN - TS
PB80AxxKNX	• HomePad KNX 8 CH. - TS
PB80BxxKNX	• HomePad KNX 8 CH. - 4 IN

Order codes are referred to colour palette and has to be completed with functional codes. (es. PB40B11KNX)

Complete HomePads available on all functional models



Order codes are referred to colour palette and has to be completed with functional codes. (es. PB40B3DKNX -BW)

Examples of personalized models available on all functional models



... design your style

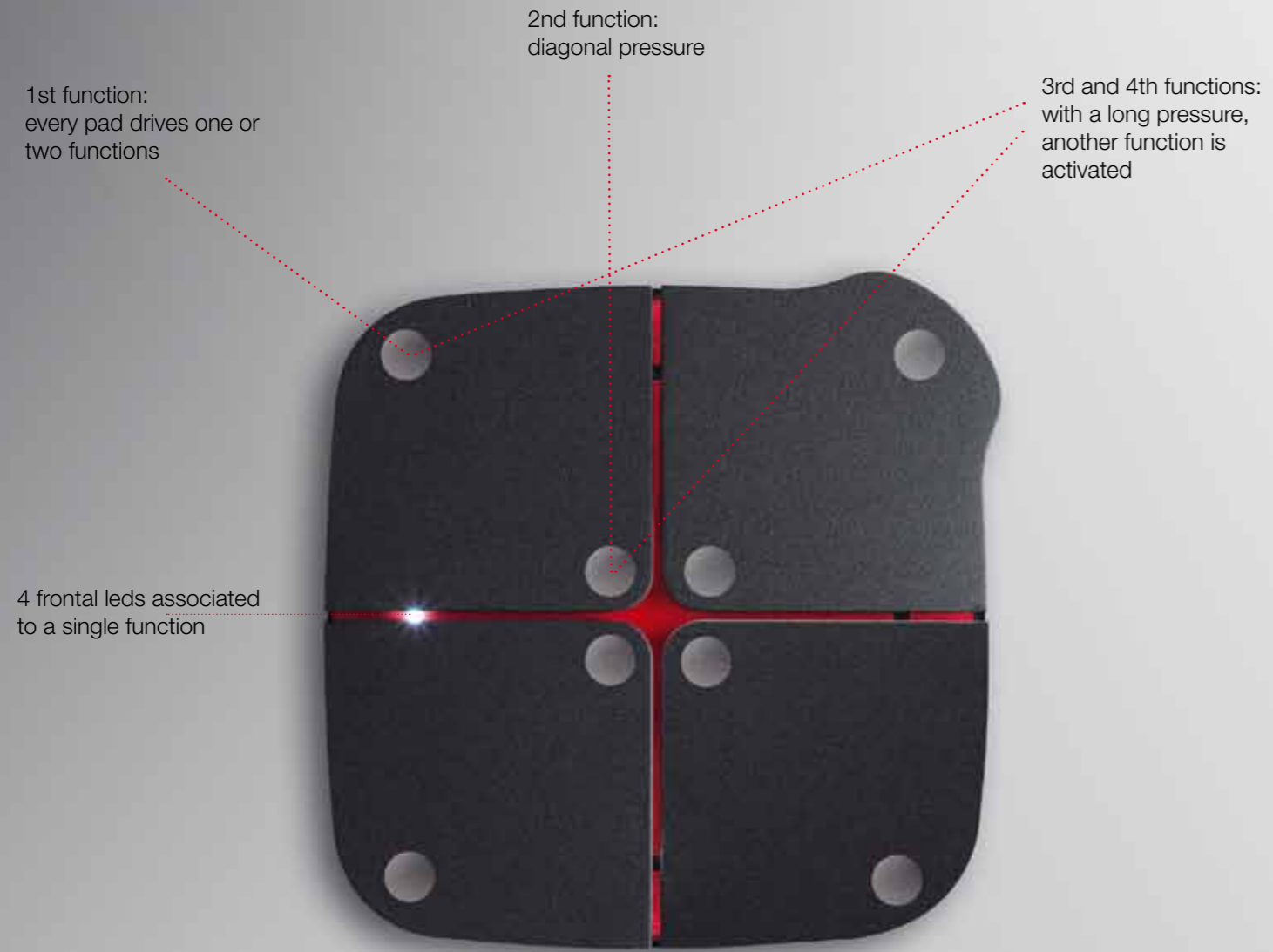

HomePad is available with 4 or 8 channels (functions), with thermostat and 4 inputs interface options

How it works

Lateral programmable led for night mode or night light

Integrated thermostat

Until 4 external devices (standard switches, presence sensor, etc.) can be connected to the HomePad to activate smart functions

Direct KNX bus connection



How to wire

What is it changing?

- Limited occupied spaces
- Lower costs and reduced electrical supply through the inclusion of several functions in just one device
- Limited wall breaking
- Less electrical cabling
- All in **KNX** standard and in 2 or 3 modules standard boxes

* Size and measures are based on examples, and they may change as resulting with the used system.

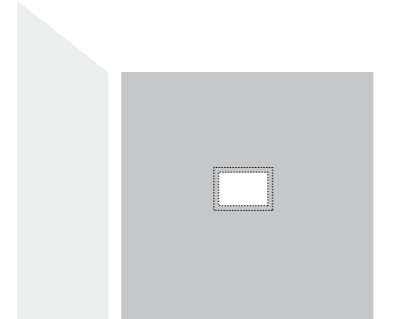
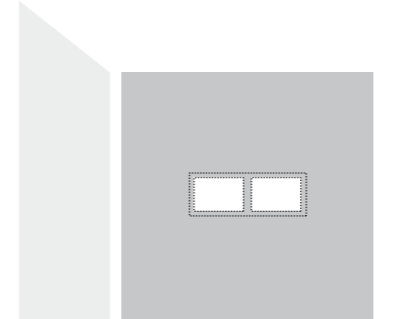
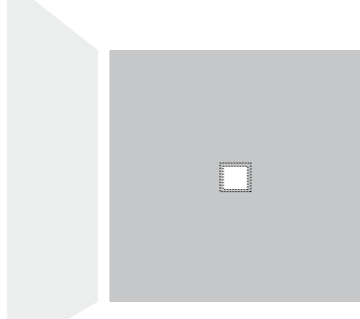
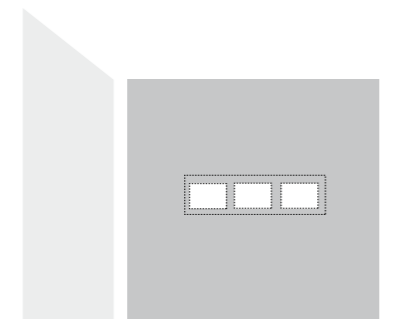
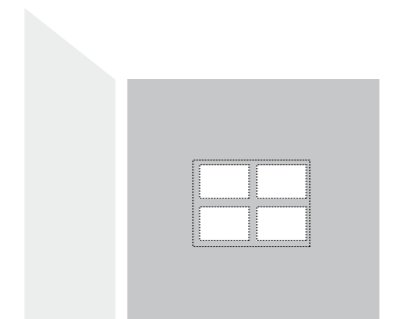
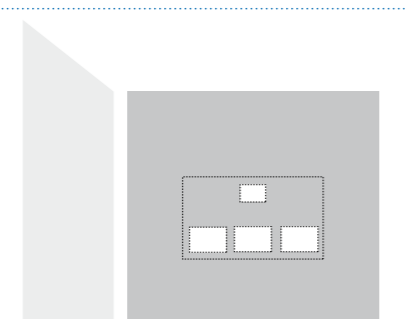
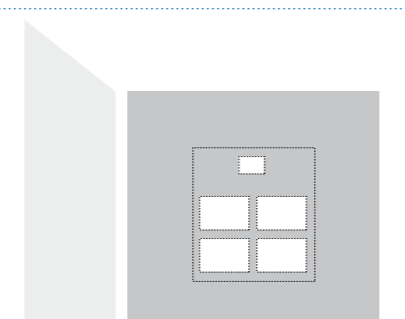
	Traditional installation	Standard home automation system	eelecta
4 channels*	 4 module boxes 74x132 mm.	 2 x 4 module boxes 2 x (74x132 mm.)	 With the eelecta's range you can get the same result with a single box of 2/3 modules. (71x70,8 mm. - 74x107 mm.)
8 channels*	 3 x 3 module boxes 3 x (74x107 mm.)	 4 x 4 module boxes 4 x (74x132 mm.)	
8 channels + Thermostat*	 3 x3 module boxes + Thermostat 3 x (74x107 mm.) + 74x107 mm.	 4 x 4 module boxes + Thermostat 4 x (74x132 mm.) + 74x107 mm.	

Dimensions

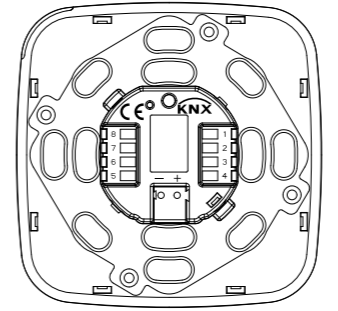
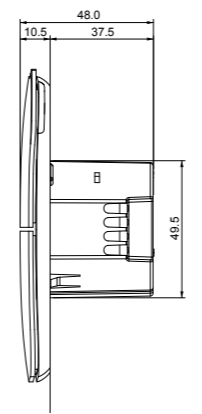
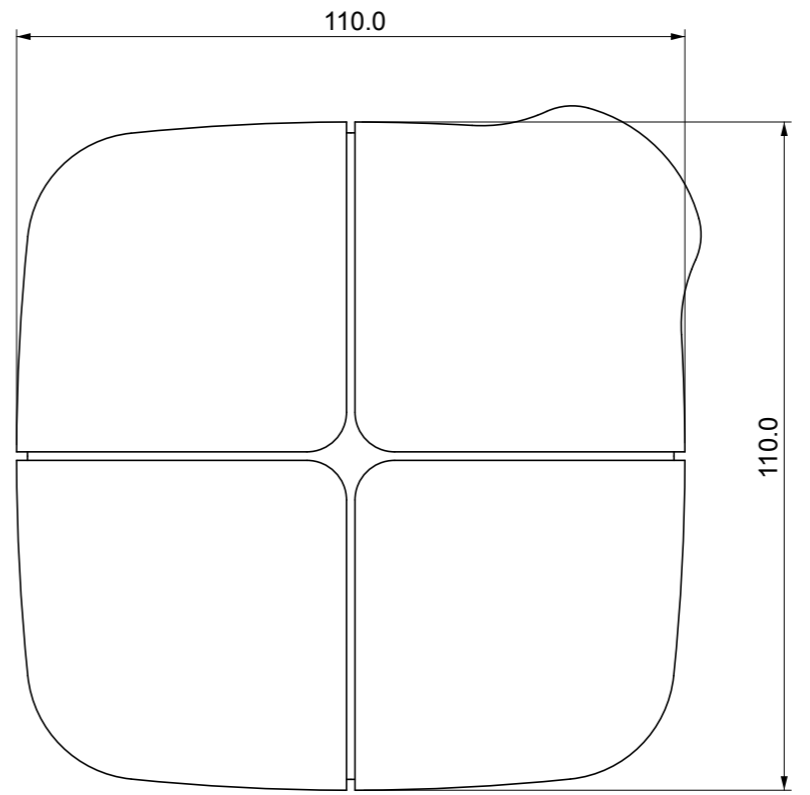

Mounting

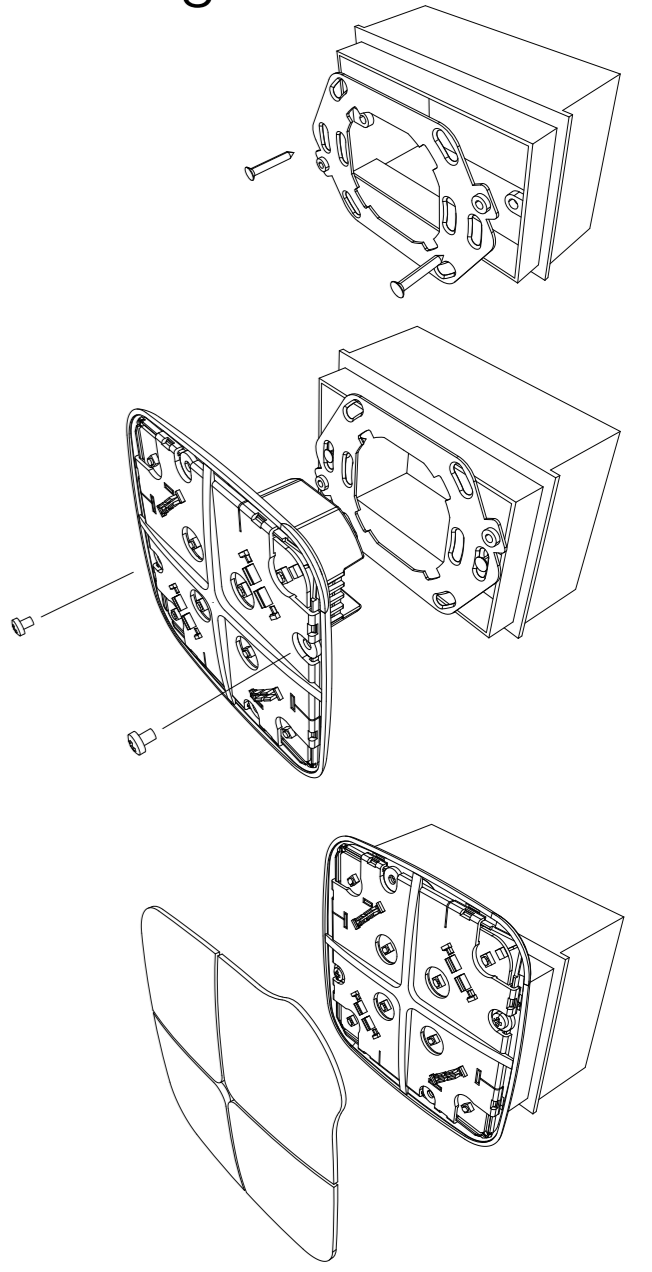

eelecta is based on standard 2 or 3 module boxes, horizontal or vertical mounted, and is compatible with the swiss standard

eelecta 3,5" touch panel

In a small space, in a distinctive shape, we have focused all our attention. Far from outward appearances, we have privileged the essence of an advanced interface, as expected by users



Colour palette



Personalized: Screen savers with personal photographs, **icons, skins, colour** and **menu**.



Info

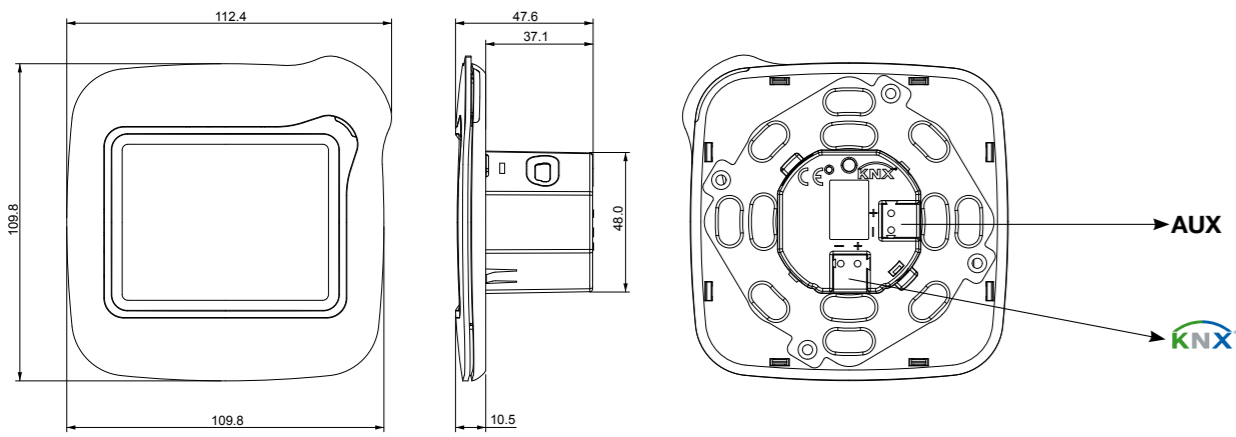

Modular installation:
round or squared 2 modules box, rectangular 3 modules box, horizontal or vertical.

- Direct KNX bus connection
- 12/30 Volt DC power supply
- Integrated buzzer for alarm signalling
- Frontal led for signalling or night light
- Programmable pages with 8 functions + 1 alarm page
- Settable password protection
- Integrated thermostat
- Supercap battery for clock memory after temporary (24h) black out.

Tarif and load control
With a clever management of energy related expenditures, energy saving goes along with control and efficiency.

Temperature control and management - local or zone based.
The touch panel has an integrated thermostat, managing 2 or 4 pipes systems, residential systems, air conditioning. Every temperature zone dedected from HomePads is programmed on an hour, day and week base.

Colour selection for RGB/DMX lighting on colour palette.
Coloured light sequences, programmed to show emotional scenarios, design and wellness environments.

Scenarios, shutters, lights, external drives, loads management
One only control point to detect, program and manage every home function.

Timers, irrigation, morning clock
Every event is timed: even your morning wake up.

Entertainment
From the touch panel, audio systems and external devices (TV, STEREO, etc.), are managed selecting tracks, volumes, sources, artists.



Typical configuration: room controller

- ON/OFF lights, Dimming, RGB lights, Scenarios, Shutters
- Temperature sensor with fancoil controller
- Morning clock and integrated alarm
- Personalized screensaver with welcome hotel message
- Services: do not disturb, make up room, service call, etc

eelecta for hotel services



Typical configuration: bed side panel















- Local lights
- Do not disturb / make up room
- 2 lighting scenarios
- Temperature control



Synchronicity | 

Synchronicity is a range of products working on KNX standard, dedicated to hotel and facility management. All the range is for both 2 modules round and squared inwall boxes or for 3 modules boxes. The solution is integrated with eHotel, eAccess and eSuite software management tools and products for temperature control (fan coil control, fans, proportional valves, air conditioning, 2 or 4 pipes systems, humidity sensors), lighting and load management (input and output modules, digital/analog mixed modules, dimmers and shutters modules), visualization and control (touch panels, PDA), communication (gateways vs. other protocols), multimedia (audio multiroom system).

Design: Paolo H. Castiglioni

System Components	I/O Modules, Shutters, Dimmer	eelecta	Synchronicity	Presence Detector KNX
 <ul style="list-style-type: none"> Power Supply 160, 320, 640 mA 	 <ul style="list-style-type: none"> Push Button Interface 2 IN - 2 OUT led Push Button Interface 4 IN - 4 OUT led 	 <ul style="list-style-type: none"> 3,5" KNX touch panel 	 <ul style="list-style-type: none"> Transponder Reader with or without frame Transponder Holder with or without frame Transponder Reader with bell External Transponder Reader Transponder Encoder 	 <ul style="list-style-type: none"> Presence Detector 1 or 2 ch.
 <ul style="list-style-type: none"> Line Coupler 	 <ul style="list-style-type: none"> 4 IN - 4 OUT Universal Module 8 IN - 8 OUT Universal Module 8 IN - 8 OUT Module 4 IN - 2 OUT Shutters/Blind Module 	 <ul style="list-style-type: none"> HomePad 4 CH. HomePad KNX 4 CH. HomePad KNX 4 ch 4 IN - TS HomePad KNX 8 CH. - TS HomePad KNX 8 CH. - 4 IN 	 <ul style="list-style-type: none"> Thermostat with or without frame Room Controller with or without frame 	
 <ul style="list-style-type: none"> USB, IP, IP router Interface 			 <ul style="list-style-type: none"> Transponder Card Transponder Keyholder 	
	 <ul style="list-style-type: none"> 3 CH. x 300 W Dimmer Module 3 CH. x 1-10V Dimmer Module 			
eelecta's Complements				
eelecta's Complements	Software	Accessories		
 <ul style="list-style-type: none"> Energy meter single phase with KNX interface Energy meter three phase with KNX interface DMX interface 	 <ul style="list-style-type: none"> eSuite eHotel eAccess 	 <ul style="list-style-type: none"> KNX bus cable 1x2x0,8 - 2x2x0,8 	 For more informations about our products please visit: www.eelectron.com	