



L
L
G
H
T
I
N
G

LASVIT

Pendants
& Chandeliers
Floor, Table,
Wall & Ceiling
Lamps



Lasvit is a global pacesetter for creating daring, unique spacial and lighting experiences that are designed to elevate the feelings and the aesthetic taste of everyone. Founded by Leon Jakimič, Lasvit is a visionary leader in the design industry with a boundless optimism and passion for making inviting art and design by fusing the traditional with the modern.

A progressive spacial concept company schooled in the long tradition of Bohemian Glassworks, Lasvit is a hub of uniquely creative art, design and production talent that creates breathtaking bespoke installations exhibited the world over, as well as uniquely stunning glass lighting and glassware collections.

Lasvit's unformulaic and bold approach has captivated the global design industry, even winning them the design "Oscar" award at Salone del Mobile.

Over the years, Lasvit has attracted renowned designers and artists who wish to collaborate with a unique and unconventional Czech company. Together with such influential voices as The Campana Brothers, Kengo Kuma, Yabu Pushelberg, Nendo and Ross Lovegrove, Lasvit has helped their partners create the most unforgettable glass collections through uninhibited artistry and unparalleled craftsmanship.

Lasvit is dedicated to a singular mission: To "Lift everyone" by creating sublime spacial experiences that touch the soul of all who look upon them.

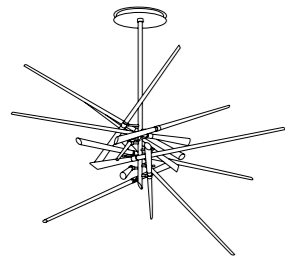

And Why Not!
→ 94—95

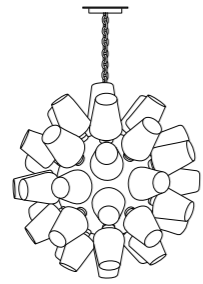

Candy Sphere
→ 70—71

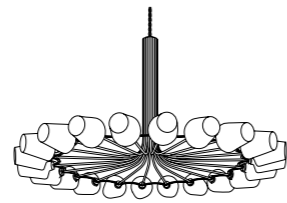

Candy Ring
→ 70—71

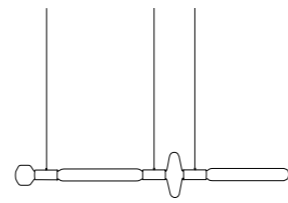

Cipher Horizontal S
→ 24—27

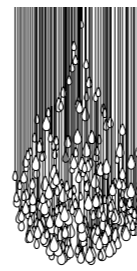

Droplets Small on Ceiling
→ 46—47



Duna Pendant
→ 38—41



Duna Wall Sconce
→ 98

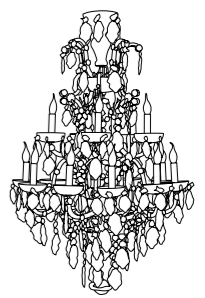

Empress S
→ 72—73

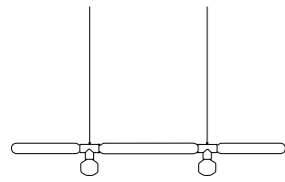

Cipher Horizontal L
→ 24—27

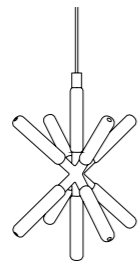

Cipher Star
→ 28—29



Cipher Vertical S
→ 28—29



Cipher Vertical L
→ 28—29



Empress L
→ 72—73

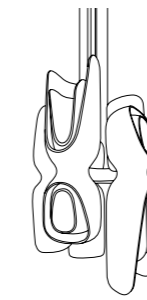

Eve
→ 48—49

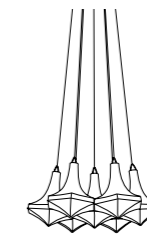

Facet Cluster of 7
→ 74—75

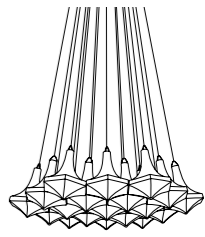

Facet Cluster of 19
→ 74—75

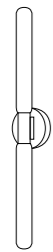

Cipher Wall Sconce
→ 94—95

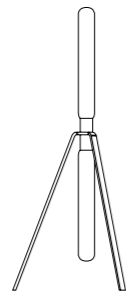

Cipher Floor Lamp
→ 106

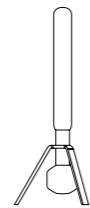

Cipher Table Lamp L
→ 118—119



Cipher Table Lamp S
→ 118—119

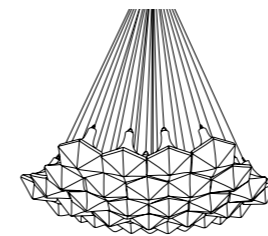

Facet Cluster of 37
→ 74—75



Flux Table Lamp
→ 122

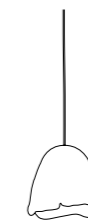

Frozen S
→ 76—77

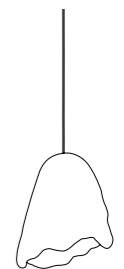

Frozen L
→ 76—77

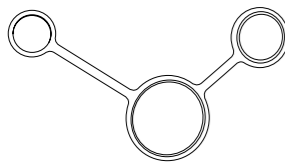

Constellation Wall Sconce Tri Star
→ 96—97

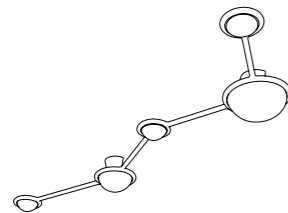

Constellation Ceiling Cassiopeia
→ 96—97



Constellation Floor Lamp Polaris
→ 107

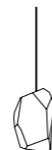

Crystal Rock Single
→ 18—23

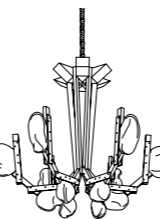

Fungo S
→ 78—79

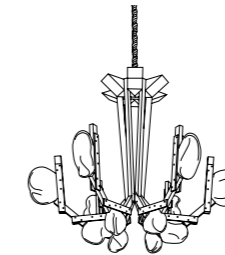

Fungo L
→ 78—79

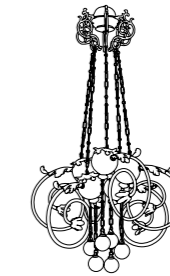

Galaxy Luminia
→ 80—81

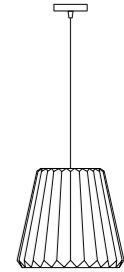

Glitters Single
→ 50—51

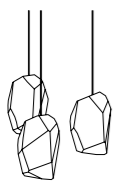

Crystal Rock Cluster of 3
→ 18—23

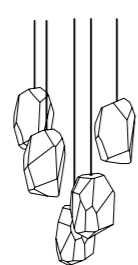

Crystal Rock Cluster of 5
→ 18—23



Crystal Rock Table Lamp
→ 120—121

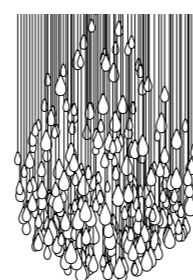

Droplets Large on Ceiling
→ 46—47

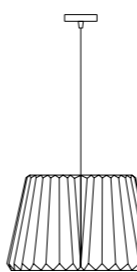

Glitters Double
→ 50—51

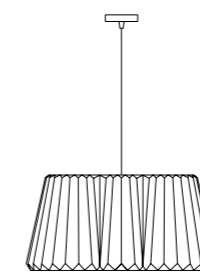

Glitters Triple
→ 50—51

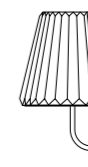

Glitters Wall Sconce
→ 99

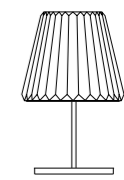

Glitters Table Lamp
→ 123

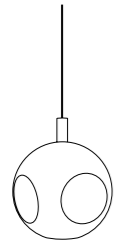

Globe Metro
→ 052—53

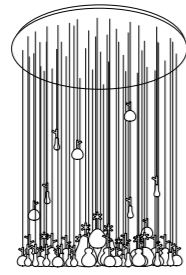

Growing Vases
→ 082—83

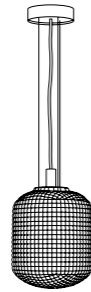

Hidden Light
→ 084—85



Hidden Light Floor Lamp
→ 108—109

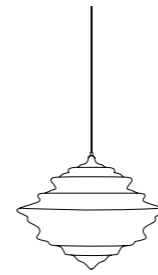

Neverending Glory Metropolitan Opera M
→ 012—17

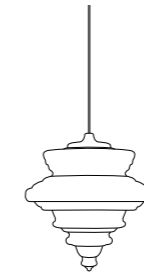

Neverending Glory La Scala M
→ 012—17

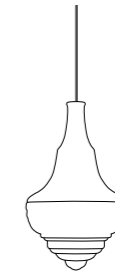

Neverending Glory Prague Estates Theater M
→ 012—17

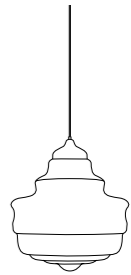

Neverending Glory Palais Garnier M
→ 012—17

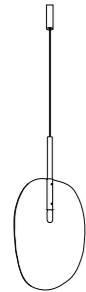

Lollipop Glass A
→ 064—65

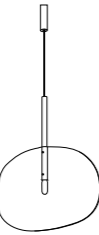

Lollipop Glass C
→ 064—65

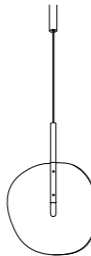

Lollipop Glass B
→ 064—65

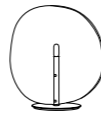

Lollipop Table Lamp Glass B
→ 124—125

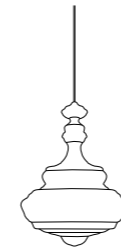

Neverending Glory Bolshoi Theater S
→ 012—17

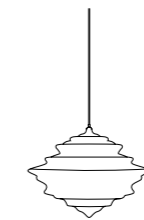

Neverending Glory Metropolitan Opera S
→ 012—17

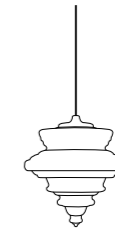

Neverending Glory La Scala S
→ 012—17

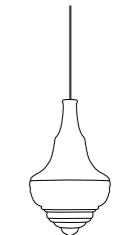

Neverending Glory Prague Estates Theater S
→ 012—17

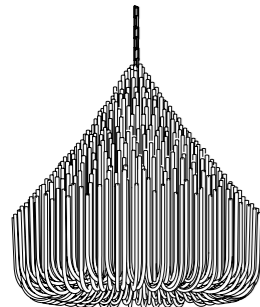

Ludwig L
→ 054—55

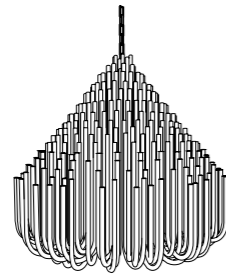

Ludwig S
→ 054—55

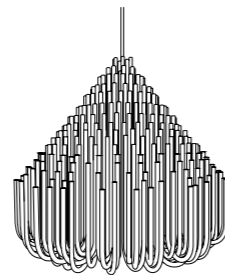

Ludwig S on Metal Rod
→ 054—55

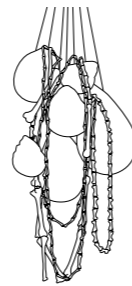

Memento Mori
→ 066—67

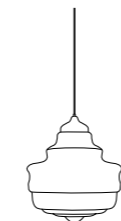

Neverending Glory Palais Garnier S
→ 012—17



Neverending Glory Wall Sconce
→ 100

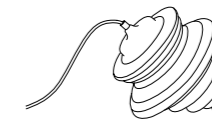

Neverending Glory La Scala Floor Lamp
→ 110—111



Neverending Glory La Scala Table Lamp
→ 126—127



Moulds S
→ 068—69

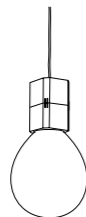

Moulds L
→ 068—69

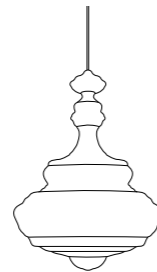

Neverending Glory Bolshoi Theater L
→ 012—17

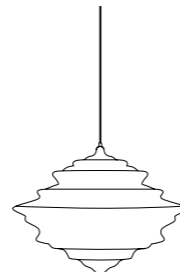

Neverending Glory Metropolitan Opera L
→ 012—17



Plisse S
→ 056—57

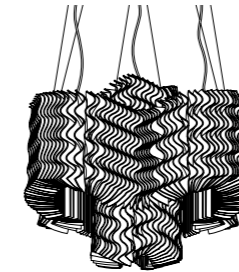

Plisse L
→ 056—57

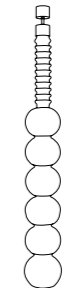

Praha Single L
→ 086—87

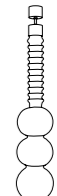

Praha Single S
→ 086—87

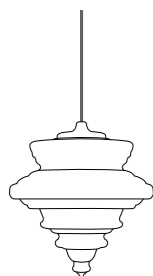

Neverending Glory La Scala L
→ 012—17

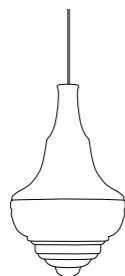

Neverending Glory Prague Estates Theater L
→ 012—17

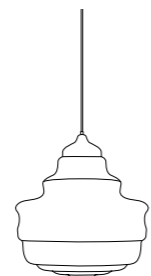

Neverending Glory Palais Garnier L
→ 012—17

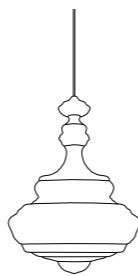

Neverending Glory Bolshoi Theater M
→ 012—17

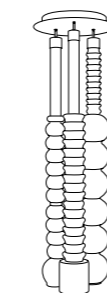

Praha Cluster of 3 L
→ 086—87

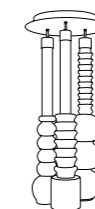

Praha Cluster of 3 S
→ 086—87

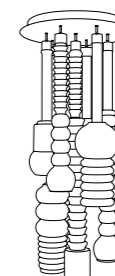

Praha Cluster of 7
→ 086—87

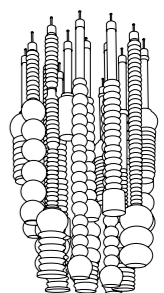

Praha Cluster of 22
→ 086—87



Press
→ 42—43



Press Iced
→ 42—43



Press Floor Lamp S
→ 112—113



Press
→ 112—113



Yakisugi Single L
→ 62—63

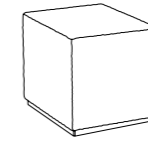

Yakisugi Table Lamp
→ 130—131

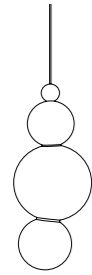

Spacey Eclipse
→ 30—33

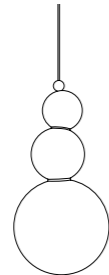

Spacey Supermoon
→ 30—33



Spacey Table Lamp Lunar
→ 128—129

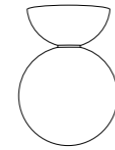

Spacey Ceiling Lamp Moon
→ 102—103

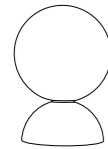

Spacey Floor Lamp Midnight Sun
→ 114

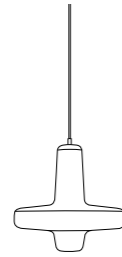

Spin M
→ 88—89



Spin Wall Sconce S
→ 101

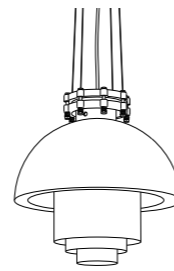

Transmission
→ 90—91

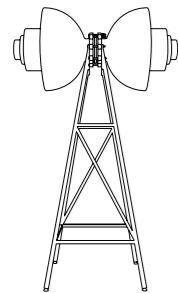

Transmission
→ 115

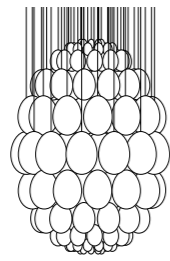

Uovo S
→ 58—59

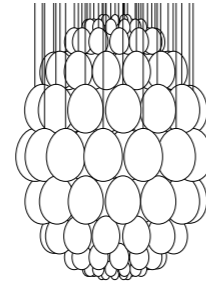

Uovo L
→ 58—59

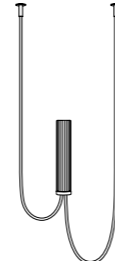

Upside Down Solo
→ 34—37

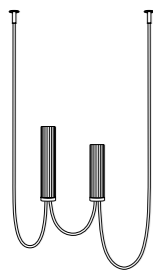

Upside Down Twins
→ 34—37

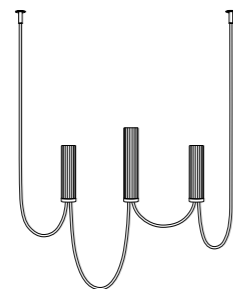

Upside Down Trinity
→ 34—37

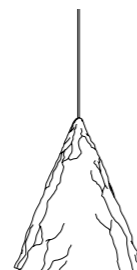

Volcano
→ 60—61

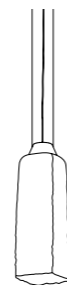

Yakisugi Single S
→ 62—63

Pendants & Chandeliers



Neverending Glory

Czech talents Jan Plecháč and Henry Wielgus modelled the Neverending Glory collection after the iconic chandeliers hung in five of the world's most illustrious stages; Moscow's Bolshoi Theatre, the Estates Theatre in Prague, the Palais Garnier in Paris, Milan's La Scala and the Metropolitan Opera House in New York City. The collection transports the grandiosity

of the chandeliers into a contemporary form and scale in order to fit modern spaces. Elegant, clean and refined, the Neverending Glory offers a collection of pendants, floor lamps, table lamps and wall sconces. It provides limitless options to shape a space and redefine it with new purpose and feeling.

Neverending Glory Pendants
(From Left to Right)
Bolshoi Theater
La Scala
Palais Garnier
Metropolitan Opera
Prague Estates Theater
—
Design
Jan Plecháč and Henry Wielgus







Bolshoi Theater / La Scala / Palais Garnier / Metropolitan Opera / Prague Estates Theater L



Bolshoi Theater / La Scala / Palais Garnier / Metropolitan Opera / Prague Estates Theater M



Bolshoi Theater / La Scala / Palais Garnier / Metropolitan Opera / Prague Estates Theater S





Crystal Rock

The Crystal Rock collection was designed by Arik Levy, whose work is exhibited in museums and galleries worldwide. Each piece of the collection is sharply cut and polished to form a contemporary geometric design. The glass has the perfect alignment of density, transparency and acute edges, casting a myriad of gentle reflections throughout the piece.

The collection consists of pendants in three sizes and a table lamp – making it a flexible tool for creating a bespoke space with its own unique journey. Because the collection's spacial design concept is so versatile, it can be displayed alone or in clusters over dining tables, staircases or hospitality entrances, elevating guests from a fixed locale to a memorable, immersive experience.

Crystal Rock Pendants
—
Design
Arik Levy

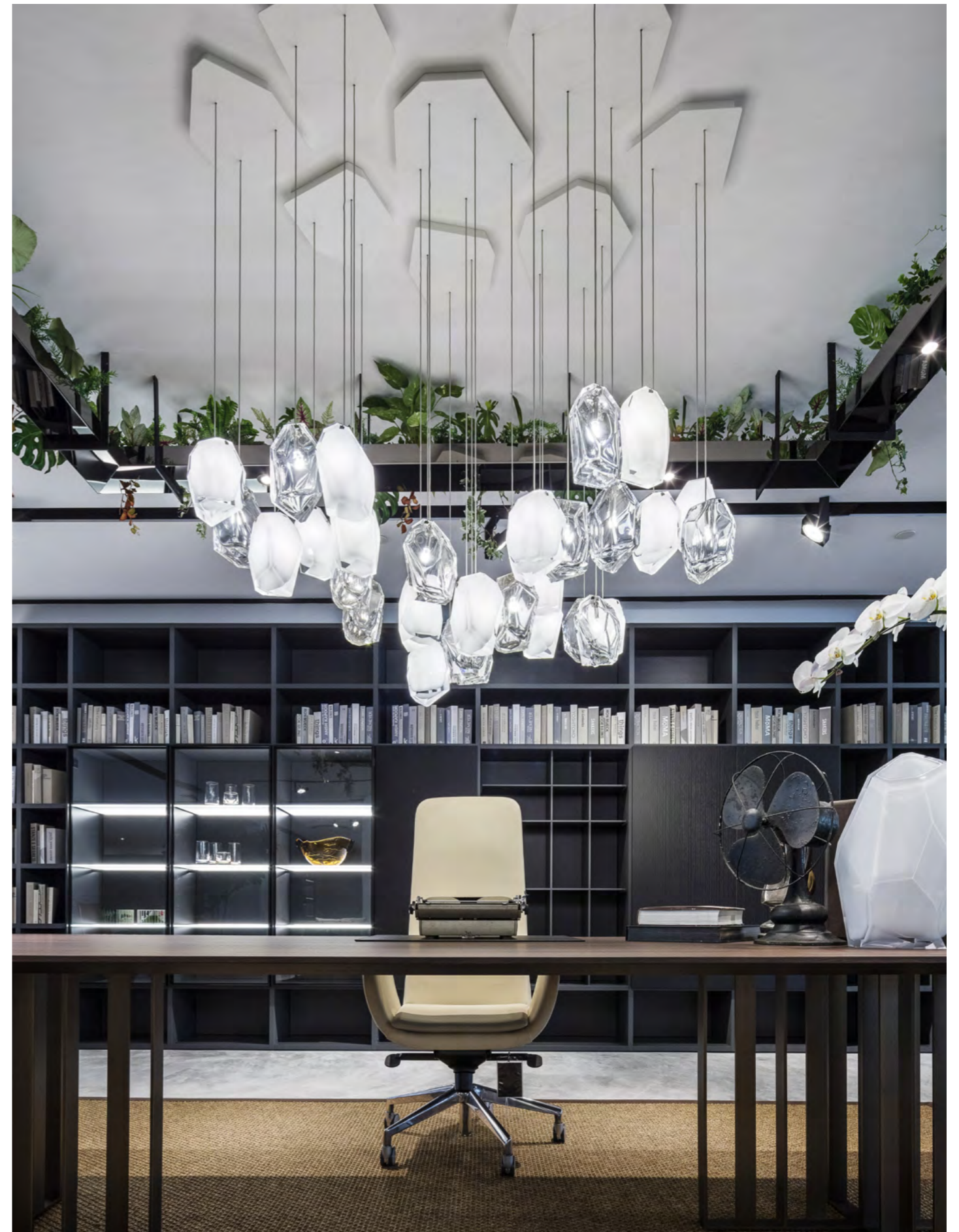





Clear 01



Opal 02



Light Amber 04



Blue 08



Clear 01



Opal 02



Light Amber 04



Blue 08



Red 07



Mix Clear 71



Mix Opal 72



Mix Light Amber 74



Red 07



Mix Clear 71



Mix Opal 72



Mix Light Amber 74



Mix Warm 76



Mix Icy 73



Mix Blue 78



Mix Base 77



Mix Red 75



Mix Blue 78



Mix Multi 79

Crystal Rock
Clusters 3 and 5
—
Color Variants

Cipher

The Cipher collection was created by the world-famous Yabu Pushelberg design firm. They are known for their attention to detail and uninhibited exploration into artistry. True to form, the Cipher collection blends bold contemporary design with meticulous craftsmanship.

Each glass piece is decorated with a system of precise cuts and engravings.

Light travels only between the connection points, bringing a concert of reflections and shadows into the surrounding space. The collection offers two pendant shapes, table lamps in two sizes, a floor lamp and a wall sconce. Showcased alone or grouped together, the pieces offer a variety of arrangements to transform any modern interior into an unmatched experience.

Cipher
(From Left to Right)
Cipher Horizontal L, S
—
Design
Yabu Pushelberg







The Cipher collection features slender lights, shaped like sunbursts and elongated capsules. Each of the handblown glass bulbs is then meticulously hand-etched with clean-cut vertical lines by some of the most skilled artisans in the world. The individual crystal tubes erupt from champagne-gold polished brass fittings at the centre of the lights. Within

the bulbs, light glows around the etched lines of the glass, creating luminescent silhouettes. Hidden LED sources within the brass connection points soften the bulbs' illumination as the light travels down the etched lines. As the light hits the finely etched lines, the longer cylindrical pieces project intricate patterns onto the walls and surrounding surfaces.

Cipher
(From Left to Right)
Cipher Star
Cipher Vertical S, L
—
Design
Yabu Pushelberg



Spacey

The Spacey collection was authored by Lukáš Novák, who uses glass as a medium to transmit emotions and stories. The collection's glass bodies mimic the universe. And as we look up to the heavens and marvel, we do so too when looking at the stunning depth of these lighting objects. The author uses a centuries-forgotten technique called Lithyalin

to create the glass spheres. Each sphere has its own distinct markings within its sleek, marble-like finish. Spacey offers pendants in two sizes and a table lamp. The pendants hang perfectly in residential spaces where guests are bound to look into the small microcosm and – as if they were lifting their eyes to the night sky – feel wonder.

Spacey Pendants
(From Left to Right)
Spacey Supermoon
Spacey Eclipse
—
Design
Lukáš Novák







Upside Down

Designer Boris Klimek is author of the Upside Down lighting series. For years, Klimek has been interested in incorporating the simplicity and rawness of loosely hanging cables. Yet, he still wanted to capture the grandiosity of chandeliers, which he found in the curves of the free-hanging wires. In achieving his vision, Klimek's design for the

Upside Down series organically juxtaposes beautifully contrasting elements: raw design with elegance, magnificence with ease. The series lifts a space to one of quiet grandeur, providing a gentle, yet stunning, experience. The Upside Down lighting can be hung independently, or combined with additional lighting bodies.

Upside Down Pendants
 (From Left to Right)
 Solo Pendant
 Twins Pendant
 Trinity Pendant
 —
 Design
 Boris Klimek







Duna

Duna was created by renowned studio Zaha Hadid Design. The collection's design language is deliberately fluid and organic, modelled after naturally occurring dune formations. Glass is blown into metal moulds to create a distinctively asymmetrical shape, and finished with a ripple effect that allows light to tease throughout the pieces' curves. The Duna collection consists of

a pendant and wall sconce, which can be showcased in clusters or as a lone focal point. The wall sconce is especially beloved in a hallway or bedroom, transforming a conventional layout to an extraordinary spacial design. The collection's stunning, yet unapologetic, shapes can elevate any setting to a space that demands to be seen and remembered.

Duna Pendant
—
Design
Zaha Hadid Design







Press

The Press Lamp collection was created by the world-renowned, Tokyo-based Nendo design studio. Following the minimalistic approach to contemporary Japanese design, Press Lamp offers pieces that are not only stunning in their simplicity, but subtly play with the space between the design. The angles of the pinched surface savour the light, containing it within the cylindrical form in order to maintain

a gentle glow. Because the collection has an unwaveringly clean and thoughtful design language, it is exquisite in clusters, reshaping a space with breathtaking softness and vulnerability. The ICE storyline adds a greater depth to the space between the design, while with Press, the light is hushed and indistinct, uplifting guests in an ambience of warmth and awe.

Press Pendants
 (From Left to Right)
 Press Smoke
 Press Clear
 Press Iced
 —
 Design
 Nendo





And Why Not!

The “And Why Not!” light sculpture was aptly named by its creator René Roubíček, referring to his lifelong experimentation and exploration into form and composition within glass. Roubíček is a Czech icon in the field of glass design. His work continues to be showcased in many galleries worldwide.

“And Why Not!” was created as a dynamic, spacial sculpture that remains timeless and

youthful – even after 20+ years. Perhaps it is because of the way light glides sleekly through the polished cylinders of the sculpture when lit. The lighting becomes a colossal, albeit refined, fixture and a distinctive experience.

“And Why Not!” fits perfectly in a conference hall, uplifting a four-walled room into a space of stature and prominence.

And Why Not! Chandelier
—
Design
René Roubíček

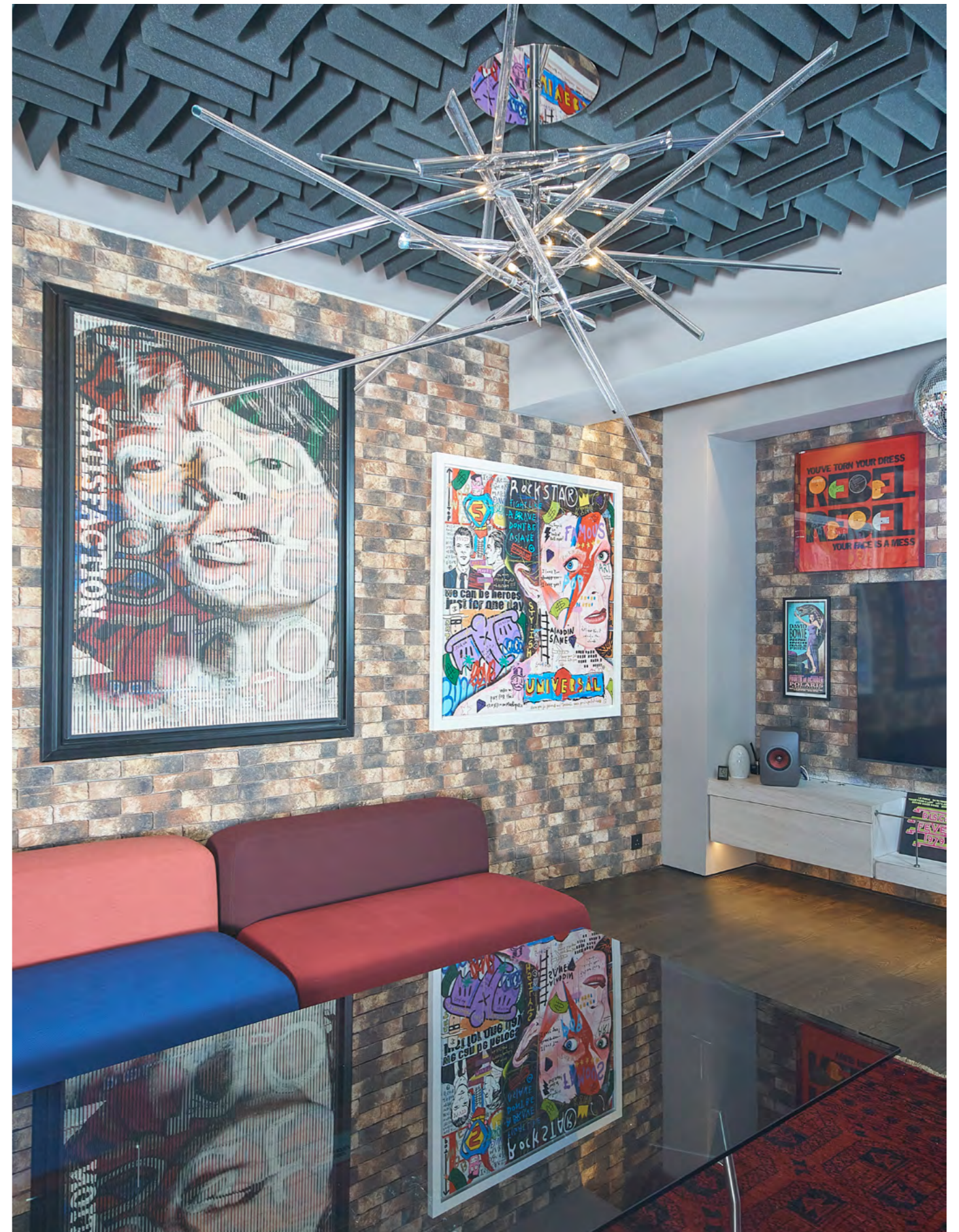



Droplets

The Droplets light sculpture was created by Czech designers Jan Plecháč and Henry Wielgus, who are well-known for their contribution to the industry. The sculpture's design is inspired by nature, particularly in the way that gravity shapes a single drop of water when falling. When lit, the Droplets sculpture creates a cascade of light, shimmering over

and around guests. It is a transformative moment that is sure to resonate with anyone who experiences it.

Due to the scale and grandeur of the lighting sculpture, it is intended for high ceilings or staircases. The sculpture is not only *in* the room, but becomes the central focus of the room, uplifting the space to match its splendour.

Droplets Sculpture
—
Design
Jan Plecháč & Henry Wielgus





Eve

The Eve pendant lighting was created by the world-renowned Zaha Hadid Design studio. The studio addresses contemporary design from a distinct perspective by focusing on the latest technological and material advancements. The Eve pendant itself is influenced by Hadid's own design approach, emphasizing organic forms and fluid shapes. The Eve pendant lighting is fully composed

of fifteen glass pieces, joined together in unison to create a stunning, harmonious shape. Each of the glass bodies are suspended at different heights, floating effortlessly above, and creating a playful tug-of-war between light and shadow. Over a dining table, the Eve pendant lighting can uplift any dinner ambience to one of seamless sophistication.

Eve Pendant
—
Design
Zaha Hadid Design





Glitters

The Glitters collection was created by Czech designer and architect Gabriela Náhliková, who aims to free her design language from customary perspectives by applying a fresh approach. The Glitters collection builds on the author's unconventional style by creating "pleats" in the glass in order to play with reflections and shadows. When lit, the light slides in and out

of the angles, creating an array of lights across the room.

Glitters offers a pendant in single, double and triple sizes, table lamp and wall sconce. Due to its simple elegance, each piece of the Glitters collection can create an alluring ambience in a spa setting or bedroom, elevating each space with the feeling of romance and glamour.

Glitters Pendants
(From Left to Right)
Glitters Single
Glitters Double
—
Design
Gabriela Náhliková





Globe Metro

Cyril Dunděra, author of Globe Metro, is a Prague-based designer who has gained a place in the spotlight for his experimental glass work. Globe Metro takes on the role of a shapeshifter, and its light creates a puzzle in the interior of the glass form. Each side of the glass pendant offers a different shape. No matter where it is placed, guests have a different spacial

experience when looking at it from different angles. Globe Metro was informed by Prague's metro tiles, which have a similar hemisphere in their center. Globe Metro's stunningly distinct iris colour accentuates the clean concave and convex shapes of the entire form. The lighting is suitable for modern interiors that call out for experimentation and rebellion.

Globe Metro Pendants
 (From Left to Right)
 Globe Metro Iris
 Globe Metro Rainbow Blue
 —
 Design
 Cyril Dunděra





Ludwig

The Ludwig collection was designed by Maurizio Galante, one of the world's most reputable haute couture designers. Ludwig balances between the rational and irrational, vis-a-vis between mathematical calculations for the tube design and an emotional pull toward the shape and luminance. The collection is inspired by the chandelier in the Ludwig Palace, connecting neoclassical

form with smooth, contemporary contours. Ludwig creates a tension between tradition and modernity. It plays on a timeless structure by using glass tubes to give the shape a modern twist. Whether in the smaller or larger size, the light is not meant to adorn a room, but to be the focus of the space, giving guests an undeniably breathtaking spacial experience they'll want to share.

Ludwig Chandelier
—
Design
Maurizio Galante





Plisse

The Plisse collection was created by Maurizio Galante, one of the world's most respected haute couture fashion designers. His works can be defined as a balance between tradition and innovation, pace and modernism, sophistication and discretion.

The Plisse lighting collection is fittingly named after the plissé cotton fabric, which is treated to give it

a puckered appearance. The collection comes in two sizes and shapes, both pieces offering the softness of the fabric, spun into smooth and clear glass.

Characteristic of the author, the Plisse chandelier is a perfect balance between clean lines and uninhibited caprice, making it a versatile piece that can provide a distinct experience for every space it hangs in.

Plisse Chandeliers
(From Left to Right)
Plisse Small
Plisse Large
—
Design
Maurizio Galante



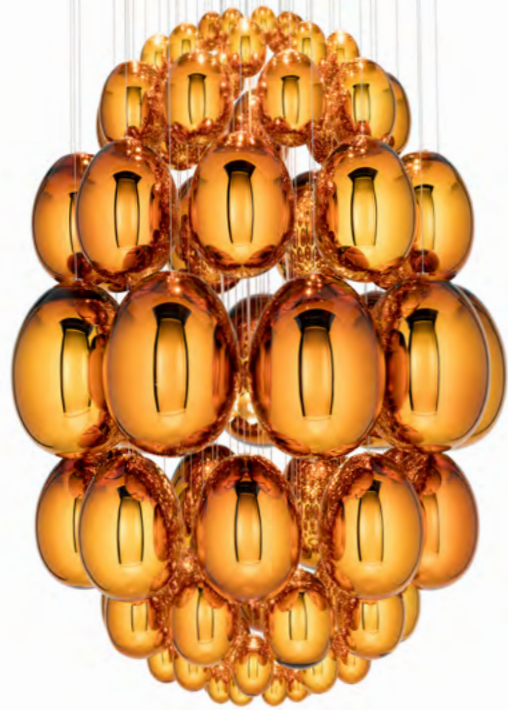

Uovo

The Uovo collection was created by leading Czech designer Rony Plesl, whose limited editions of glassware are for example owned by Prince Albert of Monaco and French actress Juliette Binoche.

Plesl's artistry shines through in his Uovo collection, where each light sculpture is composed of singular components of egg shapes. The "eggs" work in harmony to create one

sublime, synchronous form. When lit, each glass body behaves as a mirror, delicately bouncing the lights on and off of their rounded curves.

Guests immediately fall in love with the Uovo collection, because its magnificence uplifts the atmosphere of the space. The collection is offered in two sizes, and can be showcased in clusters or as a solitary spatial experience.

Uovo Sculptures
(From Left to Right)
Uovo Small
Uovo Large
—
Design
Rony Plesl

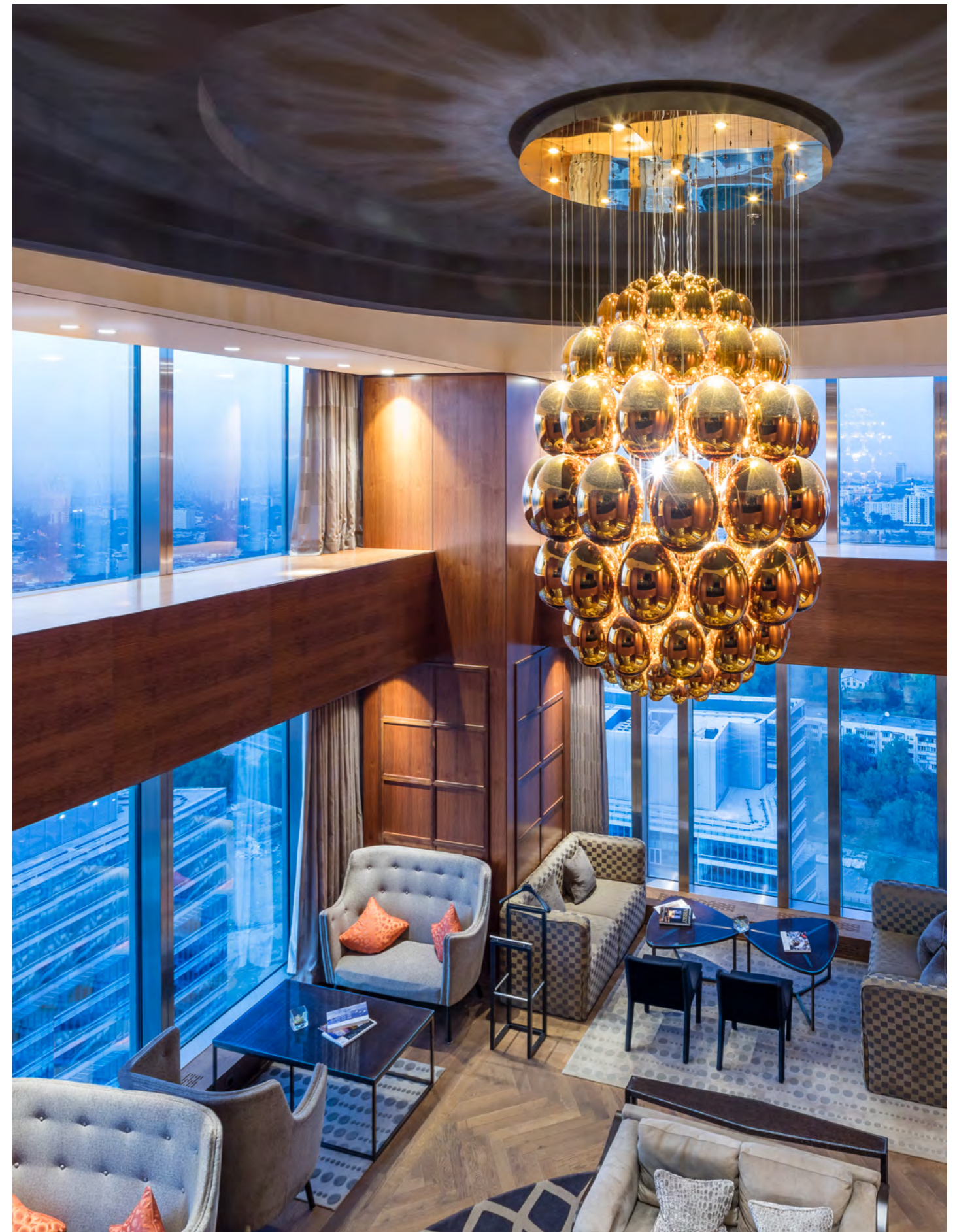



Volcano

Czech designer and Art Director of Lasvit Maxim Velčovský is the author of the Volcano pendant. Velčovský is well-known for his uninhibited and captivating designs, exhibiting in museums all over Europe.

The shape of the Volcano pendant was influenced by the non-active volcanic mountains towering throughout the Czech countryside – geological remnants of days passed. The glass on the

Volcano pendant mimics the rock formations created by lava. When lit, the light inside glows warmly, showcasing the meticulous, yet primal, detailing on the glass.

The pendants may be grouped in clusters or hung alone over a table for a unique dining atmosphere. The experience lifts guests to a temporal space of rugged nature, all contained within a four-walled room.

Volcano Pendants
(From Left to Right)
Volcano Clear
Volcano Smoke
—
Design
Maxim Velčovský





Yakisugi

Renowned Japanese designer Kengo Kuma is the author of the Yakisugi collection. Yakisugi confronts two opposing materials – wood and glass. Molten glass is poured into a wooden mould, which catches fire from the inside, capturing the wooden texture into the glass. This technique is reminiscent of the traditional Yakisugi approach, where wood siding is charred by fire to preserve it.

Yakisugi offers a floor lamp and pendants that can be showcased in clusters or alone for a clean, minimalistic feel. Every special design choice is unique, because a wooden mould is used only once for each lighting object. So, each piece has a distinct texture. Yakisugi uplifts any space into one of tranquillity, in which nature lives harmoniously with modernity.

Yakisugi Pendants
(From Left to Right)
Yakisugi Single Small
Yakisugi Single Large
—
Design
Kengo Kuma

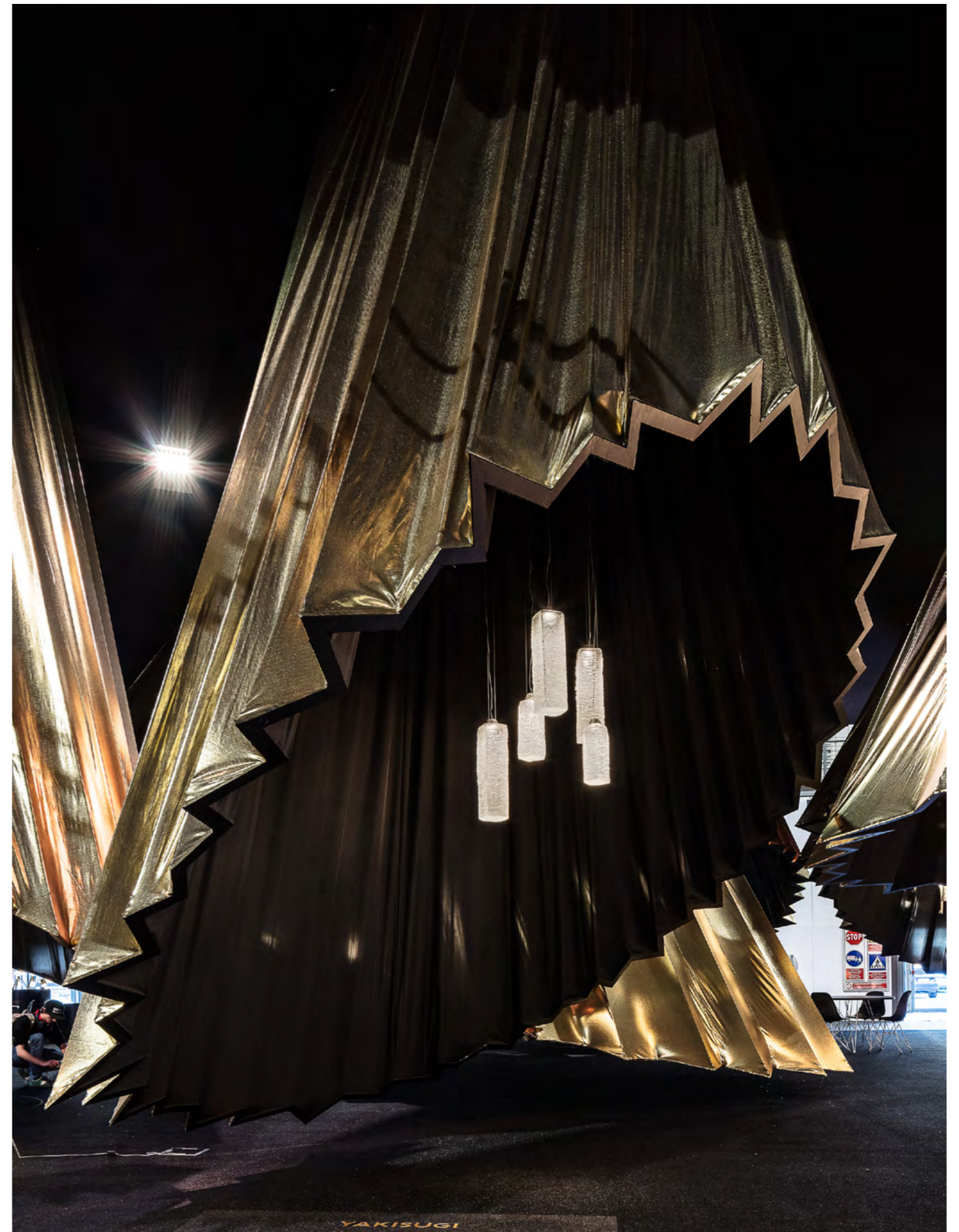



Lollipop

The Lollipop collection was designed by Boris Klimek, who has received numerous prizes for his work. His designs are conceptual, often telling stories through poetry, playfulness and fantasy. This design approach rings true for Lollipop, where each lighting object is a formless glass plate, toying with the colour and structure within. The collection offers pendant lighting

in three shapes and five colours, and a table lamp also in five colours – the possibilities for redefining a room are expansive. Due to the playful nature of the lighting, each piece or cluster fits perfectly in a child's bedroom, brightening up the space with joy and imagination. Lollipop also brings a splash of colour to open interiors to invite a little whimsy and fun.

Lollipop Pendants
 (From Left to Right)
 Lollipop Glass A
 Lollipop Glass B
 Lollipop Glass C
 Lollipop Glass A
 —
 Design
 Boris Klimek





Memento Mori

Designer and Art Director of Lasvit Maxim Velčovský created the Memento Mori light sculpture. Velčovský is known for his experimentation and exploration into design, and rebellion against convention. Memento Mori creates a new context for the well-known adage, so that it isn't solely a reflection of mortality, but rather of perpetuity, as craft is passed on from generation to generation.

The sculpture consists of hundreds of bones, where the author combines different production approaches; some bones are created in a press technique, whereas others are modelled by the most skilled craftsmen in the Czech Republic. Memento Mori is distinct in its concept, artistry and vision. It challenges guests to reflect upon it, and perhaps even upon existence as a whole.

Memento Mori Sculpture
—
Design
Maxim Velčovský





Moulds

Leading Czech designers Jan Plecháč and Henry Wielgus created the Moulds collection. The collection offers pendant lighting in two sizes. The glass itself forms a delicate bubble, rising out of the wooden mount as if it were blown with air. The LED light is set directly within the mount, casting a glimmer that is reminiscent of heat inside of

a glassmaker's kiln. Because Moulds straddles a balance between solid construction and elegant fragility, it fits perfectly in industrial-styled interiors. It also fits in wooden interiors, such as ski lodges, where the radiating glow inside the lighting lifts guests to a place of warmth and comfort, as if next to a crackling fireplace.

Moulds Pendants
 (From Left to Right)
 Moulds Large
 Moulds Small
 —
 Design
 Jan Plecháč & Henry Wielgus





Candy

The Candy collection was created by the world-renowned Estudio Campana. True to their colourful design language, the Campana Brothers were immediately inspired when they visited the Lasvit premises. They described the melting colours of glass in the glassworks as a vivid candy factory, and wanted to create a collection in the spirit of what they saw – a Candy collection.

Candy offers two forms of chandeliers. Each eye-catching piece is decorated with individual strips of glass, meticulously fused to the opal component. When lit, the glow accentuates the glass strips, uplifting any space with a light-hearted, joyous aura. The collection fits best in a bright hospitality entrance or sunny residential space, giving a playful touch to a well-lit atmosphere.

Candy Chandeliers
(From Left to Right)
Candy Ring
Candy Sphere
—
Design
Campana Brothers

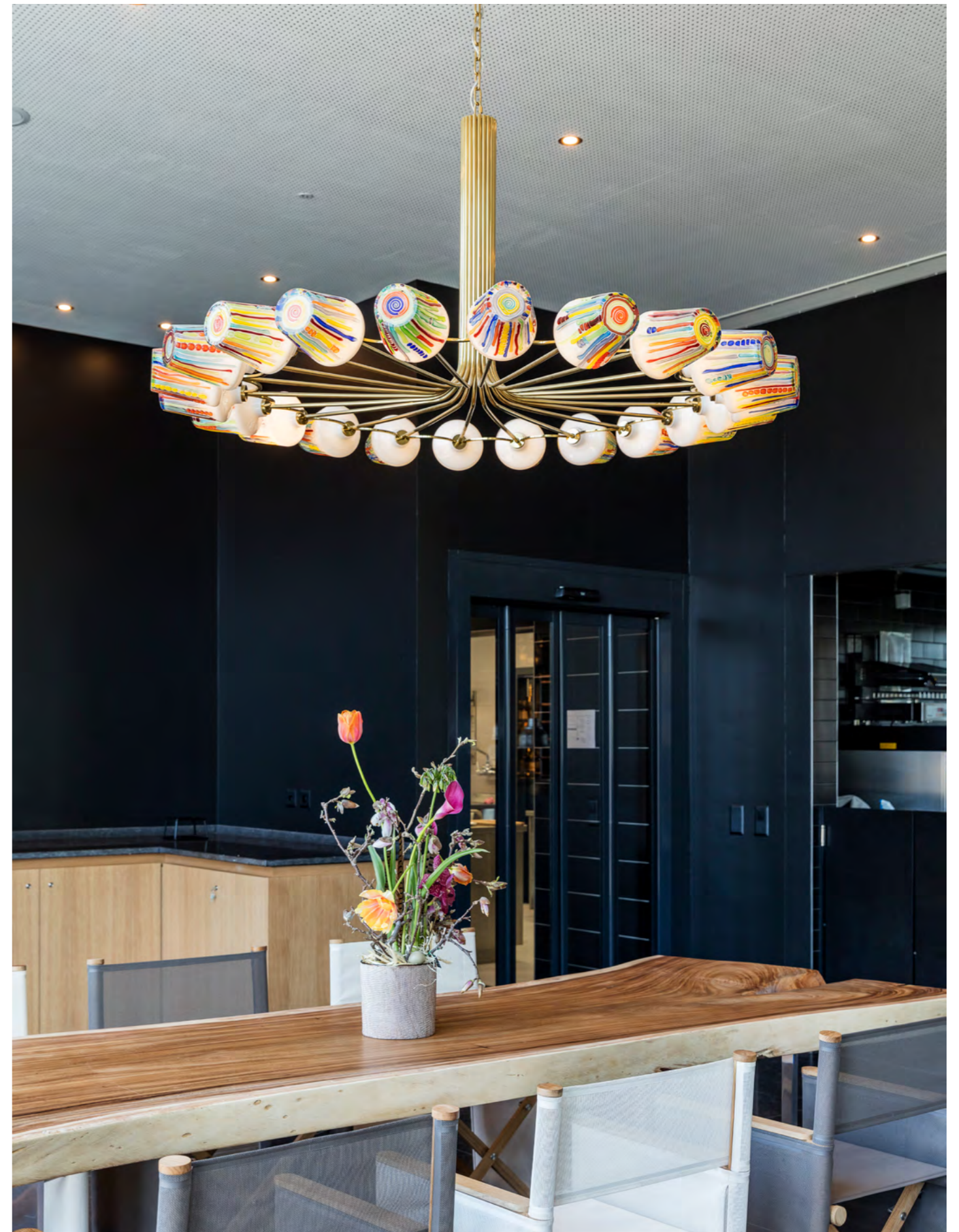



Empress

The Empress collection is designed by Jakub Berdych, co-founder of Qubus Design Studio. The collection is informed by traditional Theresian chandeliers, where the classical aristocratic lighting structures were made at a time of extreme perfectionism.

The Empress chandeliers translate the Theresian fixtures within the scope of Berdych's own design language, in that the

trimmings are incomplete – stopped prior to the final cutting and polishing. He contrasts the traditional fastidiousness of the past era with his own brutal vision, creating a splendidous take on the merger of tradition and modernity. The collection has chandeliers in two sizes. Due to their grandeur, they can uplift a formal setting to an ambience of pomp and nobility.

Empress Chandeliers
 (From Left to Right)
 Empress Low /Violet
 Empress Low /Copper
 —
 Design
 Jakub Berdych



Facet

Author of the Facet collection Moritz Waldemeyer is internationally known for his forward-thinking designs. Given Waldemeyer's aptitude for exploration, Facet fuses traditional forms with modern approaches, where references to classic chandeliers find their way into new design. Each component of the Facet chandelier can be a product itself, in that each glass body is a perfect profile of

a miniature chandelier. Every component has a unique, organic structure, reflecting the soul of the entire chandelier. The collection comes in clusters of seventeen, nineteen and thirty-seven, and can be hung in an open entrance or over a table in a dining hall. Each Facet chandelier can redefine a space with classical grandeur, while simultaneously uplifting it with modern sophistication.

Facet Sculptures
(From Left to Right)
Facet Cluster of 7
Facet Cluster of 19
Facet Cluster of 37
—
Design
Moritz Waldemeyer





Frozen

Leading Czech designer and Lasvit Art Director Maxim Velčovský is the creator of the Frozen collection. His idea was to use glass to make a stunning design that truly looks liquid. The molten glass is poured over a metal form in layers to expose its natural properties, and ultimately appear to be frozen liquid.

The collection offers two pendants. Revered for its imperfection, every

Frozen pendant has its own unique shape and texture since each is made per request. The collection is suitable in clusters or alone in open-space kitchens or over dining tables. Inspired by the organic formation of ice, the collection brings a special spacial experience to guests, akin to exploring the unique wonders of nature.

Frozen Pendants
(From Left to Right)
Frozen Large
Frozen Small
—
Design
Maxim Velčovský





Fungo

The Fungo collection was created by internationally respected Estudio Campana, which is famous for its renowned furniture design. The Campana Brothers' captivating work often glorifies common materials, incorporating reinvention and transformation into their designs. The Fungo chandelier exemplifies their distinct artistry and exploration through an intriguing topic – mushrooms.

The Fungo chandelier unites glassmaking craftsmanship with woodcraft techniques. The outcome is a sublime symbiosis between the chandelier's sturdy wooden form and the glass bodies that emerge from the frame as spores. The Fungo chandelier is suitable for minimalistic Scandinavian design, uplifting the starkness of a bare room with the temporal essence of nature.

Fungo Chandeliers
 (From Left to Right)
 Fungo Large
 Fungo Small
 —
 Design
 Campana Brothers





Galaxy Luminia

Creator of Galaxy Luminia, Bořek Šípek, was a renowned Czech architect and designer. His legacy lives on in the permanent collections of many museums worldwide and through his contribution to the Prague Castle as the Court Architect, appointed by Václav Havel.

The Galaxy Luminia sculpture has an intriguing, unique spacial

design, consisting of a range of separate decorative components to create a united, celestial form. When lit, the light shines through the sculpture's interior spherical glass bodies, seeming almost as orbs floating in space. The Galaxy Luminia light sculpture uplifts a residential space to one of hidden stories and playful imagination.

Galaxy Luminia
Quadrax Lenitas
—
Design
Bořek Šípek





Growing Vases

Growing Vases was created by the Tokyo-based Nendo design studio, which has received numerous international awards for its fresh perspective on design. The Growing Vases light sculpture radiates the beauty of nature in an exquisite array of abstract flowers.

Each glass bulb is blown from a thin steel pipe. However, instead of

separating the glass from the pipe, it is fused together, as if frozen in that moment. More pipes are added and lacquered. They become flowers and branches sprouting from their amorphous vases. When lit, the chandelier gives off an ephemeral halo, lifting the spacial experience to one reminiscent of a lush meadow filled with wildflowers.

Growing Vases Sculpture
—
Design
Nendo





Hidden Light

Leading Czech designers Henry Wielgus and Jan Plecháč explored the human psyche when creating the vision for Hidden Light. They compared the essence of light to humanity's inner spark; a brightness that can free us from the cage of society's expectations. They materialized this metaphor into a pendant lighting and a floor lamp.

Large glass pieces were blown into a cage-like metal form, yielding a tremendous, yet elaborate, mass of glass blocks to build a solid body. When turned on, Hidden Light's immense glass cage emits light outward, offering a humbling spacial experience in which guests can reflect on their own unique radiance.

Hidden Light Pendant
—
Design
Jan Plecháč & Henry Wielgus





Praha

The Praha Chandelier was created by renowned Czech designer Stanislav Libenský, whose teaching and notoriety has helped form the current generation of glass artists in the Czech Republic and abroad.

The Praha Chandelier was designed for Hotel Praha, a colossal architectural endeavour constructed in the 1980's. Despite efforts to preserve it as a cultural monument, it was later torn down.

The Praha Chandelier is amongst the few remaining artefacts from the building.

Because the glass of the Praha Chandelier is created with varying thicknesses, an array of diverse shadows glide between the glass bodies and throughout the surrounding interior when lit. The chandelier gives an intriguing spacial experience by uplifting the room with a kaleidoscopic effect.

Praha Pendants
 (From Left to Right)
 Praha Short
 Praha Long
 Praha Cluster of 3 Long
 Praha Cluster of 7
 Praha Cluster of 22
 —
 Design
 Stanislav Libenský





Spin

Lucie Koldová is the author of the Spin lighting. She spent a year at world-renowned designer Erik Levy's studio before opening her own studio in Paris. The Spin lighting's sleek design is based on a clean rotational shape, reminiscent of the precision of a child's spinning top.

When lit, the light reflects against the disc-shaped glass body, casting elliptical shadows against the surrounding interior. The Spin lighting can be hung as a single focal point or in clusters over a dining table in an industrial setting to accentuate clean lines and stark beauty.

Spin Pendant Medium
—
Design
Lucie Koldová

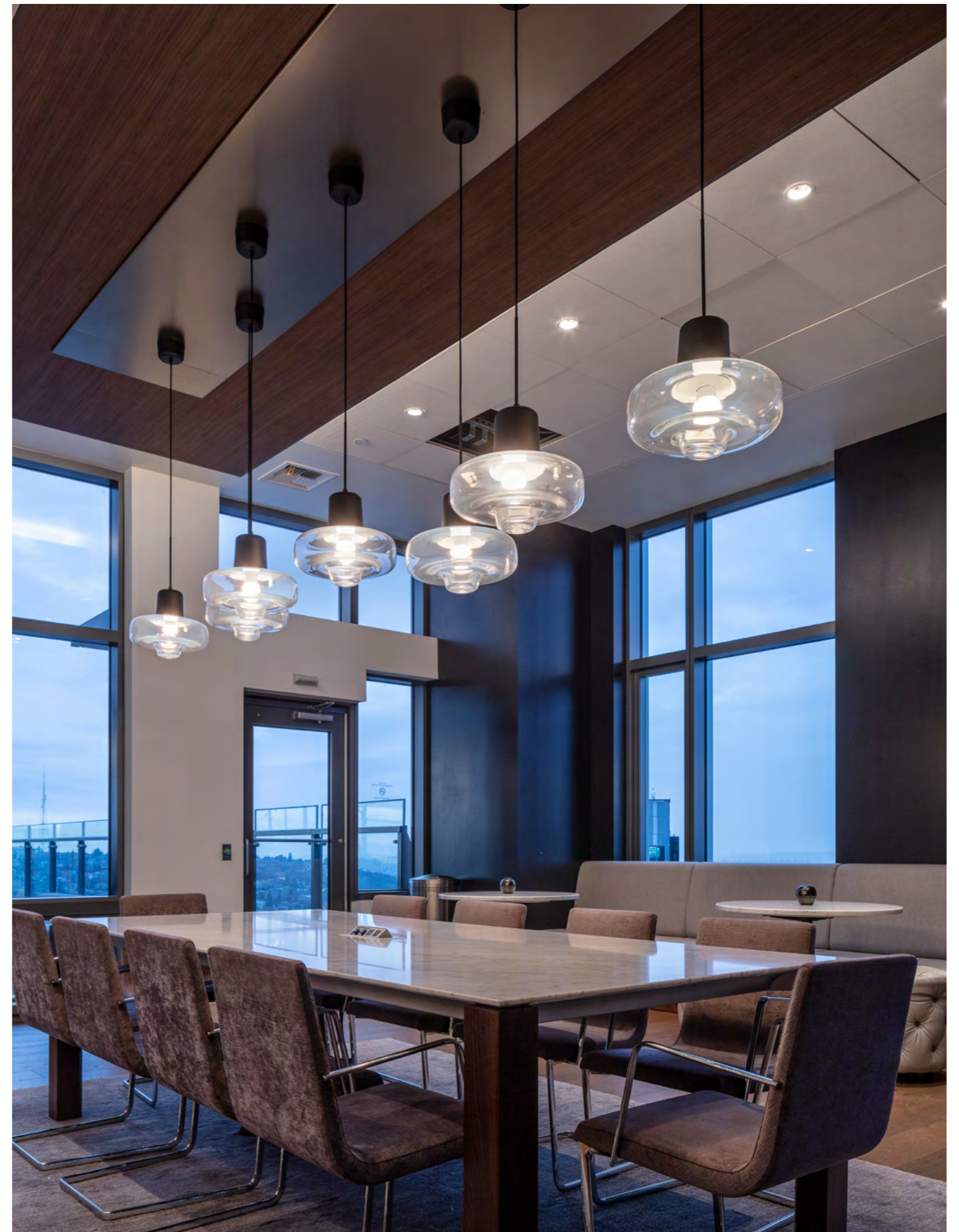



Transmission

The Transmission collection was created by Studio deFORM, who continuously look to broaden their design approaches in interesting and compelling ways. The Transmission collection was formed through experimentation with Simax borosilicate glass and manufactured in collaboration with Kavalierglass.

The nearly hemispherical shades of glass frame the luminaire, allowing

surprising shadows and reflections to slide over the curves. The clean, rounded glass is joined together by hard steel, giving the delicate form an elegant durability. The collection includes a light sculpture and a floor lamp. Each lighting sculpture fits well alone or along the ceiling of a minimalist interior design, uplifting the space with a distinctly stark, yet charismatic, spacial experience.

Transmission Pendant
—
Design
deFORM





Wall & Ceiling Lamps

Cipher

The Cipher collection was created by the world-famous Yabu Pushelberg design firm. They are known for their attention to detail and uninhibited exploration into artistry. True to form, the Cipher collection blends bold contemporary design with meticulous craftsmanship.

Each glass piece is decorated with a system of precise cuts and engravings.

Light travels only between the connection points, bringing a concert of reflections and shadows into the surrounding space. The collection offers two pendant shapes, table lamps in two sizes, a floor lamp and a wall sconce. Showcased alone or grouped together, the pieces offer a variety of arrangements to transform any modern interior into an unmatched experience.



Cipher Wall Sconce
—
Design
Yabu Pushelberg



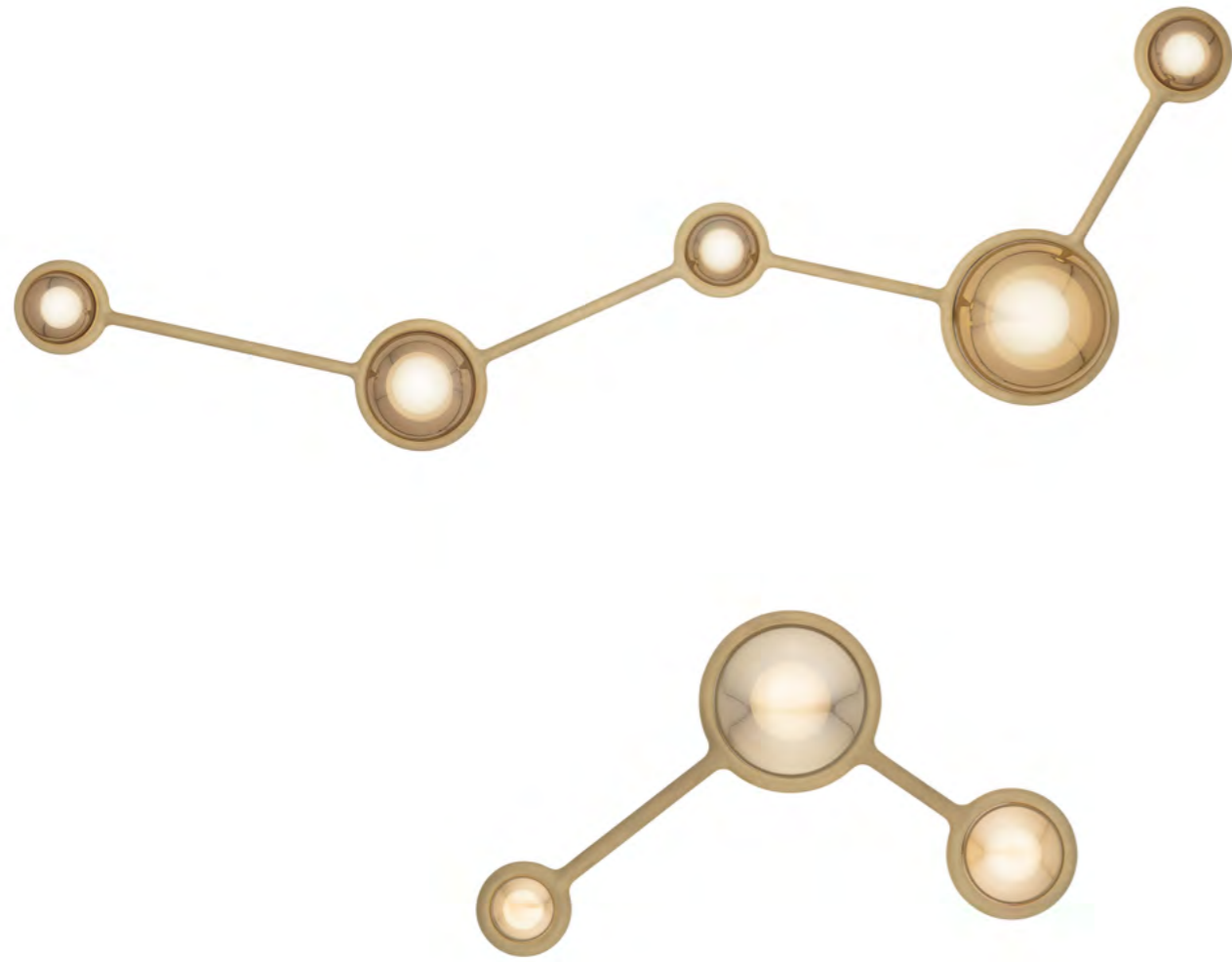

Constellation

Constellation was designed by American architect and designer David Rockwell. He is founder of the Rockwell Group, a cross-disciplinary architecture and design firm based in New York City. The Constellation collection is housed in New York City's Grand Central Terminal, uplifting visitors from their daily commute

to an ethereal spacial experience. Constellation offers a ceiling lamp, a wall sconce and floor lamp representing Cassiopeia, Orion's Belt and Polaris respectively. Each piece is modular and offered in bespoke configurations. Wherever displayed, the light becomes the focal point of the space, evoking awe and wonder.

Constellation
 (From Top to Bottom)
 Constellation Cassiopeia Ceiling Lamp
 Constellation Tri Star Wall Sconce
 —
 Design
 David Rockwell



Duna



Duna was created by renowned studio Zaha Hadid Design. The collection's design language is deliberately fluid and organic, modelled after naturally occurring dune formations. Glass is blown into metal moulds to create a distinctively asymmetrical shape, and finished with a ripple effect that allows light to tease throughout the pieces' curves. The Duna collection consists of

a pendant and wall sconce, which can be showcased in clusters or as a lone focal point. The wall sconce is especially beloved in a hallway or bedroom, transforming a conventional layout to an extraordinary spacial design. The collection's stunning, yet unapologetic, shapes can elevate any setting to a space that demands to be seen and remembered.

Duna Wall Sconce
—
Design
Zaha Hadid Design



Glitters

The Glitters collection was created by Czech designer and architect Gabriela Náhlíková, who aims to free her design language from customary perspectives by applying a fresh approach. The Glitters collection builds on the author's unconventional style by creating "pleats" in the glass in order to play with reflections and shadows. When lit, the light slides in and out

of the angles, creating an array of lights across the room.

Glitters offers a pendant in single, double and triple sizes, table lamp and wall sconce. Due to its simple elegance, each piece of the Glitters collection can create an alluring ambience in a spa setting or bedroom, elevating each space with the feeling of romance and glamour.

Glitters Wall Sconce
—
Design
Gabriela Náhlíková



Neverending Glory

Czech talents Jan Plecháč and Henry Wielgus modelled the Neverending Glory collection after the iconic chandeliers hung in five of the world's most illustrious stages; Moscow's Bolshoi Theatre, the Estates Theatre in Prague, the Palais Garnier in Paris, Milan's La Scala and the Metropolitan Opera House in New York City. The collection transports the grandiosity

of the chandeliers into a contemporary form and scale in order to fit modern spaces. Elegant, clean and refined, the Neverending Glory offers a collection of pendants, floor lamps, table lamps and wall sconces. It provides limitless options to shape a space and redefine it with new purpose and feeling.



Neverending Glory Wall Sconce
—
Design
Jan Plecháč & Henry Wielgus



Spin Wall Sconce Small
—
Design
Lucie Koldová

Spin

Lucie Koldová is the author of the Spin lighting. She spent a year at world-renowned designer Erik Levy's studio before opening her own studio in Paris. The Spin lighting's sleek design is based on a clean rotational shape, reminiscent of the precision of a child's spinning top.

When lit, the light reflects against the disc-shaped glass body, casting elliptical shadows against the surrounding interior. The Spin lighting can be hung as a single focal point or in clusters over a dining table in an industrial setting to accentuate clean lines and stark beauty.





Spacey

The Spacey collection was authored by Lukáš Novák, who uses glass as a medium to transmit emotions and stories. The collection's glass bodies mimic the universe. And as we look up to the heavens and marvel, we do so too when looking at the stunning depth of these lighting objects. The author uses a centuries-forgotten technique called Lithyalin

to create the glass spheres. Each sphere has its own distinct markings within its sleek, marble-like finish. Spacey offers pendants in two sizes and a table lamp. The pendants hang perfectly in residential spaces where guests are bound to look into the small microcosm and – as if they were lifting their eyes to the night sky – feel wonder.

Spacey Moon Ceiling Lamp
—
Design
Lukáš Novák





Floor Lamps



Cipher

The Cipher collection was created by the world-famous Yabu Pushelberg design firm. They are known for their attention to detail and uninhibited exploration into artistry. True to form, the Cipher collection blends bold contemporary design with meticulous craftsmanship.

Each glass piece is decorated with a system of precise cuts and engravings.

Light travels only between the connection points, bringing a concert of reflections and shadows into the surrounding space. The collection offers two pendant shapes, table lamps in two sizes, a floor lamp and a wall sconce. Showcased alone or grouped together, the pieces offer a variety of arrangements to transform any modern interior into an unmatched experience.

Cipher Floor Lamp
—
Design
Yabu Pushelberg



Constellation

Constellation was designed by American architect and designer David Rockwell. He is founder of the Rockwell Group, a cross-disciplinary architecture and design firm based in New York City. The Constellation collection is housed in New York City's Grand Central Terminal, uplifting visitors from their daily commute

to an ethereal spacial experience. Constellation offers a ceiling lamp, a wall sconce and floor lamp representing Cassiopeia, Orion's Belt and Polaris respectively. Each piece is modular and offered in bespoke configurations. Wherever displayed, the light becomes the focal point of the space, evoking awe and wonder.

Constellation Floor Lamp Polaris
—
Design
David Rockwell

Hidden Light

Leading Czech designers Henry Wielgus and Jan Plecháč explored the human psyche when creating the vision for Hidden Light. They compared the essence of light to humanity's inner spark; a brightness that can free us from the cage of society's expectations. They materialized this metaphor into a pendant lighting and a floor lamp.

Large glass pieces were blown into a cage-like metal form, yielding a tremendous, yet elaborate, mass of glass blocks to build a solid body. When turned on, Hidden Light's immense glass cage emits light outward, offering a humbling spacial experience in which guests can reflect on their own unique radiance.



Hidden Light Floor Lamp
—
Design
Jan Plecháč & Henry Wielgus



Neverending Glory

Czech talents Jan Plecháč and Henry Wielgus modelled the Neverending Glory collection after the iconic chandeliers hung in five of the world's most illustrious stages; Moscow's Bolshoi Theatre, the Estates Theatre in Prague, the Palais Garnier in Paris, Milan's La Scala and the Metropolitan Opera House in New York City. The collection transports the grandiosity

of the chandeliers into a contemporary form and scale in order to fit modern spaces. Elegant, clean and refined, the Neverending Glory offers a collection of pendants, floor lamps, table lamps and wall sconces. It provides limitless options to shape a space and redefine it with new purpose and feeling.

Neverending Glory
La Scala Floor Lamp
—
Design
Jan Plecháč & Henry Wielgus





Press

The Press Lamp collection was created by the world-renowned, Tokyo-based Nendo design studio. Following the minimalistic approach to contemporary Japanese design, Press Lamp offers pieces that are not only stunning in their simplicity, but subtly play with the space between the design. The angles of the pinched surface savour the light, containing it within the cylindrical form in order to maintain

a gentle glow. Because the collection has an unwaveringly clean and thoughtful design language, it is exquisite in clusters, reshaping a space with breathtaking softness and vulnerability. The ICE storyline adds a greater depth to the space between the design, while with Press, the light is hushed and indistinct, uplifting guests in an ambience of warmth and awe.

Press Floor Lamps
 (From Left to Right)
 Press Large Clear
 Press Large Smoke
 Press Small Clear
 Press Small Smoke
 —
 Design
 Nendo

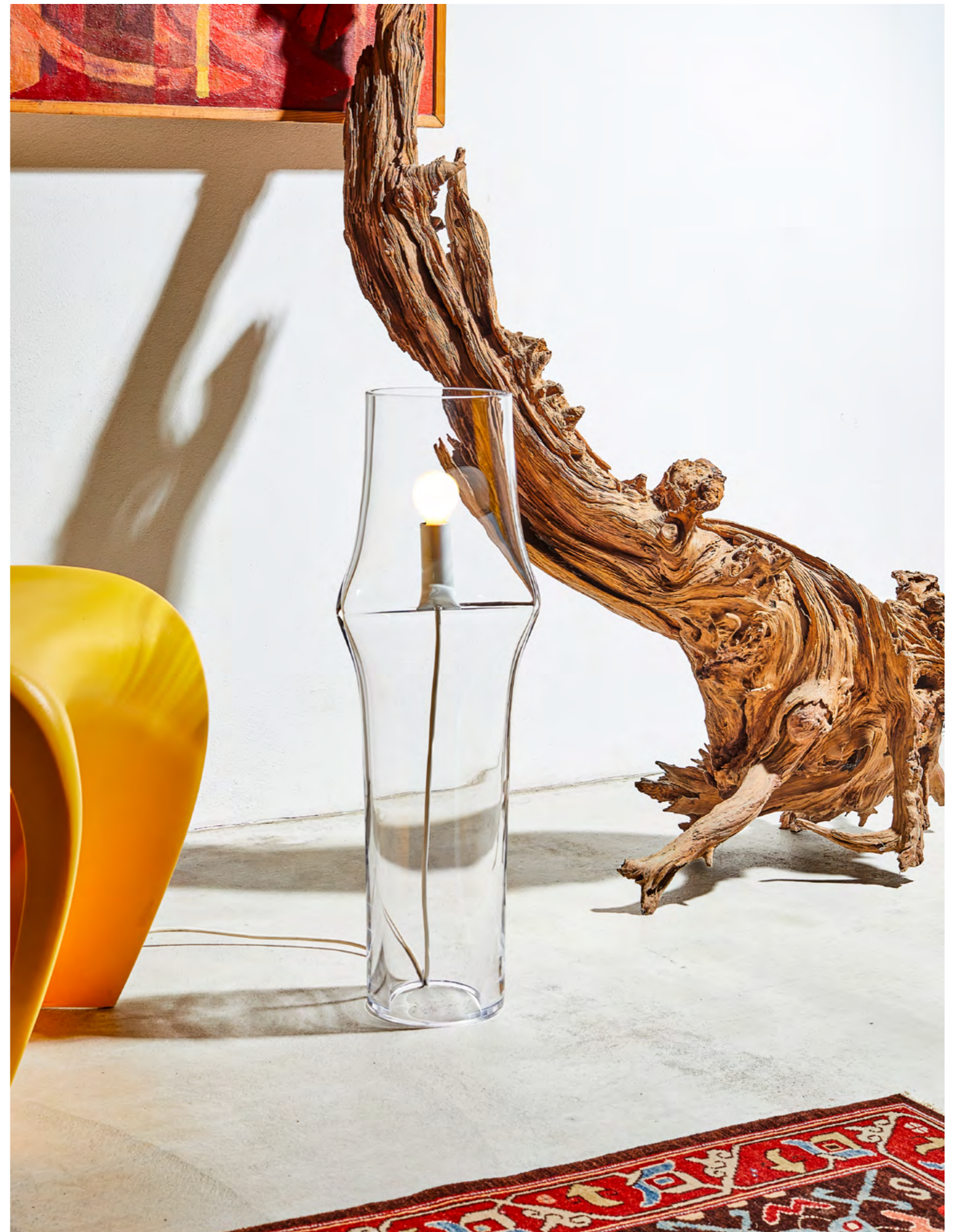

Spacey



The Spacey collection was authored by Lukáš Novák, who uses glass as a medium to transmit emotions and stories. The collection's glass bodies mimic the universe. And as we look up to the heavens and marvel, we do so too when looking at the stunning depth of these lighting objects. The author uses a centuries-forgotten technique called Lithyalin

to create the glass spheres. Each sphere has its own distinct markings within its sleek, marble-like finish. Spacey offers pendants in two sizes and a table lamp. The pendants hang perfectly in residential spaces where guests are bound to look into the small microcosm and – as if they were lifting their eyes to the night sky – feel wonder.

Spacey Midnight Sun
Floor Lamp
—
Design
Lukáš Novák



Transmission
Floor lamp
—
Design
deFORM

Transmission

The Transmission collection was created by Studio deFORM, who continuously look to broaden their design approaches in interesting and compelling ways. The Transmission collection was formed through experimentation with Simax borosilicate glass and manufactured in collaboration with Kavalierglass.

The nearly hemispherical shades of glass frame the luminaire, allowing

surprising shadows and reflections to slide over the curves. The clean, rounded glass is joined together by hard steel, giving the delicate form an elegant durability. The collection includes a light sculpture and a floor lamp. Each lighting sculpture fits well alone or along the ceiling of a minimalist interior design, uplifting the space with a distinctly stark, yet charismatic, spacial experience.



Table Lamps

Cipher

The Cipher collection was created by the world-famous Yabu Pushelberg design firm. They are known for their attention to detail and uninhibited exploration into artistry. True to form, the Cipher collection blends bold contemporary design with meticulous craftsmanship.

Each glass piece is decorated with a system of precise cuts and engravings.

Light travels only between the connection points, bringing a concert of reflections and shadows into the surrounding space. The collection offers two pendant shapes, table lamps in two sizes, a floor lamp and a wall sconce. Showcased alone or grouped together, the pieces offer a variety of arrangements to transform any modern interior into an unmatched experience.



Cipher
(From Left to Right)
Cipher Table Lamp Small
Cipher Table Lamp Large
—
Design
Yabu Pushelberg





Crystal Rock

The Crystal Rock collection was designed by Arik Levy, whose work is exhibited in museums and galleries worldwide. Each piece of the collection is sharply cut and polished to form a contemporary geometric design. The glass has the perfect alignment of density, transparency and acute edges, casting a myriad of gentle reflections throughout the piece. The collection consists

of pendants in three sizes and a table lamp – making it a flexible tool for creating a bespoke space with its own unique journey. Because the collection’s spacial design concept is so versatile, it can be displayed alone or in clusters over dining tables, staircases or hospitality entrances, elevating guests from a fixed locale to a memorable, immersive experience.

Crystal Rock Table Lamp
—
Design
Arik Levy





Flux

The Flux table lamp was designed by Ed Ng and Terence Ngan of AB Concept in Hong Kong, an international luxury design powerhouse. The table lamp is influenced by the way the light reflects off the top of the ocean and the imprints left in the sand by the receding shallow waters. Using traditional layering approaches from classic

Asian ceramics, the Flux table lamp's glass body is stratified with hand painted gold and platinum layers in a timelessly fluid, yet modern, aesthetic. The table lamp can be showcased in small clusters or as a centrepiece of a room to lift the space with an organic, natural atmosphere and a touch of luxury.

Flux Table Lamp
—
Design
Ed Ng & Terence Ngan



Glitters

The Glitters collection was created by Czech designer and architect Gabriela Náhlíková, who aims to free her design language from customary perspectives by applying a fresh approach. The Glitters collection builds on the author's unconventional style by creating "pleats" in the glass in order to play with reflections and shadows. When lit, the light slides in and out

of the angles, creating an array of lights across the room.

Glitters offers a pendant in single, double and triple sizes, table lamp and wall sconce. Due to its simple elegance, each piece of the Glitters collection can create an alluring ambience in a spa setting or bedroom, elevating each space with the feeling of romance and glamour.

Glitters Table Lamp
—
Design
Gabriela Náhlíková



Lollipop

The Lollipop collection was designed by Boris Klimek, who has received numerous prizes for his work. His designs are conceptual, often telling stories through poetry, playfulness and fantasy. This design approach rings true for Lollipop, where each lighting object is a formless glass plate, toying with the colour and structure within. The collection offers pendant lighting

in three shapes and five colours, and a table lamp also in five colors – the possibilities for redefining a room are expansive. Due to the playful nature of the lighting, each piece or cluster fits perfectly in a child's bedroom, brightening up the space with joy and imagination. Lollipop also brings a splash of colour to open interiors to invite a little whimsy and fun.

Lollipop Table Lamp
—
Design
Boris Klimek





Neverending Glory

Czech talents Jan Plecháč and Henry Wielgus modelled the Neverending Glory collection after the iconic chandeliers hung in five of the world's most illustrious stages; Moscow's Bolshoi Theatre, the Estates Theatre in Prague, the Palais Garnier in Paris, Milan's La Scala and the Metropolitan Opera House in New York City. The collection transports the grandiosity

of the chandeliers into a contemporary form and scale in order to fit modern spaces. Elegant, clean and refined, the Neverending Glory offers a collection of pendants, floor lamps, table lamps and wall sconces. It provides limitless options to shape a space and redefine it with new purpose and feeling.

Neverending Glory
La Scala Table Lamp
—
Design
Jan Plecháč & Henry Wielgus



Spacey

The Spacey collection was authored by Lukáš Novák, who uses glass as a medium to transmit emotions and stories. The collection's glass bodies mimic the universe. And as we look up to the heavens and marvel, we do so too when looking at the stunning depth of these lighting objects. The author uses a centuries-forgotten technique called Lithyalin

to create the glass spheres. Each sphere has its own distinct markings within its sleek, marble-like finish. Spacey offers pendants in two sizes and a table lamp. The pendants hang perfectly in residential spaces where guests are bound to look into the small microcosm and – as if they were lifting their eyes to the night sky – feel wonder.



Spacey Lunar Table Lamp
—
Design
Lukáš Novák



Yakisugi

Renowned Japanese designer Kengo Kuma is the author of the Yakisugi collection. Yakisugi confronts two opposing materials – wood and glass. Molten glass is poured into a wooden mould, which catches fire from the inside, capturing the wooden texture into the glass. This technique is reminiscent of the traditional Yakisugi approach, where wood siding is charred by fire to preserve it.

Yakisugi offers a floor lamp and pendants that can be showcased in clusters or alone for a clean, minimalistic feel. Every special design choice is unique, because a wooden mould is used only once for each lighting object. So, each piece has a distinct texture. Yakisugi uplifts any space into one of tranquillity, in which nature lives harmoniously with modernity.





























Yakisugi Table Lamp
—
Design
Kengo Kuma



Pendants & Chandeliers

From A to Z

- Glass Color**
-  01 Clear
 -  02 Opal
 -  03 Smoke
 -  04 Light Amber
 -  05 Iris
 -  07 Red
 -  08 Blue
 -  11 Light Pink
 -  12 Orange
 -  14 Turquoise
 -  15 Light Blue
 -  16 Clear Matt
 -  18 Light Smoke Matt
 -  23 Gold
 -  24 Silver
 -  25 Perla Nera
 -  26 Sandblasted
 -  27 Violet
 -  28 Copper
 -  31 Amber
 -  43 Rainbow Blue
 -  44 Lithyalin
 -  45 Mist
 -  54 Light Smoke
 -  63 Transparent Copper
 -  64 Medium Copper
 - 99 By Design
- Unique Product**
- LED light source**
- LED CUSTOM**
LED light source with custom socket
- Standard Light Source**
- Dimmable**
- | | |
|------|------|
| E12 | E14 |
| E26 | E27 |
| 2G11 | G4 |
| G9 | GU10 |
| G13 | |
- Socket type**
- CE / UL / CCC Certification**
- Please contact us for other possible certifications such as KC, BIS, PSE, SAA.

 For price and lead time contact your seller.

The dimensions of glass components may differ due to their hand made nature.



1600 mm / 63"

AND WHY NOT!
by René Roubíček

Chandelier
CL009SA

Weight / 35 kg / 77 lbs
Primary Material /
Hand Shaped Glass

LED G4

Finishes / Metal Parts
Polished Stainless Steel

Certification /
CE, UL

Colors
01

Ø 1600 mm / 63"



2052 mm / 80 13/16"

CANDY
by Campana Brothers

Sphere Chandelier
CL013SA

Weight / 114,5 kg / 252,5 lbs
Primary Material /
Hand Blown Glass

LED G9

Finishes / Metal Parts
Titanium Gold Mirror

Certification /
CE, UL

Colors
99

Ø 830 mm / 32 11/16"

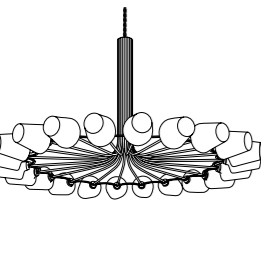

2850 mm / 112 3/16"
800 mm / 31 1/2"

CANDY
by Campana Brothers

Ring Chandelier
CL013SB

Weight / 66,5 kg / 146,5 lbs
Primary Material /
Hand Blown Glass

LED G9

Finishes / Metal Parts
Titanium Gold Mirror

Certification /
CE, UL

Colors
99

Ø 1500 mm / 59 1/16"

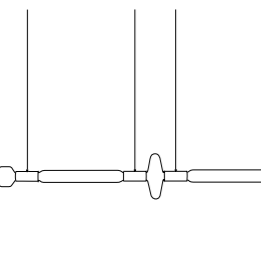

2000 mm / 78 3/4"

CIPHER
by Yabu Pushelberg

Pendant Horizontal Short
CL036PA

Weight / 9 kg / 20 lbs
Primary Material /
Hand Blown Technical Glass

LED CUSTOM

Finishes / Metal Parts
Stainless Steel
Titanium Champagne

Certification /
CE, UL, CCC

Colors
01

1340 mm / 52 3/4"

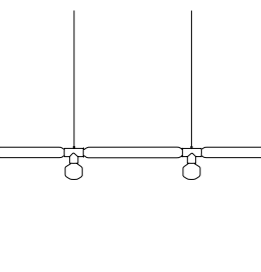

2000 mm / 78 3/4"

CIPHER
by Yabu Pushelberg

Pendant Horizontal Long
CL036PB

Weight / 8,5 kg / 19 lbs
Primary Material /
Hand Blown Technical Glass

LED CUSTOM

Finishes / Metal Parts
Stainless Steel
Titanium Champagne

Certification /
CE, UL, CCC

Colors
01

1630 mm / 64 3/16"

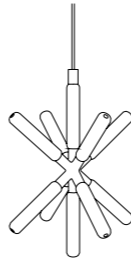

1000 mm / 39 3/8"

CIPHER
by Yabu Pushelberg

Pendant Star
CL036PE

Weight / 15 kg / 33 lbs
Primary Material /
Hand Blown Technical Glass

LED CUSTOM

Finishes / Metal Parts
Stainless Steel
Titanium Champagne

Certification /
CE

Colors
01

Ø 640 mm / 25 3/16"



1270 mm / 50"
870 mm / 34 1/4"

CIPHER
by Yabu Pushelberg

Pendant Vertical S
CL036PC

Weight / 6,3 kg / 13,9 lbs
Primary Material /
Hand Blown Technical Glass

LED CUSTOM

Finishes / Metal Parts
Stainless Steel
Titanium Champagne

Certification /
CE

Colors
01

Ø 220 mm / 8 11/16"



2000 mm / 78 3/4"
870 mm / 34 1/4"

CIPHER
by Yabu Pushelberg

Pendant Vertical L
CL036PD

Weight / 7,2 kg / 15,9 lbs
Primary Material /
Hand Blown Technical Glass

LED CUSTOM

Finishes / Metal Parts
Stainless Steel
Titanium Champagne

Certification /
CE

Colors
01

Ø 220 mm / 8 11/16"



2500 mm / 98 7/16"
180 mm / 7 1/16"

CRYSTAL ROCK
by Arik Levy

Single Pendant
CL017PA

Weight / 3 kg / 6,6 lbs
Primary Material /
Hand Blown Cut Glass

LED G4

Finishes / Metal Parts
Lacquered White Matt
and Polished Stainless
Steel

Certification /
CE, UL

Colors
01
02
08
07
04

Ø 130 mm / 5 1/8"



2500 mm / 98 7/16"
180 mm / 7 1/16"

CRYSTAL ROCK
by Arik Levy

Pendant Cluster of 3
CL017PB

Weight / 6 kg / 13 lbs
Primary Material /
Hand Blown Cut Glass

LED G4

Finishes / Metal Parts
Lacquered White Matt
and Polished Stainless
Steel

Certification /
CE, UL

Colors
01
02
08
07
04

Ø 280 mm / 11 1/32"

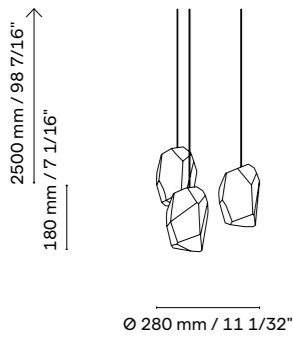

CRYSTAL ROCK

by Arik Levy

Pendant Cluster of 3
CL017PB

Weight / 6 kg / 13 lbs
Primary Material /
Hand Blown Cut Glass

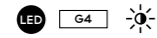

Finishes / Metal Parts

Lacquered White Matt
and Polished Stainless
Steel

Certification /
CE, UL

Colors

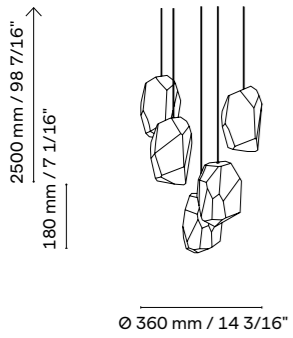
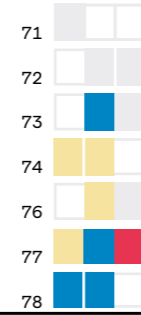

CRYSTAL ROCK

by Arik Levy

Pendant Cluster of 5
CL017PC

Weight / 13 kg / 28, 5 lbs
Primary Material /
Hand Blown Cut Glass

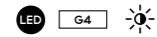

Finishes / Metal Parts

Lacquered White Matt
and Polished Stainless
Steel

Certification /
CE, UL

Colors

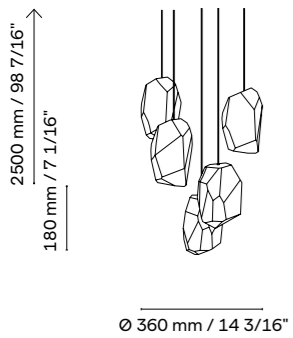
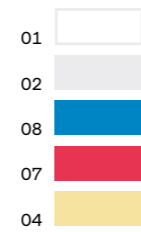

CRYSTAL ROCK

by Arik Levy

Pendant Cluster of 5
CL017PC

Weight / 13 kg / 28, 5 lbs
Primary Material /
Hand Blown Cut Glass

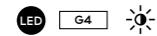

Finishes / Metal Parts

Lacquered White Matt
and Polished Stainless
Steel

Certification /
CE, UL

Colors

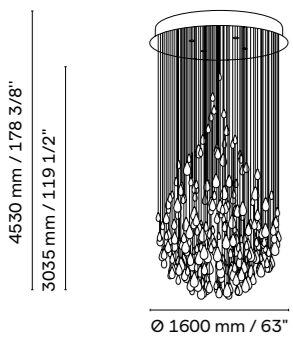
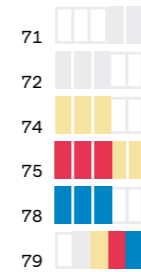

DROPLETS

by Jan Plecháč & Henry Wielgus

Sculpture Large on Ceiling
CL022SB

Weight / 170 kg / 374, 8 lbs
Primary Material /
Hand Blown Glass



Finishes / Metal Parts

Super Polished
Stainless Steel

Certification /
CE, UL

Colors

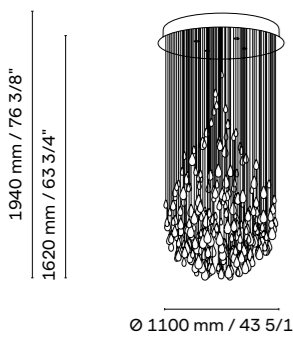
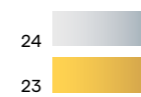

DROPLETS

by Jan Plecháč & Henry Wielgus

Sculpture Small on Ceiling
CL022SA

Weight / 80 kg / 176 lbs
Primary Material /
Hand Blown Glass



Finishes / Metal Parts

Super Polished
Stainless Steel

Certification /
CE, UL

Colors

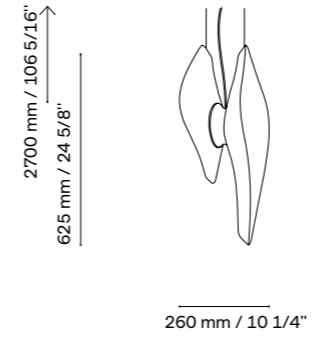
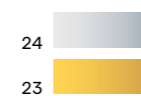

DUNA

by Zaha Hadid Design

Single Pendant
CL038PA

Weight / 15 kg / 33 lbs
Primary Material /
Hand Blown Glass



Finishes / Metal Parts

Aluminium Alloy +
Canopy Stainless Steel

Certification /
CE, UL

Colors

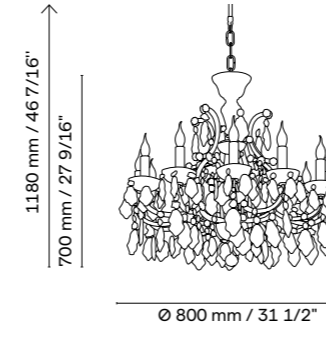

EMPRESS

by Jakub Berdych

Chandelier Low
CL024SC

Weight / 20 kg / 44 lbs
Primary Material /
Hand Blown Glass

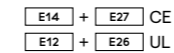

Finishes / Metal Parts

Nickel Plated Glossy

Certification /
CE, UL

Colors

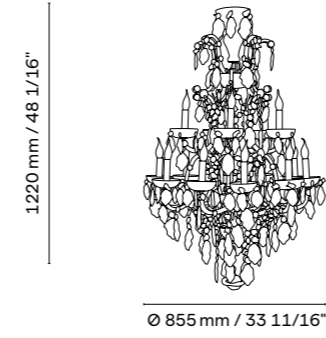
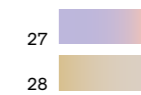

EMPRESS

by Jakub Berdych

Chandelier Small
CL024SA

Weight / 25 kg / 55 lbs
Primary Material /
Hand Blown Glass

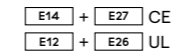

Finishes / Metal Parts

Nickel Plated Glossy

Certification /
CE, UL

Colors

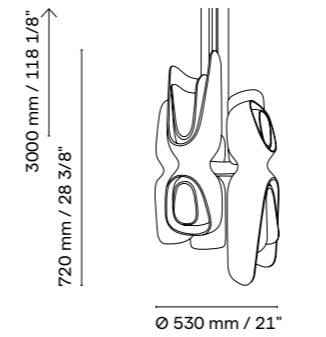
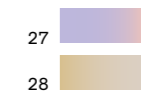

EVE

by Zaha Hadid Design

Pendant
CL037PA

Weight / 45 kg / 99 lbs
Primary Material /
Hand Blown Cut Glass



Finishes / Metal Parts

Clear Matt /
Lacquered White Matt

Light Smoke Matt /
Polished Stainless Steel

Certification /
CE

Colors

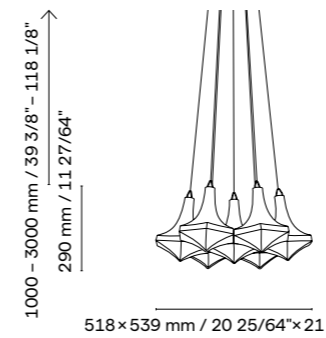
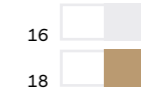

FACET

by Moritz Waldemeyer

Sculpture Cluster of 7
CL023SA

Weight / 11 kg / 24, 2 lbs
Primary Material /
Hand Blown Glass



Finishes / Metal Parts

Lacquered White Matt

Certification /
CE

Colors



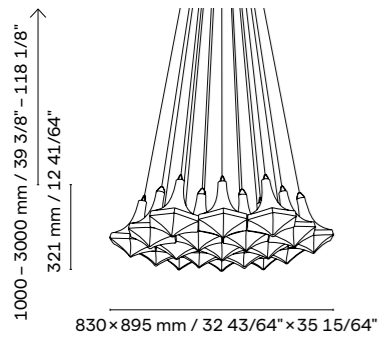

FACET

by Moritz Waldemeyer

Sculpture Cluster of 19
CLO23SB

Weight / 27 kg / 59,4 lbs
Primary Material /
Hand Blown Glass

LED G4

Finishes / Metal Parts
Lacquered White Matt
Certification /
CE

Colors
01

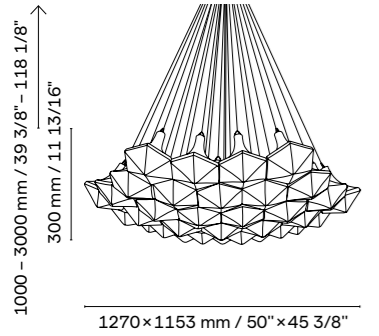

FACET

by Moritz Waldemeyer

Sculpture Cluster of 37
CLO23SC

Weight / 78 kg / 172 lbs
Primary Material /
Hand Blown Glass

LED G4

Finishes / Metal Parts
Lacquered White Matt
Certification /
CE

Colors
01

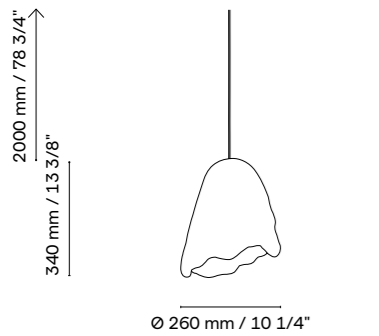

FROZEN

by Maxim Velčovský

Pendant Large
CLO14PB

Weight / 11 kg / 24,3 lbs
Primary Material /
Hand Blown Glass

LED E14 CE E12 UL

Finishes / Metal Parts
Lacquered White Matt
Certification /
CE, UL

Colors
01

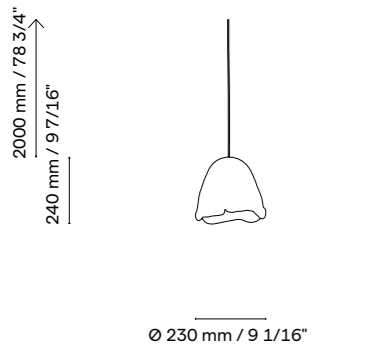

FROZEN

by Maxim Velčovský

Pendant Small
CLO14PA

Weight / 9 kg / 19,8 lbs
Primary Material /
Hand Blown Glass

LED E14 CE E12 UL

Finishes / Metal Parts
Lacquered White Matt
Certification /
CE, UL

Colors
01

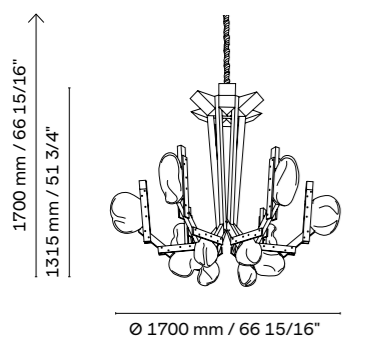

FUNGO

by Campana Brothers

Chandelier Large
CLO32SA

Weight / 80 kg / 176 lbs
Primary Material /
Hand Blown Glass

LED STRIPS

Finishes / Metal Parts
Ash Wood
Walnut Wood
Certification /
CE

Colors
01

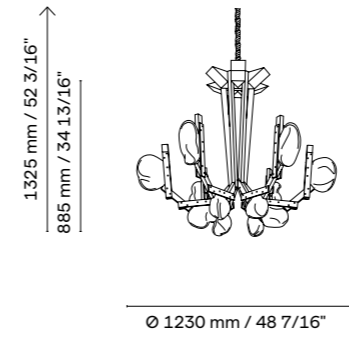

FUNGO

by Campana Brothers

Chandelier Small
CLO32SB

Weight / 30 kg / 66 lbs
Primary Material /
Hand Blown Glass

LED STRIPS

Finishes / Metal Parts
Ash Wood
Walnut Wood
Certification /
CE

Colors
01

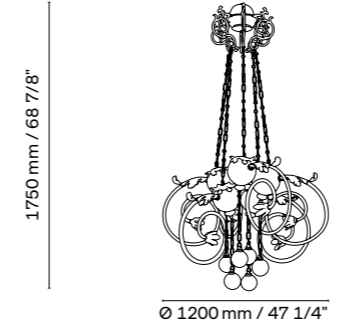

GALAXY LUMINIA

by Bořek Šípek

Galaxy Luminia Quadrix Lenitas
CLO11SC

Weight / 44 kg / 97 lbs
Primary Material /
Hand Blown Glass

LED G4

Finishes / Metal Parts
Polished Brass and
Matt Brass
Certification /
CE, UL

Colors
99
01 / 07 / 08

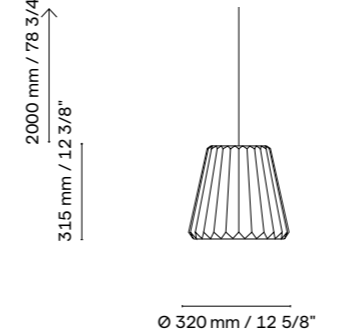

GLITTERS

by Gabriela Náhlíková

Pendant Single
CLO01PA

Weight / 10 kg / 22 lbs
Primary Material /
Crystal

LED E14 CE E12 UL

Finishes / Metal Parts
Brushed Stainless Steel
Certification /
CE, UL, CCC, KC

Colors
01

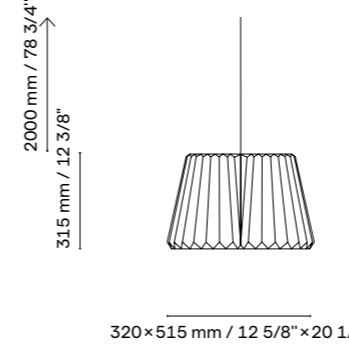

GLITTERS

by Gabriela Náhlíková

Pendant Double
CLO01PB

Weight / 15 kg / 33 lbs
Primary Material /
Crystal

LED E14 CE E12 UL

Finishes / Metal Parts
Brushed Stainless Steel
Certification /
CE, UL, CCC, KC

Colors
01

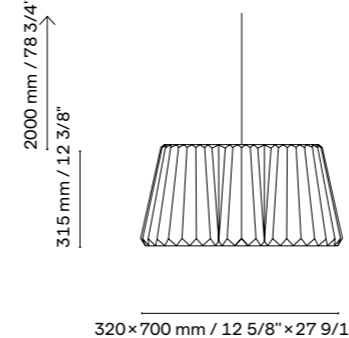

GLITTERS

by Gabriela Náhlíková

Pendant Triple
CLO01PC

Weight / 21 kg / 46,2 lbs
Primary Material /
Crystal

LED E14 CE E12 UL

Finishes / Metal Parts
Brushed Stainless Steel
Certification /
CE, UL, CCC, KC

Colors
01



GLOBE METRO
by Cyril Dunděra

Pendant
CLO92PA

Weight / 3,5 kg / 7,72 lbs
Primary Material /
Hand Blown Technical Glass

LED   CE  UL

Finishes / Metal Parts
Polished Stainless Steel

Certification /
CE, UL

Colors
05 
43 

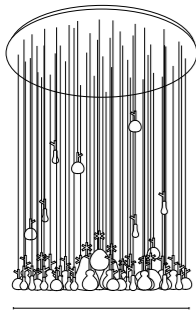

2000 mm / 78 3/4"
485 mm / 19 1/8"
Ø 400 mm / 15 3/4"



GROWING VASES
by Nendo

Sculpture
CLO04SA

Weight / 40 kg / 88 lbs
Primary Material /
Hand Blown Glass

Finishes / Metal Parts
Lacquered White
Glossy CE

Lacquered White
Coated UL

Certification /
CE, UL

Colors
26 

1500 mm / 59 1/16"
Ø 1000 mm / 39 3/8"



HIDDEN LIGHT
by Jan Plecháč & Henry Wielgus

Pendant
CLO96PA

Weight / 15 kg / 33 lbs
Primary Material /
Hand Blown Glass

LED    CE  UL

Finishes / Metal Parts
Brass

Certification /
CE, UL

Colors
01 

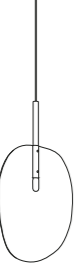

2000 mm / 78 3/4"
450 mm / 17 11/16"
Ø 360 mm / 14 3/16"



LOLLIPOP
by Boris Klimek





Pendant Glass A
CLO25PA

Weight / 8 kg / 17,6 lbs
Primary Material /
Fused Color Glass

LED  

Finishes / Metal Parts
Lacquered White Matt

Certification /
CE

Colors
01 
15 
11 
12 
14 

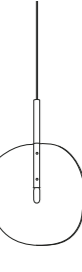

2500 mm / 98 7/16"
830 mm / 32 11/16"
455 mm / 17 15/16"



LOLLIPOP
by Boris Klimek





Pendant Glass B
CLO25PB

Weight / 9 kg / 20 lbs
Primary Material /
Fused Color Glass

LED  

Finishes / Metal Parts
Lacquered White Matt

Certification /
CE

Colors
01 
15 
11 
12 
14 

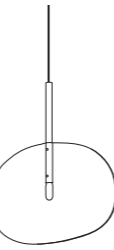

2500 mm / 98 7/16"
744 mm / 29 5/16"
490 mm / 19 5/16"



LOLLIPOP
by Boris Klimek





Pendant Glass C
CLO25PC

Weight / 8 kg / 17,5 lbs
Primary Material /
Fused Color Glass

LED  

Finishes / Metal Parts
Lacquered White Matt

Certification /
CE

Colors
01 
15 
11 
12 
14 

2500 mm / 98 7/16"
730 mm / 28 3/4"
650 mm / 25 9/16"



LUDWIG
by Maurizio Galante

Chandelier Large
CLO30SB

Weight / 230 kg / 507 lbs
Primary Material /
Bent and Straight Technical Glass

LED  

Finishes / Metal Parts
Polished Stainless Steel

Certification /
CE, UL

Colors
01 

2420 mm / 95 1/4"
1242 mm / 48 7/8"
Ø 1364 mm / 53 11/16"



LUDWIG
by Maurizio Galante

Chandelier Small
CLO30SA

Weight / 110 kg / 242,5 lbs
Primary Material /
Bent and Straight Technical Glass

LED  

Finishes / Metal Parts
Polished Stainless Steel

Certification /
CE, UL

Colors
01 

1600 mm / 63"
800 mm / 31 1/2"
Ø 880 mm / 34 5/8"



LUDWIG
by Maurizio Galante

Small Chandelier on a Metal Pole
CL30SC

Weight / 110 kg / 242,5 lbs
Primary Material /
Bent and Straight Technical Glass
Metal Rod

LED  

Finishes / Metal Parts
Polished Stainless Steel
Metal Rod

Certification /
CE, UL

Colors
01 

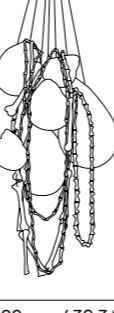

1600 mm / 63"
800 mm / 31 1/2"
Ø 880 mm / 34 5/8"



MEMENTO MORI
by Maxim Velčovský

Sculpture
CLO29SA

Weight / 170 kg / 374 lbs
Primary Material /
Hand Blown Glass

  

Finishes / Metal Parts
Lacquered Black Matt

Certification /
CE, UL

Colors
01 

2000 mm / 78 3/4"
max. 1600 mm / 63"
Ø 1000 mm / 39 3/8"

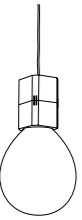



2000 mm / 78 3/4"
520 mm / 20 1/2"

MOULDS
by Jan Plecháč & Henry Wielgus

Pendant Large
CLO15PC

Weight / 6 kg / 13 lbs
Primary Material /
Hand Blown Glass

LED   GU10

Finishes / Metal Parts
Polished Stainless Steel

Certification /
CE, UL

Colors
01 

Ø 290 mm / 11 7/16"

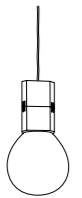



2000 mm / 78 3/4"
420 mm / 16 9/16"

MOULDS
by Jan Plecháč & Henry Wielgus

Pendant Medium
CLO15PB

Weight / 5 kg / 11 lbs
Primary Material /
Hand Blown Glass

LED   GU10

Finishes / Metal Parts
Polished Stainless Steel

Certification /
CE, UL

Colors
01 

Ø 230 mm / 9 1/16"

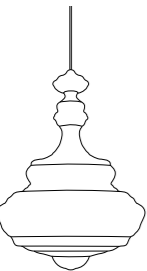



2000 mm / 78 3/4"
780 mm / 31 3/16"

NEVERENDING GLORY
by Jan Plecháč & Henry Wielgus



Bolshoi Theater / Pendant Large
CLO08PA

Weight / 10 kg / 22 lbs
Primary Material /
Hand Blown Glass

LED   E27 CE E26 UL

Finishes / Metal Parts
Clear /
Lacquered White Matt
Opal /
Lacquered White Matt
Smoke /
Lacquered Black Matt

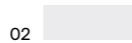
Certification /
CE, UL, CCC, KC

Colors
01 
02 
03 

Ø 550 mm / 21 5/8"

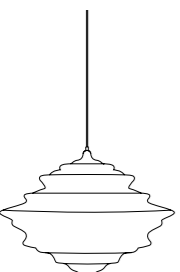



2000 mm / 78 3/4"
460 mm / 18 1/8"

NEVERENDING GLORY
by Jan Plecháč & Henry Wielgus



Metropolitan Opera / Pendant Large
CLO08PB

Weight / 8,8 kg / 19,4 lbs
Primary Material /
Hand Blown Glass

LED   E27 CE E26 UL

Finishes / Metal Parts
Clear /
Lacquered White Matt
Opal /
Lacquered White Matt
Smoke /
Lacquered Black Matt

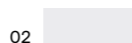
Certification /
CE, UL, CCC, KC

Colors
01 
02 
03 

Ø 550 mm / 21 5/8"

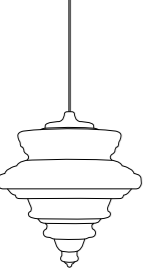



2000 mm / 78 3/4"
640 mm / 25 3/16"

NEVERENDING GLORY
by Jan Plecháč & Henry Wielgus



La Scala / Pendant Large
CLO08PC

Weight / 10 kg / 22 lbs
Primary Material /
Hand Blown Glass

LED   E27 CE E26 UL

Finishes / Metal Parts
Clear /
Lacquered White Matt
Opal /
Lacquered White Matt
Smoke /
Lacquered Black Matt

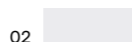
Certification /
CE, UL, CCC, KC

Colors
01 
02 
03 

Ø 550 mm / 21 5/8"

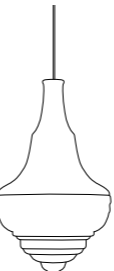



2000 mm / 78 3/4"
780 mm / 30 11/16"

NEVERENDING GLORY
by Jan Plecháč & Henry Wielgus



Prague Estates Theater / Pendant Large
CLO08PD

Weight / 8 kg / 17,5 lbs
Primary Material /
Hand Blown Glass

LED   E27 CE E26 UL

Finishes / Metal Parts
Clear /
Lacquered White Matt
Opal /
Lacquered White Matt
Smoke /
Lacquered Black Matt

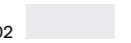
Certification /
CE, UL, CCC, KC

Colors
01 
02 
03 

Ø 440 mm / 17 5/16"

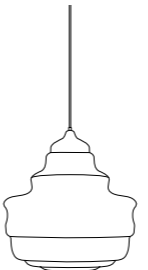



2000 mm / 78 3/4"
600 mm / 23 5/8"

NEVERENDING GLORY
by Jan Plecháč & Henry Wielgus



Palais Garnier / Pendant Large
CLO08PE

Weight / 10 kg / 22 lbs
Primary Material /
Hand Blown Glass

LED   E27 CE E26 UL

Finishes / Metal Parts
Clear /
Lacquered White Matt
Opal /
Lacquered White Matt
Smoke /
Lacquered Black Matt

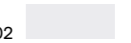
Certification /
CE, UL, CCC, KC

Colors
01 
02 
03 

Ø 510 mm / 20 1/16"

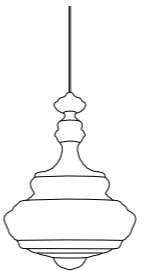



2000 mm / 78 3/4"
580 mm / 22 13/16"

NEVERENDING GLORY
by Jan Plecháč & Henry Wielgus



Bolshoi Theater / Pendant Medium
CLO08PK

Weight / 8,4 kg / 18,6 lbs
Primary Material /
Hand Blown Glass

LED   E27 CE E26 UL

Finishes / Metal Parts
Clear /
Lacquered White Matt
Opal /
Lacquered White Matt
Smoke /
Lacquered Black Matt

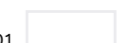
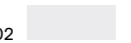
Certification /
CE, UL, CCC, KC

Colors
01 
02 
03 

Ø 413 mm / 16 1/4"

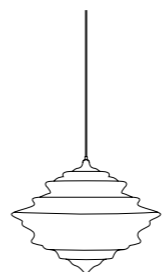



2000 mm / 78 3/4"
320 mm / 12 5/8"

NEVERENDING GLORY
by Jan Plecháč & Henry Wielgus



Metropolitan Opera / Pendant Medium
CLO08PL

Weight / 8,9 kg / 19,7 lbs
Primary Material /
Hand Blown Glass

LED   E27 CE E26 UL

Finishes / Metal Parts
Clear /
Lacquered White Matt
Opal /
Lacquered White Matt
Smoke /
Lacquered Black Matt

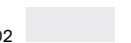
Certification /
CE, UL, CCC, KC

Colors
01 
02 
03 

Ø 413 mm / 16 1/4"

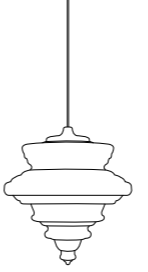



2000 mm / 78 3/4"
474 mm / 18 11/16"

NEVERENDING GLORY
by Jan Plecháč & Henry Wielgus



La Scala / Pendant Medium
CLO08PM

Weight / 7,5 kg / 16,6 lbs
Primary Material /
Hand Blown Glass

LED   E27 CE E26 UL

Finishes / Metal Parts
Clear /
Lacquered White Matt
Opal /
Lacquered White Matt
Smoke /
Lacquered Black Matt

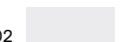
Certification /
CE, UL, CCC, KC

Colors
01 
02 
03 

Ø 412 mm / 16 1/4"

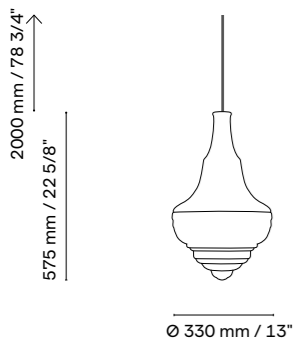

NEVERENDING GLORY

by Jan Plecháč & Henry Wielgus

Prague Estates Theater / Pendant Medium
CLO08PN

Weight / 6,6 kg / 14,6 lbs
Primary Material /
Hand Blown Glass

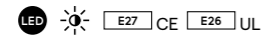

Finishes / Metal Parts

Clear /
Lacquered White Matt

Opal /
Lacquered White Matt

Smoke /
Lacquered Black Matt

Certification /
CE, UL, CCC, KC

Colors

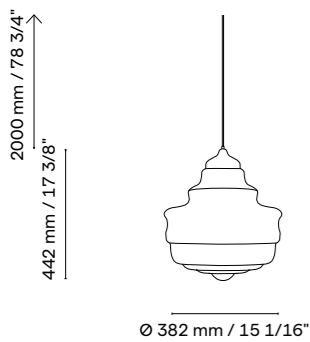
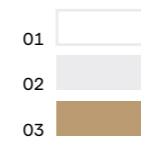

NEVERENDING GLORY

by Jan Plecháč & Henry Wielgus

Palais Garnier / Pendant Medium
CLO08PO

Weight / 6,1 kg / 13,5 lbs
Primary Material /
Hand Blown Glass

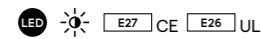

Finishes / Metal Parts

Clear /
Lacquered White Matt

Opal /
Lacquered White Matt

Smoke /
Lacquered Black Matt

Certification /
CE, UL, CCC, KC

Colors

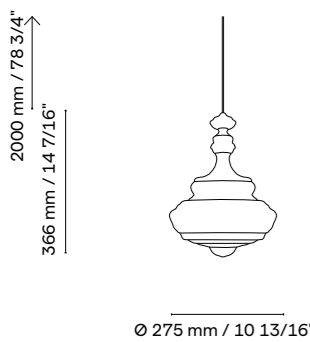
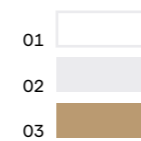

NEVERENDING GLORY

by Jan Plecháč & Henry Wielgus

Bolshoi Theater / Pendant Small
CLO08PF

Weight / 4 kg / 8 lbs
Primary Material /
Hand Blown Glass

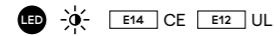

Finishes / Metal Parts

Clear /
Lacquered White Matt

Opal /
Lacquered White Matt

Smoke /
Lacquered Black Matt

Certification /
CE, UL, CCC, KC

Colors

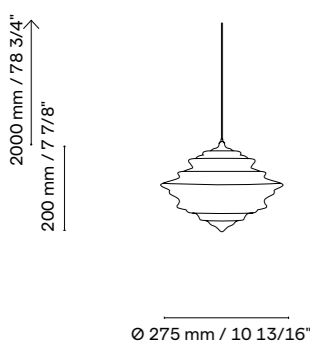
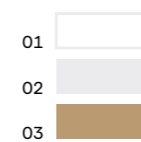

NEVERENDING GLORY

by Jan Plecháč & Henry Wielgus

Metropolitan Opera / Pendant Small
CLO08PG

Weight / 2,9 kg / 6 lbs
Primary Material /
Hand Blown Glass

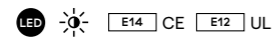

Finishes / Metal Parts

Clear /
Lacquered White Matt

Opal /
Lacquered White Matt

Smoke /
Lacquered Black Matt

Certification /
CE, UL, CCC, KC

Colors

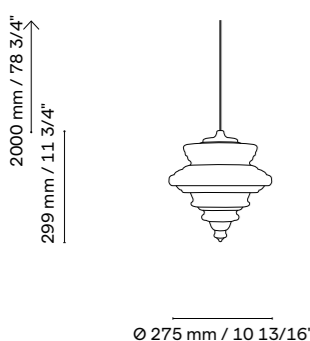
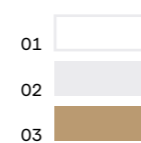

NEVERENDING GLORY

by Jan Plecháč & Henry Wielgus

La Scala / Pendant Small
CLO08PH

Weight / 3,7 kg / 8 lbs
Primary Material /
Hand Blown Glass

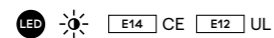

Finishes / Metal Parts

Clear /
Lacquered White Matt

Opal /
Lacquered White Matt

Smoke /
Lacquered Black Matt

Certification /
CE, UL, CCC, KC

Colors

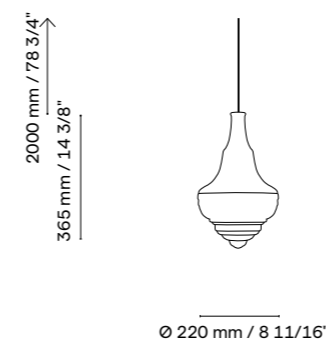
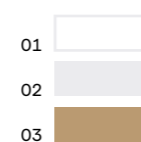

NEVERENDING GLORY

by Jan Plecháč & Henry Wielgus

Prague Estates Theater / Pendant Small
CLO08PI

Weight / 3 kg / 6 lbs
Primary Material /
Hand Blown Glass

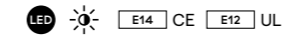

Finishes / Metal Parts

Clear /
Lacquered White Matt

Opal /
Lacquered White Matt

Smoke /
Lacquered Black Matt

Certification /
CE, UL, CCC, KC

Colors

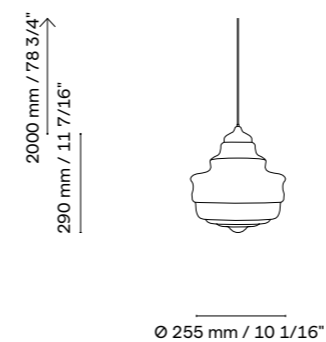
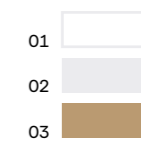

NEVERENDING GLORY

by Jan Plecháč & Henry Wielgus

Palais Garnier / Pendant Small
CLO08PJ

Weight / 3,4 kg / 7,5 lbs
Primary Material /
Hand Blown Glass

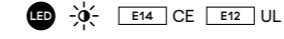

Finishes / Metal Parts

Clear /
Lacquered White Matt

Opal /
Lacquered White Matt

Smoke /
Lacquered Black Matt

Certification /
CE, UL, CCC, KC

Colors

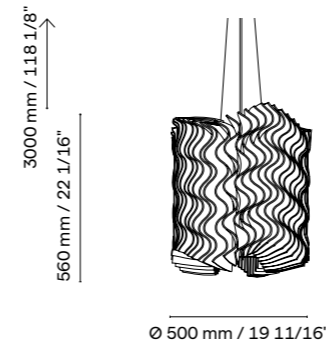
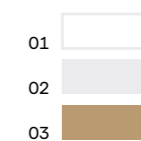

PLISSE

by Maurizio Galante

Chandelier Small
CLO10SA

Weight / 58 kg / 127,8 lbs
Primary Material /
Clear Fused Artistic Glass

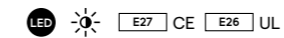

Finishes / Metal Parts

Polished Stainless Steel
Lacquered Black Matt

Certification /
CE, UL

Colors

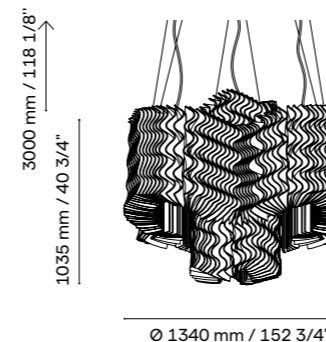

PLISSE

by Maurizio Galante

Chandelier Large
CLO10SB

Weight / 370 kg / 367,8 lbs
Primary Material /
Clear Fused Artistic Glass

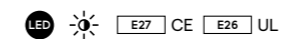

Finishes / Metal Parts

Polished Stainless Steel
Lacquered Black Matt

Certification /
CE, UL

Colors

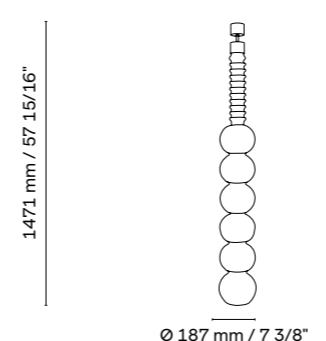

PRAHA

by Stanislav Libenský

Single Pendant Long
CLO26SA

Weight / 8 kg / 17,5 lbs
Primary Material /
Hand Blown Glass

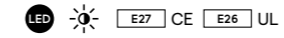

★ LIMITED EDITION

Finishes / Metal Parts

Titanium Gold Mirror
Polished Brass

Certification /
CE, UL

Colors





1006 mm / 39 5/8"



PRAHA
by Stanislav Libenský

Single Pendant Short
CLO26SB

Weight / 6 kg / 13, 2 lbs
Primary Material /
Hand Blown Glass

LED   CE  UL

◆ LIMITED EDITION

Ø 187 mm / 7 3/8"

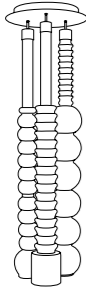

1520 mm / 59 13/16"



PRAHA
by Stanislav Libenský

Pendant Cluster of 3 Long
CLO26SC

Weight / 25 kg / 55 lbs
Primary Material /
Hand Blown Glass

LED   CE  UL

◆ LIMITED EDITION

Ø 460 mm / 18 1/8"

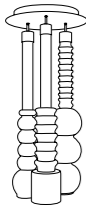

1098 mm / 43 1/4"



PRAHA
by Stanislav Libenský

Pendant Cluster of 3 Short
CLO26PF

Weight / 19 kg / 42 lbs
Primary Material /
Hand Blown Glass

LED   CE  UL

◆ LIMITED EDITION

Ø 460 mm / 18 1/8"

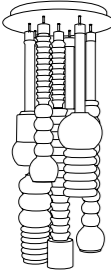

1624 mm / 63 15/16"



PRAHA
by Stanislav Libenský

Pendant Cluster of 7
CLO26SD

Weight / 61 kg / 134, 5 lbs
Primary Material /
Hand Blown Glass

LED   CE  UL

◆ LIMITED EDITION

Ø 700 mm / 27 9/16"

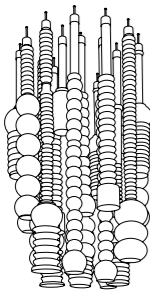

2255 mm / 88 3/4"



PRAHA
by Stanislav Libenský

Pendant Cluster of 22
CLO26SE

Weight / 232 kg / 511, 5 lbs
Primary Material /
Hand Blown Glass

LED   CE  UL

◆ LIMITED EDITION

Ø 1200 mm / 47 1/2"

Finishes / Metal Parts
Titanium Gold Mirror
Polished Brass

Colors
01 

Certification /
CE, UL

Finishes / Metal Parts
Titanium Gold Mirror
Polished Brass

Colors
01 

Certification /
CE, UL

Finishes / Metal Parts
Titanium Gold Mirror
Polished Brass

Colors
01 

Certification /
CE, UL

Finishes / Metal Parts
Titanium Gold Mirror
Polished Brass

Colors
01 

Certification /
CE, UL

Finishes / Metal Parts
Titanium Gold Mirror
Polished Brass

Colors
01 

Certification /
CE, UL



2000 mm / 78 3/4"
450 mm / 17 11/16"



PRESS
by Nendo



Pendant
CLO06PA

Weight / 2, 5 kg / 5, 5 lbs
Primary Material /
Hand Blown Glass

LED   CE  UL

Ø 114 mm / 4 1/2"

Finishes / Metal Parts
Clear /
Lacquered White
Glossy

Colors
01 
03 

Smoke /
Lacquered Black Matt

Certification /
CE, UL



2000 mm / 78 3/4"
450 mm / 17 11/16"



PRESS ICED
by Nendo

Pendant
CLO06PB

Weight / 2, 5 kg / 5, 5 lbs
Primary Material /
Hand Blown Glass

LED   CE  UL

Ø 114 mm / 4 1/2"

Finishes / Metal Parts
Clear /
Lacquered White
Glossy

Colors
01 

Smoke /
Lacquered Black Matt

Certification /
CE, UL

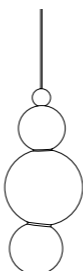

2000 mm / 78 3/4"
700 mm / 27 9/16"



SPACEY
by Lukáš Novák

Eclipse Pendant
CLO94PB

Weight / 5, 5 kg / 12 lbs
Primary Material /
Hand Blown Glass

LED   CE  UL

◆

Ø 300 mm / 11 13/16"

Finishes / Metal Parts
Lacquered Black Matt
and Polished Brass

Colors
44 

Certification /
CE, UL

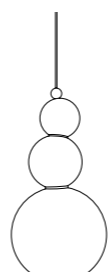

2000 mm / 78 3/4"
722 mm / 28 7/16"



SPACEY
by Lukáš Novák

Supermoon Pendant
CLO94PA

Weight / 7, 5 kg / 16, 5 lbs
Primary Material /
Hand Blown Glass

LED   CE  UL

◆

Ø 350 mm / 13 3/4"

Finishes / Metal Parts
Lacquered Black Matt
and Polished Brass

Colors
44 

Certification /
CE, UL

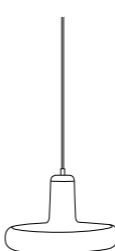

2000 mm / 78 3/4"
330 mm / 13"



SPIN
by Lucie Koldová

Pendant Medium
CLO12PB

Weight / 7, 2 kg / 16 lbs
Primary Material /
Hand Blown Glass

LED   CE  UL

Ø 380 mm / 14 15/16"

Finishes / Metal Parts
Lacquered Black Matt
Nickel Plated Glossy
Polished Brass
Copper Plated

Colors
01 

Certification /
CE, UL

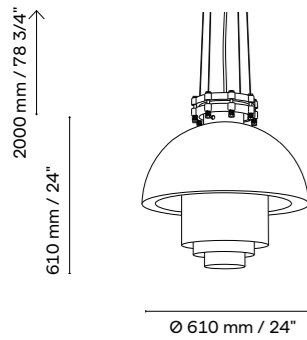

TRANSMISSION

by deFORM

Pendant
CL019SA

Weight / 40 kg / 88 lbs
Primary Material /
Borosilicate Glass

LED TUBE 2 G11

Finishes / Metal Parts

Lacquered Black Glossy

Certification /
CE, UL

Colors

01

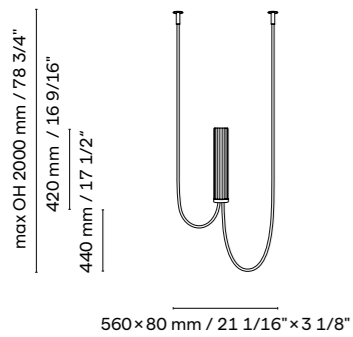

UPSIDE DOWN

by Boris Klimek

Solo Pendant
CL103PA / OH 2000 mm / 78 3/4"
CL103PD / OH 1700 mm / 66 15/16"
CL103PG / OH 1220 mm / 48 1/16"

Weight / 5,5 kg / 12 lbs
Primary Material /
Hand Blown Technical Glass

LED E27 CE E26 UL

Finishes / Metal Parts

Lacquered Black Matt
Antique Rose Gold

Certification /
CE

Colors

54

63

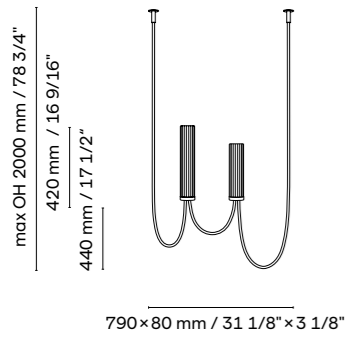

UPSIDE DOWN

by Boris Klimek

Twins Pendant
CL103PB / OH 2000 mm / 78 3/4"
CL103PE / OH 1700 mm / 66 15/16"
CL103PH / OH 1220 mm / 48 1/16"

Weight / 9 kg / 19,8 lbs
Primary Material /
Hand Blown Technical Glass

LED E27 CE E26 UL

Finishes / Metal Parts

Lacquered Black Matt
Antique Rose Gold

Certification /
CE

Colors

54

63

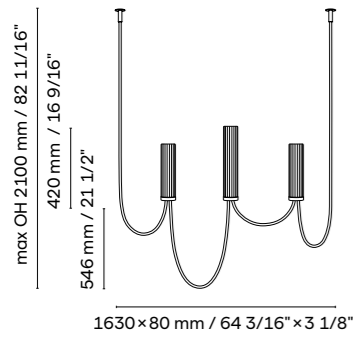

UPSIDE DOWN

by Boris Klimek

Trinity Pendant
CL103PC / OH 2100 mm / 82 11/16"
CL103PF / OH 1800 mm / 70 7/8"
CL103PI / OH 1320 mm / 51 15/16"

Weight / 15 kg / 33 lbs
Primary Material /
Hand Blown Technical Glass

LED E27 CE E26 UL

Finishes / Metal Parts

Lacquered Black Matt
Antique Rose Gold

Certification /
CE

Colors

54

63

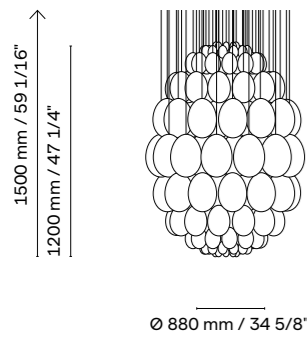

UOVO

by Rony Plesl

Sculpture Small
CL002SA

Weight / 100 kg / 220 lbs
Primary Material /
Hand Blown Glass

LED GU10 G9

Finishes / Metal Parts

Gold /
Titanium Gold Mirror

Silver /
Super Polished
Stainless Steel

Perla Nera /
Titanium Black Mirror

Certification /
CE, UL

Colors

23

24

25

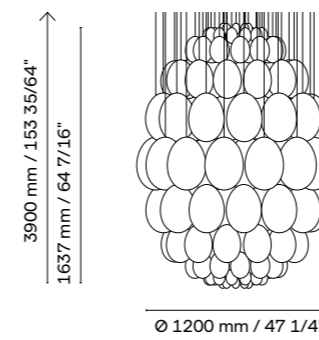

UOVO

by Rony Plesl

Sculpture Large
CL002SB

Weight / 200 kg / 441 lbs
Primary Material /
Hand Blown Glass

LED GU10 G9

Finishes / Metal Parts

Gold /
Titanium Gold Mirror

Silver /
Super Polished
Stainless Steel

Perla Nera /
Titanium Black Mirror

Certification /
CE, UL

Colors

23

24

25

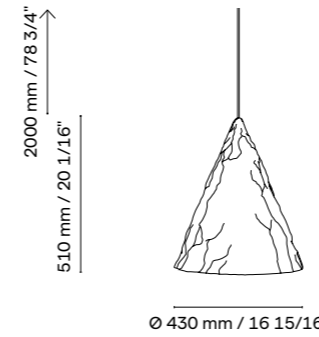

VOLCANO

by Maxim Velčovský

Pendant
CL095PA

Weight / 11 kg / 24,2 lbs
Primary Material /
Hand Blown Glass

LED E27 CE E26 UL

Finishes / Metal Parts

Clear /
Lacquered White Matt

Smoke /
Lacquered Black Matt

Certification /
CE, UL

Colors

01

03

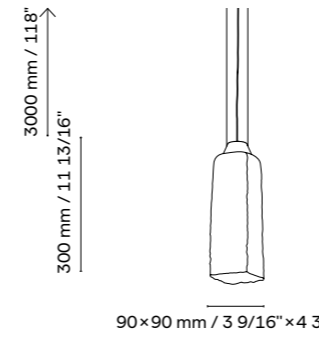

YAKISUGI

by Kengo Kuma

Single Pendant Small
CL035PA

Weight / 4,5 kg / 10 lbs
Primary Material /
Hand Blown Glass

LED CUSTOM



Finishes / Metal Parts

Brushed Stainless Steel

Certification /
CE, UL

Colors

01

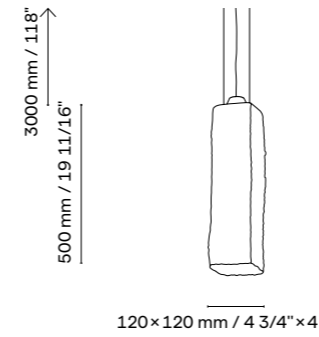

YAKISUGI

by Kengo Kuma

Single Pendant Large
CL035PB

Weight / 12 kg / 26,5 lbs
Primary Material /
Hand Blown Glass

LED CUSTOM



Finishes / Metal Parts

Brushed Stainless Steel

Certification /
CE, UL

Colors

01

Wall & Ceiling Lamps

From A to Z

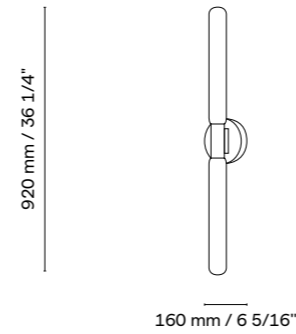

CIPHER

by Yabu Pushelberg

Wall Sconce
CL036WA

Weight / 3,9 kg / 8,5 lb
Primary Material /
Hand Blown Technical Glass
Canopy / Ø 114 mm / 4 31/64"

LED CUSTOM

Finishes / Metal Parts
Stainless Steel
Titanium Champagne
Certification /
CE, UL

Colors
01

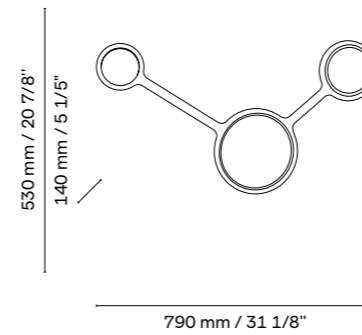

CONSTELLATION

by David Rockwell

Tri Star Wall Sconce
CL123WA

Weight / 18 kg / 39,7 lbs
Primary Material /
Hand Blown Technical Glass

LED CUSTOM

Finishes / Metal Parts
Champagne Stardust
Black Stardust
Certification /
CE

Colors
64

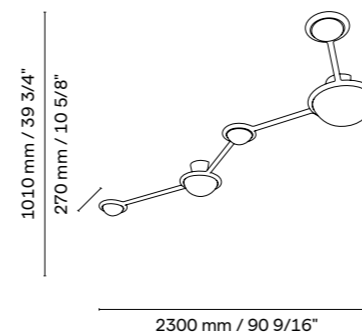

CONSTELLATION

by David Rockwell

Cassiopeia Ceiling Lamp
CL123CA

Weight / 25 kg / 55,1 lbs
Primary Material /
Hand Blown Technical Glass

LED CUSTOM

Finishes / Metal Parts
Champagne Stardust
Black Stardust
Certification /
CE

Colors
64

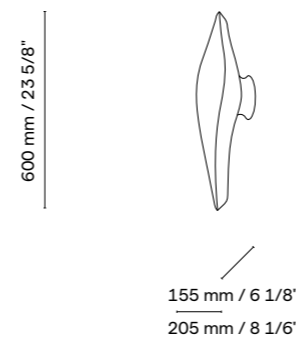

DUNA

by Zaha Hadid Design

Wall Sconce
CL038WA

Weight / 5 kg / 11 lbs
Primary Material /
Hand Blown Glass

LED CUSTOM

Finishes / Metal Parts
Aluminium Alloy
Certification /
CE, UL

Colors
01

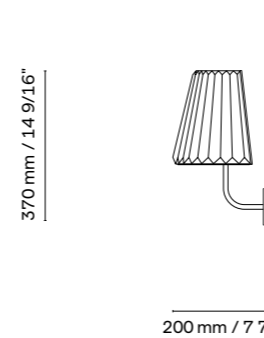

GLITTERS

by Gabriela Náhliková

Wall Sconce
CL001WA

Weight / 3,7 kg / 8,3,5 lbs
Primary Material /
Crystal

LED E14 CE E12 UL

Finishes / Metal Parts
Brushed Stainless Steel
Certification /
CE, UL

Colors
01

Ø 442 mm / 17 3/8"

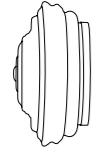

234 mm / 9 3/16"

NEVERENDING GLORY

by Jan Plecháč & Henry Wielgus

Wall Sconce
CLO08WA

Weight / 8,8 kg / 19,5 lbs
Primary Material /
Hand Blown Glass

LED E27 CE E26 UL

Finishes / Metal Parts

Nickel Plated Glossy

Certification /
CE

Colors

01

Ø 327 mm / 12 7/8"

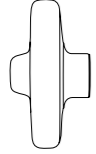

215 mm / 8 7/16"

SPIN

by Lucie Koldová

Wall Sconce Small
CLO12WB

Weight / 4,7 kg / 10 lbs
Primary Material /
Hand Blown Glass

LED E27 CE E26 UL

Finishes / Metal Parts

Lacquered Black Matt
Nickel Plated Glossy
Polished Brass
Copper Plated

Certification /
CE

Colors

01

480 mm / 18 7/8"

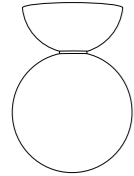

Ø 350 mm / 13 3/4"

SPACEY

by Lukáš Novák

Moon Ceiling Lamp
CLO94CA

Weight / 7,5 kg / 16,5 lbs
Primary Material /
Hand Blown Glass

LED E27 CE E26 UL



Finishes / Metal Parts

Polished Brass

Certification /
CE

Colors

44

Floor Lamps

From A to Z

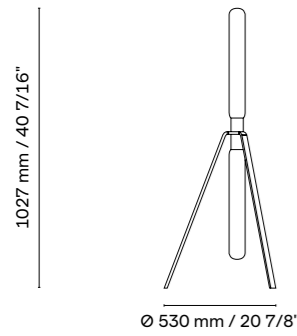

CIPHER

by Yabu Pushelberg

Floor Lamp
CL036FA

Weight / 3,7 kg / 8 lbs
Primary Material /
Hand Blown Technical Glass

LED CUSTOM

Finishes / Metal Parts

Stainless Steel
Titanium Champagne

Certification /
CE, UL, CCC

Colors

01

1027 mm / 40 7/16"

Ø 530 mm / 20 7/8"

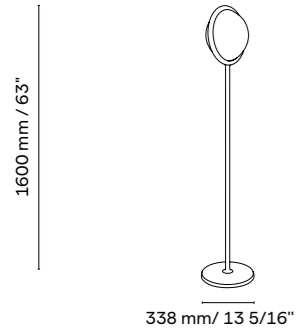

CONSTELLATION

by David Rockwell

Polaris Floor Lamp
CL123FA

Weight / 25 kg / 55,1 lbs
Primary Material /
Hand Blown Technical Glass

LED CUSTOM

Finishes / Metal Parts

Champagne Stardust
Black Stardust

Certification /
CE

Colors

64

1600 mm / 63"

338 mm / 13 5/16"

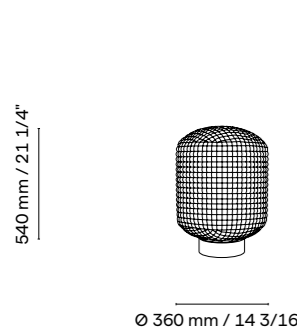

HIDDEN LIGHT

by Jan Plecháč & Henry Wielgus

Floor Lamp
CL096FA

Weight / 26 kg / 57,3 lbs
Primary Material /
Hand Blown Glass

LED E27 CE E26 UL



Finishes / Metal Parts

Brass and Marble

Certification /
CE

Colors

01

540 mm / 21 1/4"

Ø 360 mm / 14 3/16"

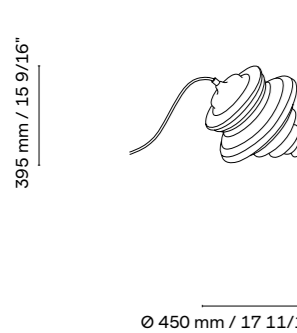

NEVERENDING GLORY

by Jan Plecháč & Henry Wielgus

La Scala Floor Lamp
CL008FC

Weight / 9 kg / 20 lbs
Primary Material /
Hand Blown Glass

LED E27 CE E26 UL

Finishes / Metal Parts

Lacquered White
Matt

Certification /
CE, UL

Colors

01

395 mm / 15 9/16"

Ø 450 mm / 17 11/16"

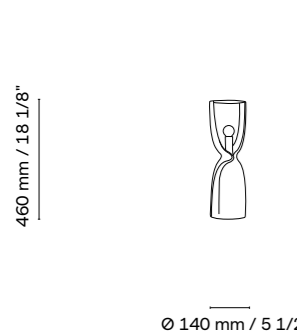

PRESS

by Nendo

Floor Lamp Small
CL006FA

Weight / 5,3 kg / 11,5 lbs
Primary Material /
Hand Blown Glass

LED E14 CE E12 UL

Finishes / Metal Parts

Clear /
Lacquered White
Glossy

Smoke /
Lacquered Black Matt

Certification /
CE, UL

Colors

01

03

460 mm / 18 1/8"

Ø 140 mm / 5 1/2"

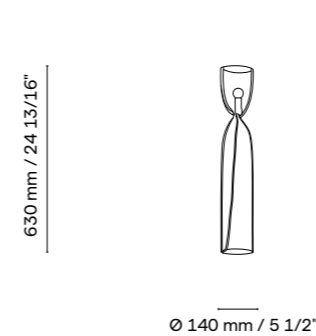

PRESS

by Nendo

Floor Lamp Large
CL006FB

Weight / 7,3 kg / 16 lbs
Primary Material /
Hand Blown Glass

LED E14 CE E12 UL

Finishes / Metal Parts

Clear /
Lacquered White
Glossy

Smoke /
Lacquered Black Matt

Certification /
CE, UL

Colors

01

03

630 mm / 24 13/16"

Ø 140 mm / 5 1/2"

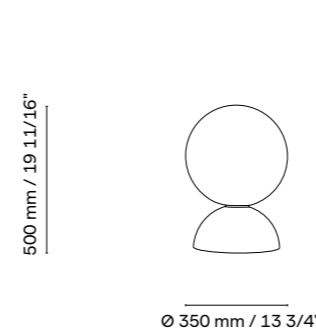

SPACEY

by Lukáš Novák

Midnight Sun Floor Lamp
CL094FA

Weight / 8 kg / 17,6 lbs
Primary Material /
Hand Blown Glass

LED E27 CE E26 UL



Finishes / Metal Parts

Polished Brass

Certification /
CE, UL

Colors

44

500 mm / 19 11/16"

Ø 350 mm / 13 3/4"

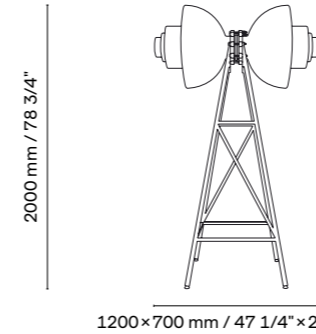

TRANSMISSION

by deFORM

Floor Lamp
CL019FA

Weight / 93 kg / 204,6 lbs
Primary Material /
Borosilicate Glass

LED G13 LED T8

Finishes / Metal Parts

Lacquered
Black Glossy

Certification /
CE, UL

Colors











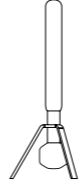



01

2000 mm / 78 3/4"

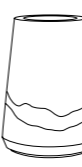
1200 x 700 mm / 47 1/4" x 27 9/16"

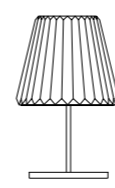
Table Lamps

From A to Z

 <p>650 mm / 25 9/16" Ø 310 mm / 12 3/16"</p>	<p>CIPHER by Yabu Pushelberg</p> <p>Table Lamp Large CL036TB</p> <p>Weight / 2,4 kg / 5 lbs Primary Material / Hand Blown Technical Glass</p> <p>LED CUSTOM</p>	<p>Finishes / Metal Parts Stainless Steel Titanium Champagne</p> <p>Certification / CE, UL, CCC</p>	<p>Colors 01 </p>
 <p>330 mm / 13" Ø 310 mm / 12 3/16"</p>	<p>CIPHER by Yabu Pushelberg</p> <p>Table Lamp Small CL036TA</p> <p>Weight / 2 kg / 3,3 lbs Primary Material / Hand Blown Technical Glass</p> <p>LED CUSTOM</p>	<p>Finishes / Metal Parts Stainless Steel Titanium Champagne</p> <p>Certification / CE, UL, CCC</p>	<p>Colors 01 </p>
 <p>200 mm / 7 7/8" 187 x 148 mm / 7 3/8" x 5 13/16"</p>	<p>CRYSTAL ROCK by Arik Levy</p> <p>Table Lamp CL017TA</p> <p>Weight / 3,5 kg / 7,7 lbs Primary Material / Hand Blown Cut Glass</p> <p>LED MODULE</p>	<p>Finishes / Metal Parts Lacquered Black Matt</p> <p>Certification / CE, UL, CCC</p>	<p>Colors 45  08  07  04 </p>
 <p>360 mm / 14 15/16" 135 x 265 mm / 5 5/16" x 10 7/16"</p>	<p>FLUX by Ed Ng & Terence Ngan</p> <p>Table Lamp CL034TA</p> <p>Weight / 10 kg / 22 lbs Primary Material / Hand Blown Glass</p> <p>LED CUSTOM</p> <p>✦</p>	<p>Finishes / Metal Parts Transparent Anodized Aluminium Alloy</p> <p>Certification / CE</p>	<p>Colors 01  Gold / Platina</p>
 <p>380 mm / 14 15/16" Ø 230 mm / 9 1/16"</p>	<p>GLITTERS by Gabriela Náhlíková</p> <p>Table Lamp CL001TA</p> <p>Weight / 8 kg / 17,6 lbs Primary Material / Crystal</p> <p>LED   E14 CE E12 UL</p>	<p>Finishes / Metal Parts Brushed Stainless Steel</p> <p>Certification / CE, UL, CCC</p>	<p>Colors 01 </p>

LOLLIPOP

by Boris Klimek

Table Lamp Glass BF
CLO25TA

Weight / 15 kg / 33 lbs
Primary Material /
Fused Color Glass

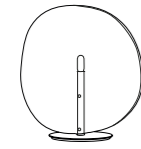

490 mm / 19 5/16"

540 mm / 21 1/4"

Finishes / Metal Parts

Lacquered White Matt

Certification /
CE

Colors

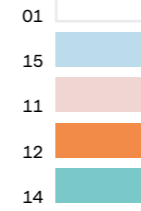

NEVERENDING GLORY

by Jan Plecháč & Henry Wielgus

La Scala Table Lamp
CLO08TC

Weight / 3 kg / 6,6 lbs
Primary Material /
Hand Blown Glass

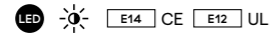

Ø 280 mm / 11"

250 mm / 9 13/16"

Finishes / Metal Parts

Lacquered White Matt

Certification /
CE, UL

Colors



SPACEY

by Lukáš Novák

Lunar Table Lamp
CLO94TA

Weight / 3,5 kg / 7,7 lbs
Primary Material /
Hand Blown Glass

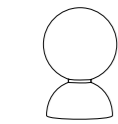
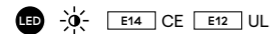

Ø 200 mm / 7 7/8"

295 mm / 11 5/8"

Finishes / Metal Parts

Polished Brass

Certification /
CE, UL

Colors



YAKISUGI

by Kengo Kuma

Table Lamp
CLO35TA

Weight / 5,2 kg / 11,5 lbs
Primary Material /
Hand Blown Glass

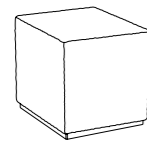

160 x 160 mm / 6 5/16" x 6 5/16"

182 mm / 7 3/16"

Finishes / Metal Parts

Brushed Stainless Steel

Certification /
CE

Colors



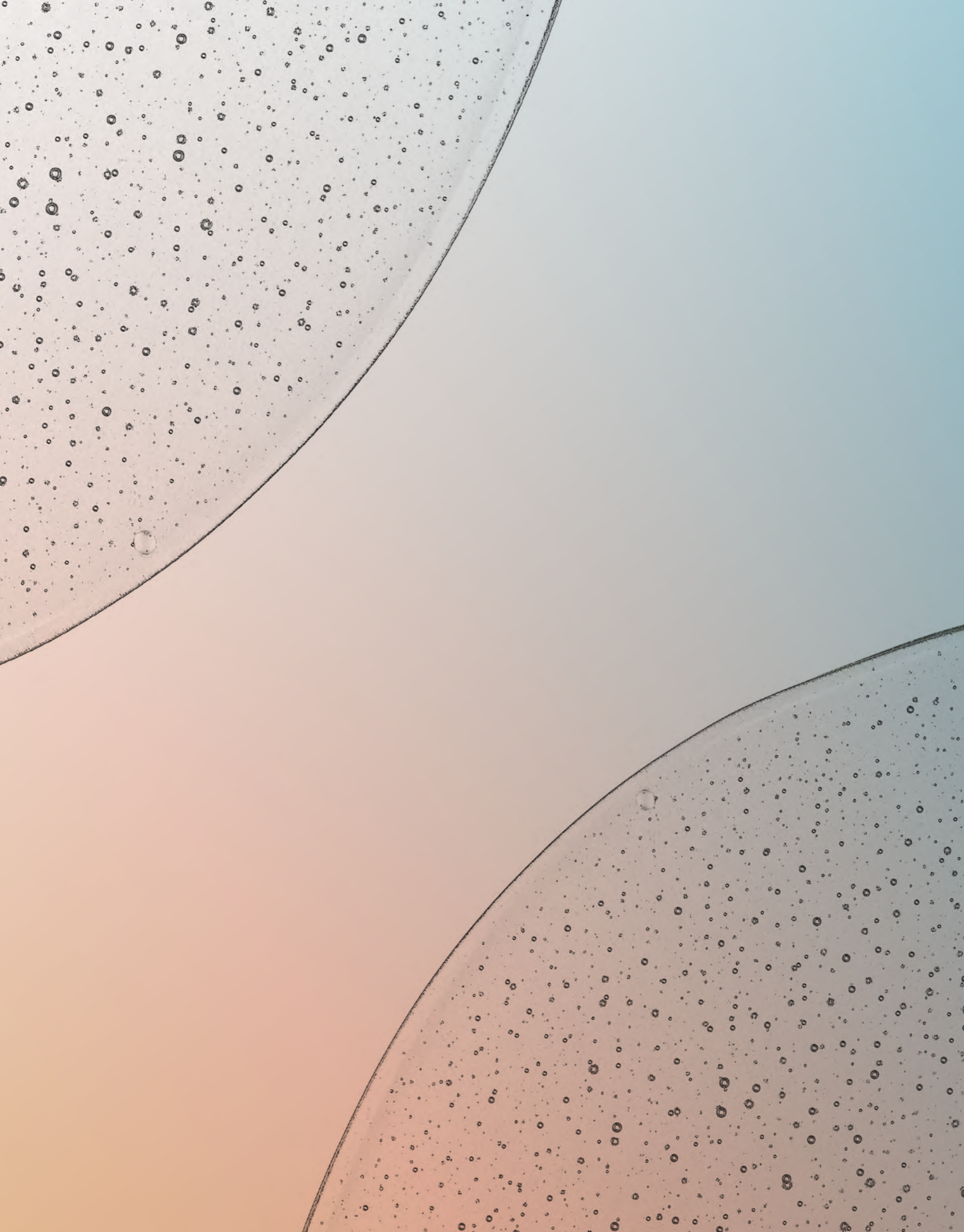

AULIX lighting

návrhy osvětlení a prodej svítidel
inteligentní systémy, vypínače

SVĚTELNÉ STUDIO

Náměstí Na Sádkách 705
252 41 Dolní Břežany (Praha západ)

Telefon: +420 246 083 152

Mobil.: +420 702 061 783

E-mail: studio@aulix.cz

Web: www.aulix.cz

E-shop: <http://obchod.aulix.cz>

Sledujte nás také na sociálních sítích:

