Interiérové osvětlení

Indoor
luminaires

AULIX lighting

návrhy osvětlení a prodej svítidel
inteligentní systémy, vypínače

SVĚTELNÉ STUDIO

Náměstí Na Sádkách 705
252 41 Dolní Břežany (Praha západ)

Telefon: +420 246 083 152

Mobil.: +420 702 061 783

E-mail: studio@aulix.cz

Web: www.aulix.cz

E-shop: <http://obchod.aulix.cz>

O nás 002

About us

Produkty 010

Products

Rejstřík 052

Index

Materiály 060

Materials

O nás

About us

.....
Firma 004

Company

.....
Návrhy osvětlení 006

Lighting design

.....
Zakázková výroba 008

Custom production

.....

Firma

Company

Jsmo ryze česká společnost, která působí na trhu svítidel již od roku 1997. Zlomovým okamžikem byl rok 2007, kdy jsme na trh uvedli první námi navržené a vyrobené svítidlo. Používáme vysoce kvalitní materiály, klademe důraz na jednotlivé detaily a precizní zpracování. Naše vize je navrhovat výrobky tak, abychom architektům, designérům či konečným uživatelům umožnili maximální variabilitu v řešení osvětlení rezidenčních a komerčních interiérů.

We are a 100% Czech company which has been in the lighting sector since 1997. A turning point came in 2007, when the first luminaire designed and manufactured by the company was put on the market. We use high-quality materials and place an emphasis on individual details and precision work. Our vision is to design products which offer architects, designers and end users maximum flexibility in planning the lighting of residential or commercial interiors.

Gustav Salinger
zakladatel, výkonný ředitel/founder, executive director



- 1997 ● Založení společnosti/Founding of the company
- 2004 ● Zahájení vývoje vlastních produktů/Initial development of our own products
- 2007 ● Vlastní kolekce uvedeny na trh/Introduction of our own collections
- 2009 ● Rozšíření výroby v Karlových Varech/Expansion of production in Karlovy Vary
- 2014 ● LOTUS, MERCUR, INFOS, TUBE - nové kolekce/new collections



Návrhy osvětlení

Lighting design

Návrhy interiérového osvětlení zpracováváme na míru každému zákazníkovi. Zohledňujeme světelné podmínky daného prostoru, címe design interiéru a dodáváme kompletní řešení včetně technické podpory. U náročnějších projektů nabízíme možnost zpracování fotorealistické 3d vizualizace.

We provide customized lighting design for every customer. We take into account the lighting conditions of the given space, respect the interior design, and deliver a comprehensive solution, including technical support. For more demanding projects, we also can provide photo-realistic 3D visualizations.

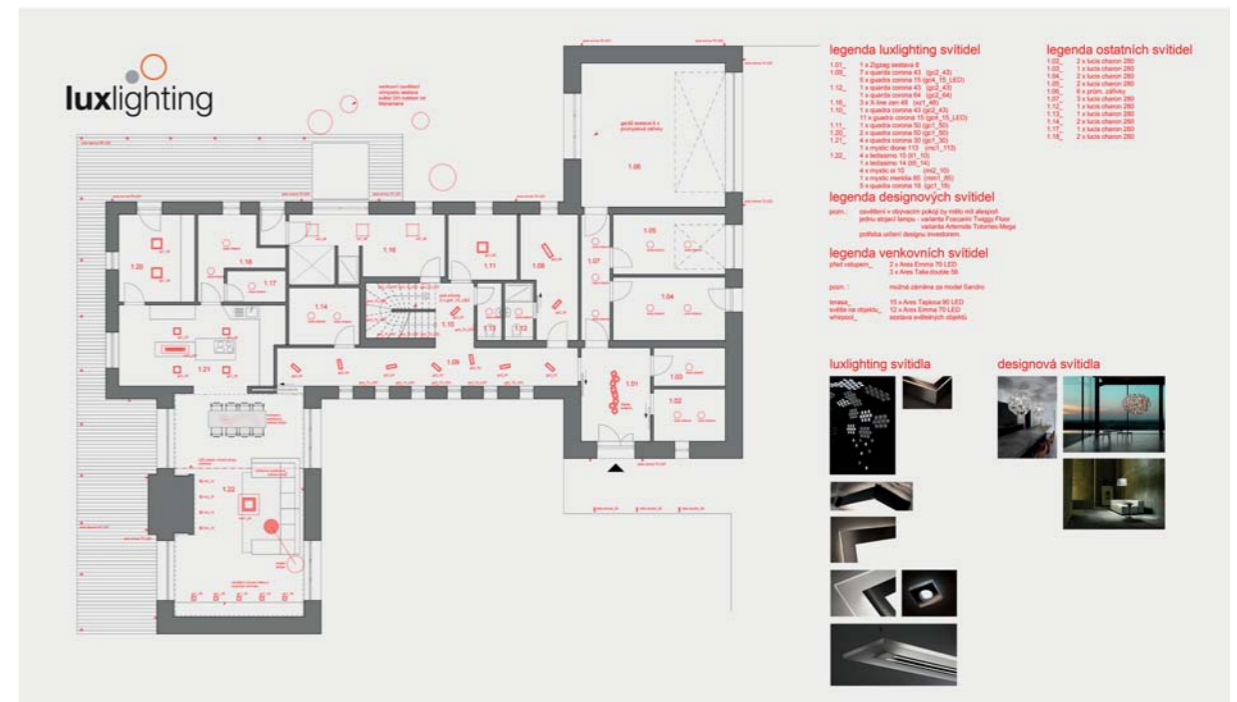
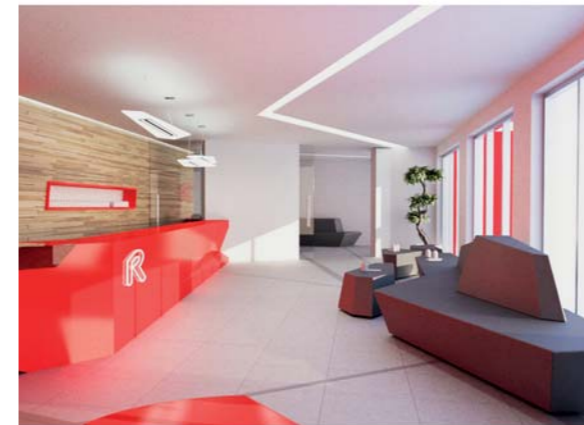

Zakázková výroba

Custom production

Kromě výroby z typických materiálů pro Luxlighting - Perspex®, broušený nerez, či leštěný hliník, nabízíme i zpracování unikátních solitérů z ručně tvarovaného skla. Díky kreativě při navrhování a spolupráci s šikovnými řemeslníky, dokážeme vyhovět i velmi atypickým požadavkům. Vývoj každého nového produktu je kombinací několika faktorů: základní myšlenka neboli obsah díla a jeho určení, správné pochopení vlastností použitého materiálu a také možnosti jeho zpracování. Nejinak je tomu i u skla. Sklo je svými optickými vlastnostmi přímo předurčené k výrobě svítidel. Při tepelném zpracování je k němu nutno přistupovat jako k organickému materiálu a dle toho hledat způsoby jeho tvarování. Snažíme se tento proces uchopit v jeho holé podstatě. Sklářské řemeslo je definované již po několik staletí. Propůjčujeme si tyto rozmanité techniky a aplikujeme je na funkční výrobky - svítidla, s přesahem do uměleckého objektu, jenž má svoji obsahovou hloubku a čisté umístění v architektonickém celku.

In addition to production using typical materials for Luxlighting such as Perspex® and polished aluminum, we can also work with unique pieces of hand-shaped glass. Thanks to our creative design team and skilled craftsmen, we're able to fill even the most demanding atypical orders. The development of every new product is a combination of several factors: the basic concept or nature of the work and what it is intended for, the proper understanding of the properties of the material used, and the manners in which it can be worked. It's no different with glass. Because of its optical properties, glass is ideal for producing lighting fixtures. When working with heated glass, it must be treated as an organic material, giving insight into ways of shaping it. We try to grasp the very essence of this process. The art of glassmaking has been refined for centuries. We borrow many diverse techniques and apply them to functional products - luminaires, as well as art objects, which have an integral place within the world of architecture.



MgA. Martin Tocháček
designér

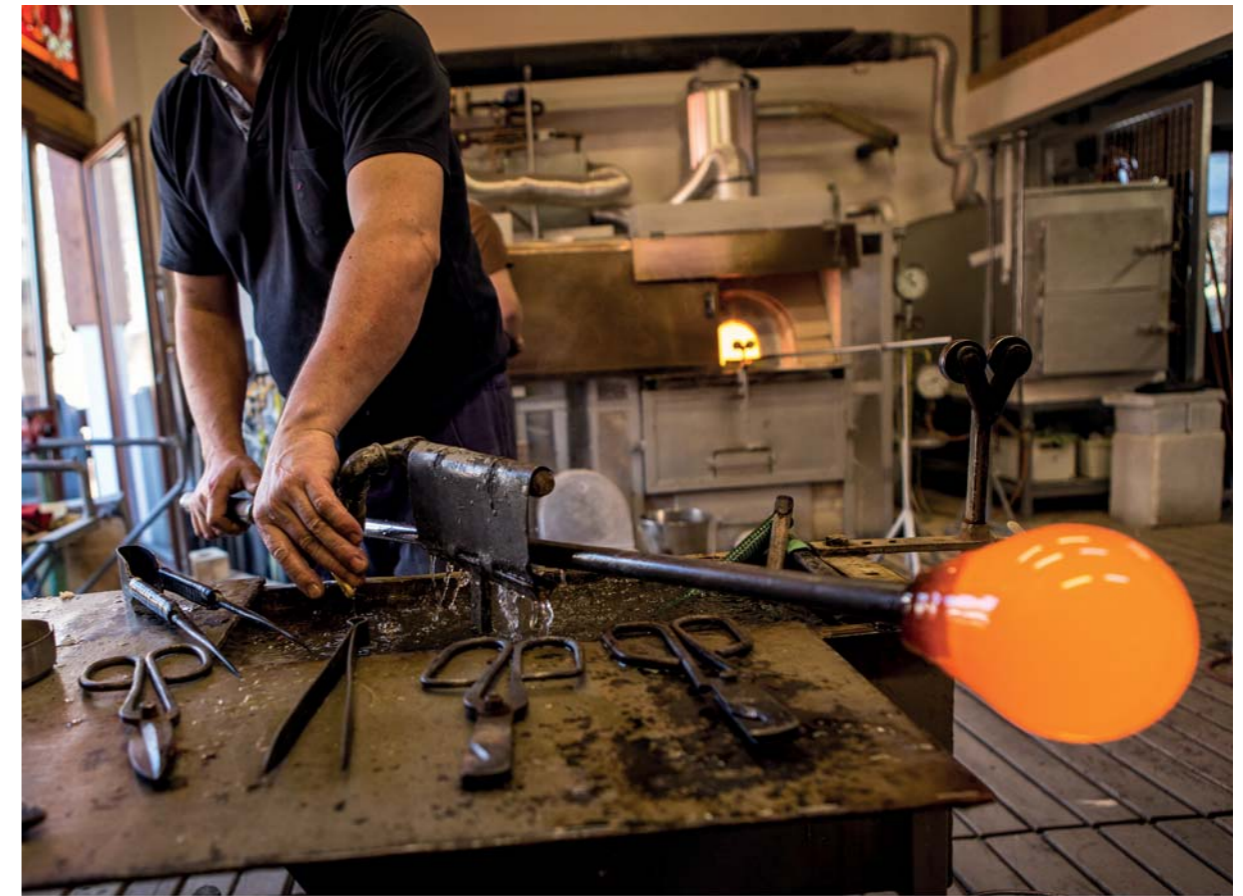

Produkty

Products

Vysvětlivky / Descriptions		012
uni.body		014
quadra	corona	016
	silky	018
retro	corona	020
	silky	022
zig zag		024
up	corona	026
mystic	meridia	028
	dione	030
	methis	032
	io	034
x-line	zen	036
	color	038
ledissimo	direct	040
	indirect	042
lotus		044
tube		046
mercur		048
infos		050













Vysvětlivky

Descriptions

Provedení/Finish

- | | | |
|---|--|---|
|  .00 broušený nerez
brushed stainless steel |  .05 černá
black |  .10 žlutá
yellow |
|  .01 leštěný nerez
polished stainless steel |  .06 červená
red |  .11 fialová
purple |
|  .02 eloxovaný hliník
anodized aluminium |  .07 zelená
green |  .12 oranžová
orange |
|  .03 RAL barva dle výběru
RAL color of your choice |  .08 modrá
blue |  .13 bílá/stříbrná
white/silver |
|  .04 bílá
white |  .09 růžová
pink |  .14 bílá/zlatá
white/gold |

Vlastnosti/Features

- | | |
|--|--|
|  vestavné nástěnné
wall mount |  LED zdroj
LED light source |
|  vestavné stropní
ceiling mount |  nutnost 12V trafo
12V transformer required |
|  přisazené nástěnné
surface wall mount |  montáž do elektroinstalační krabice
installation in an electrical box |
|  přisazené stropní
surface ceiling mount |  elektronický předřadník
electronic ballast |
|  závěsné, přímý zdroj
suspended - direct lighting |  ochranná folie na kovovém povrchu
protective foil on the metal surface |
|  závěsné, nepřímý zdroj
suspended - indirect lighting |  patentovaný magnetický systém
patented magnetic system |
|  závěsné, přímý & nepřímý zdroj
suspended, direct & indirect lighting | |

Volitelné/Optional

-  **stmívání**
dimming
-  **LED v provedení RGB**
LED in RGB version
-  **krytí proti vlhkosti IP44**
IP44 moisture protection

Rozměry/Dimensions

- | | |
|-----|---------------------------------------|
| 200 | vnější část
outer part |
| 200 | vestavná část
recessed part |

uni.body

Univerzální zápné tělo uni.body tvoří jádro několika kolekcí. Pečlivě navržená konstrukce těla z lakovaného plechu umožňuje velmi jednoduchou instalaci a údržbu, v neposlední řadě pak poskytuje uživateli svobodu výběru. Pomocí patentovaného magnetického systému je totiž možné zápné tělo osadit krytem z vybrané kolekce, případně si nechat vyrobit na zakázku tvar dle vlastního návrhu.

The universal recessed uni.body is the heart of several collections. Carefully designed construction using lacquered sheet metal makes for easy installation and maintenance, and also gives the user freedom of choice. Using a patented magnetic system, it is possible to mount a cover from the collection of your choice over the recessed fixture, or possibly custom order one of your own design.

uni.body

- 1
zarážky/stoppers
- 2
šrouby/screws
- 3
vymezovací trny/spacers

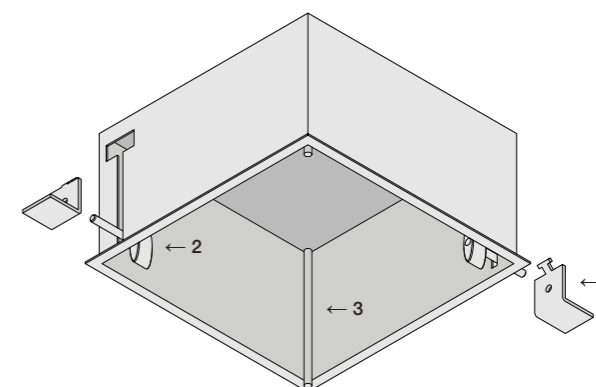

←
uni.body
150x150x90

kompatibilní kolekce/compatible collections

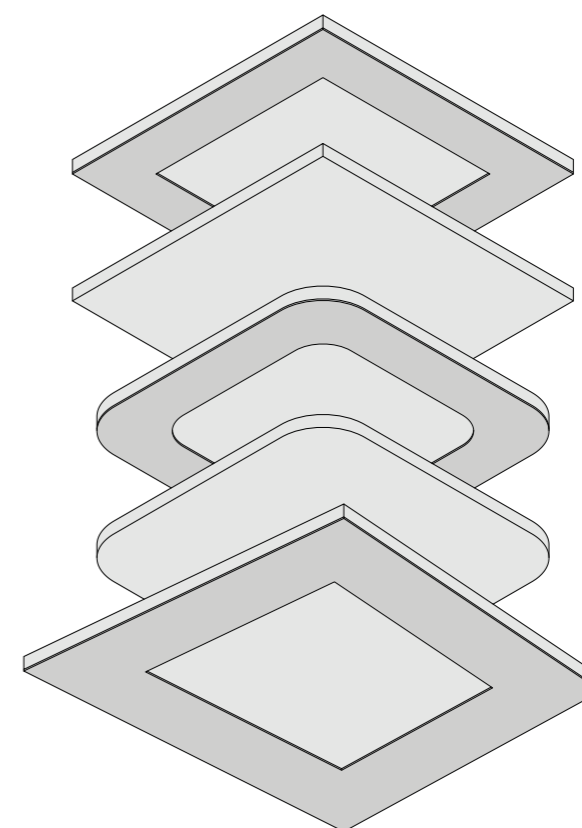

←
quadra
corona 18

←
quadra
silky 18

←
retro
corona 18

←
retro
silky 18

←
zig zag
22

quadra corona



quadra corona 95

quadra corona 50

quadra corona 30

quadra corona 18

quadra corona 14

12095.00

12050.00

12030.00

12018.00

12014.00

výzbroj/equipment
4x 39 W T5 G5

výzbroj/equipment
4x 36 W TC-L 2G11
8040 lm LED

výzbroj/equipment
2x 24 W TC-F 2G10
2010 lm LED

výzbroj/equipment
1x 18 W TC-F 2G10
2000 lm LED

výzbroj/equipment
2x 15 W E27

napětí/voltage
230 V

napětí/voltage
230 V

napětí/voltage
230 V

napětí/voltage
230 V

napětí/voltage
230 V

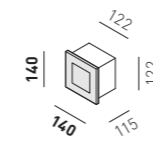
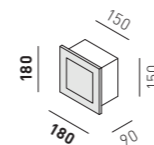
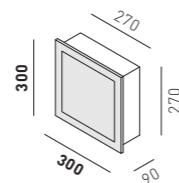
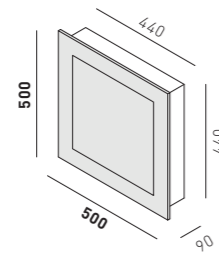
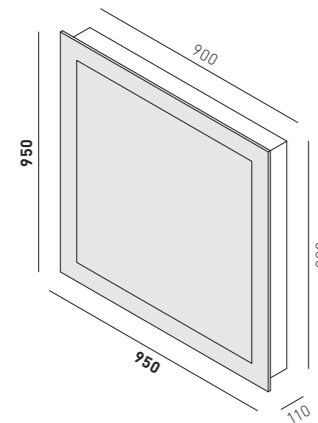

quadra corona 64

quadra corona 43

12064.00

12043.00

výzbroj/equipment
1x 55 W TC-L 2G11
4134 lm LED

výzbroj/equipment
1x 24 W TC-L 2G11
2756 lm LED

napětí/voltage
230 V

napětí/voltage
230 V

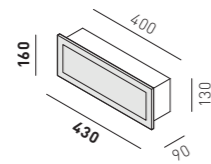
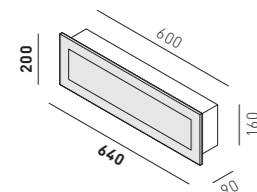

quadra LED corona 15

12015.00

výzbroj/equipment
1,5 W LED

napětí/voltage
12 V DC

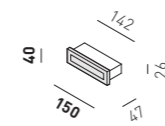

quadra LED corona 8

12008.00

výzbroj/equipment
1 W LED

napětí/voltage
12 V DC

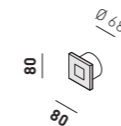

Provedení/Finish: .00 .01 .02

Kolekce quadra corona využívá systému univerzálních vestavných těl uni.body a patentovaného magnetického uchycení krytu z akrylátového skla Perspex®. Měkké světlo vycházející zpod krycího rámečku vytváří působivý efekt korony.

The quadra corona collection uses a system of universal recessed uni.body fixtures and patented magnetic mounts for Perspex® acrylic glass covers. The soft light coming from under the cover frame creates an impressive corona effect.



quadra silky



quadra silky 50

quadra silky 30

quadra silky 18

quadra silky 14

14050.00**14030.00****14018.00****14014.00**

výzbroj/equipment
4x 36 W TC-L 2G11
8040 lm LED

napětí/voltage
230 V

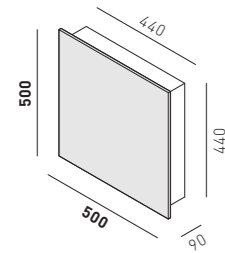

výzbroj/equipment
2x 24 W TC-F 2G10
2010 lm LED

napětí/voltage
230 V

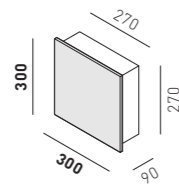

výzbroj/equipment
1x 18 W TC-F 2G10
2000 lm LED

napětí/voltage
230 V

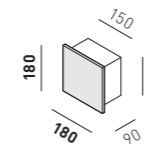

výzbroj/equipment
2x 15 W E27

napětí/voltage
230 V

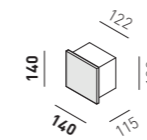

quadra silky 64

quadra silky 43



quadra LED silky 15



quadra LED silky 8

14064.00**14043.00****14015.00****14008.00**

výzbroj/equipment
1x 55 W TC-L 2G11
4134 lm LED

napětí/voltage
230 V

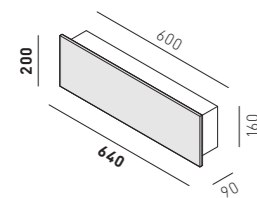

výzbroj/equipment
1x 24 W TC-L 2G11
2756 lm LED

napětí/voltage
230 V

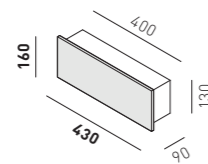

výzbroj/equipment
1,5 W LED

napětí/voltage
12 V DC

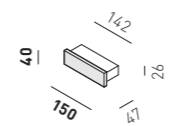

výzbroj/equipment
1 W LED

napětí/voltage
12 V DC



Magnetický kryt svítidel z matného akrylátového kolekce quadra silky není osazen viditelným kovovým rámečkem, vytváří tak minimalistickou alternativu ke kolekci quadra corona.

The magnetic fixture cover of the quadra silky collection is made of frosted acrylic and doesn't have any metal frame, thus creating a minimalist alternative to the quadra corona collection.

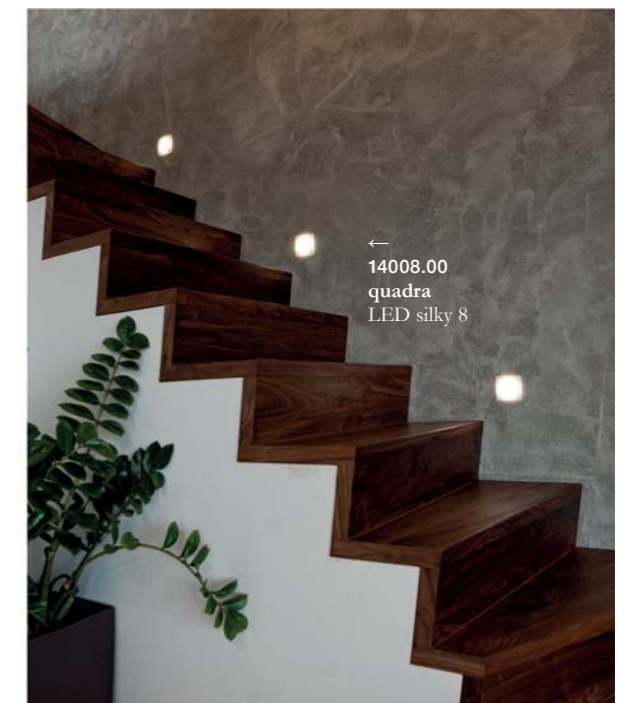

retro corona



retro corona 110

15110.00

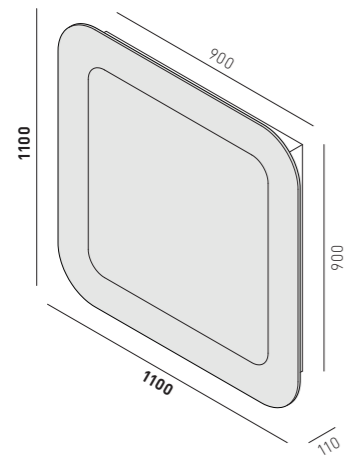
výzbroj/equipment
4x39 W T5 G5napětí/voltage
230 V

retro corona 14

15014.00

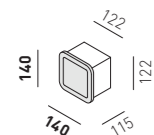
výzbroj/equipment
2x 15 W E27napětí/voltage
230 V

retro corona 54

15054.00

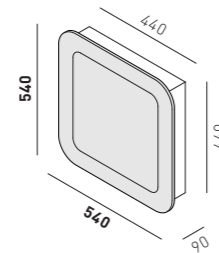
výzbroj/equipment
4x36 W TC-L 2G11
8040 lm LEDnapětí/voltage
230 V

retro LED corona 8

15008.00

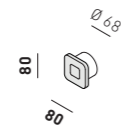
výzbroj/equipment
1 W LEDnapětí/voltage
12 V DC

retro corona 32

15032.00

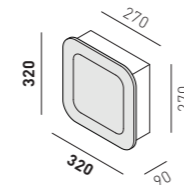
výzbroj/equipment
2x 24 W TC-F 2G10
2010 lm LEDnapětí/voltage
230 V

retro corona 18

15018.00

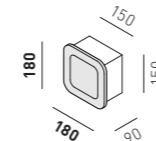
výzbroj/equipment
1x 18 W TC-F 2G10
2000 lm LEDnapětí/voltage
230 V

Provedení/Finish: .00 .01 .02

Kolekce retro corona využívá stejně jako kolekce quadra systému univerzálních vestavných těl uni.body a patentovaného magnetického uchycení krytu z akrylátového skla Perspex®. Zaoblené rohy krytu působí svěžím retro dojmem.

Like the quadra collection, the retro corona collection uses a system of universal recessed uni.body fixtures and patented magnetic mounts for Perspex® acrylic glass covers. The rounded corners of the cover create a fresh retro feel.



retro silky



retro silky 54

retro silky 32

retro silky 18

retro silky14

17054.00**17032.00****17018.00****17014.00**

výzbroj/equipment
4x36 W TC-L 2G11
8040 lm LED

napětí/voltage
230 V

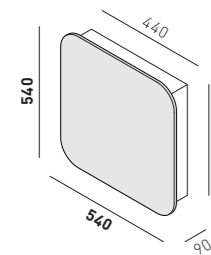

výzbroj/equipment
2x 24 W TC-F 2G10
2010 lm LED

napětí/voltage
230 V

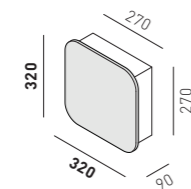

výzbroj/equipment
1x 18 W TC-F 2G10
2000 lm LED

napětí/voltage
230 V

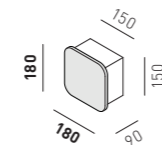

výzbroj/equipment
2x 15 W E27

napětí/voltage
230 V

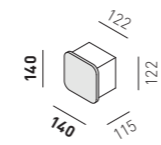

retro LED silky 8

17008.00

výzbroj/equipment
1 W LED

napětí/voltage
12 V DC

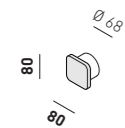

Magnetický kryt svítidel z matného akrylátového kolekce retro silky není osazen viditelným kovovým rámečkem, vytváří tak minimalistickou alternativu ke kolekci retro corona.

The magnetic fixture cover of the retro silky collection is made of frosted acrylic and doesn't have any metal frame, thus creating a minimalist alternative to the retro corona collection.

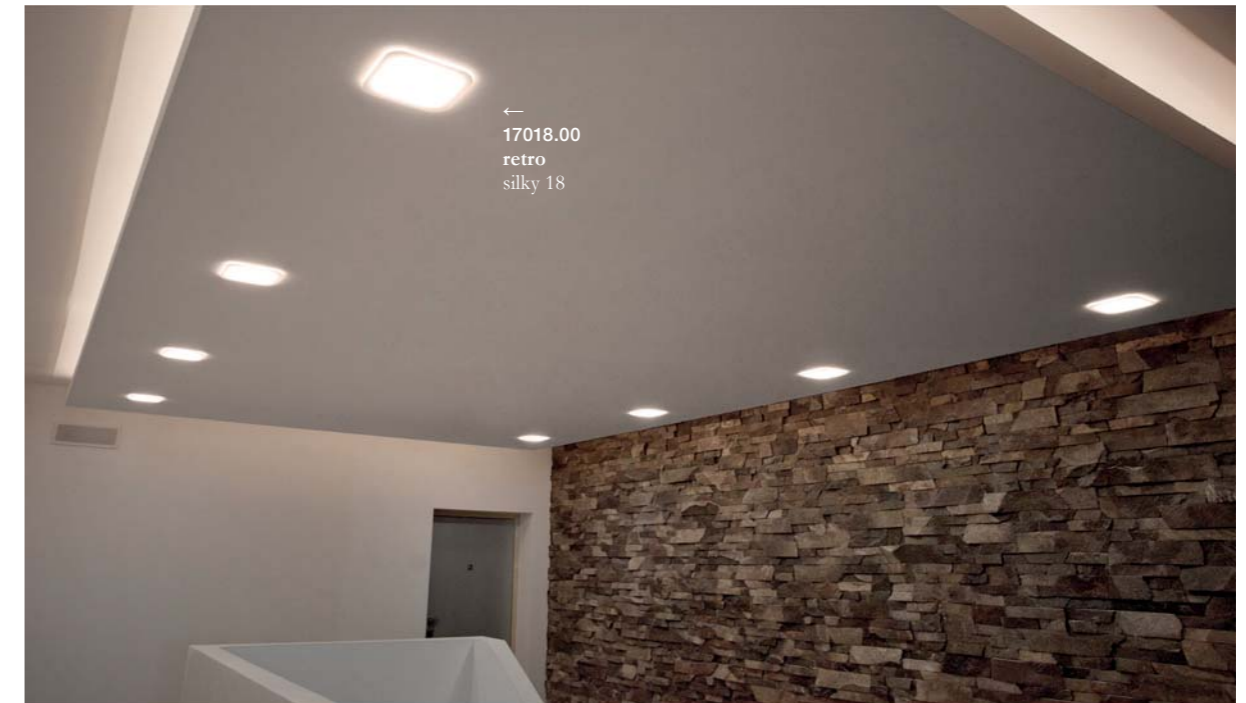

zig zag



zig zag 128

18128.00

výzbroj/equipment
4x 39 W T5 G5

napětí/voltage
230 V

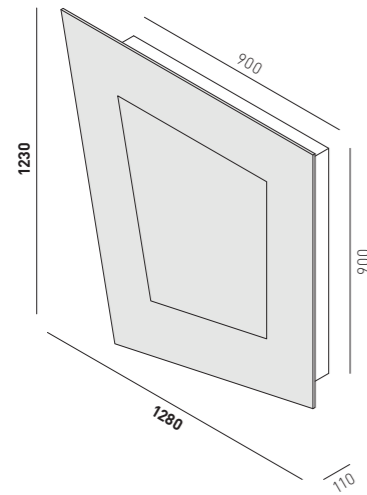

zig zag 72

18072.00

výzbroj/equipment
4x 36 W TC-L 2G11
8040 lm LED

napětí/voltage
230 V

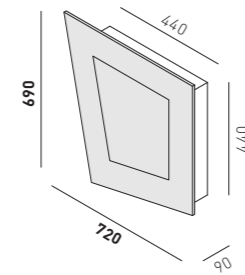

zig zag 44

18044.00

výzbroj/equipment
2x 24 W TC-F 2G10
2010 lm LED

napětí/voltage
230 V

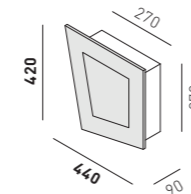

zig zag 22

18022.00

výzbroj/equipment
1x 18 W TC-F 2G10
2000 lm LED

napětí/voltage
230 V

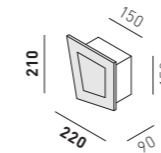

zig zag LED 10

18010.00

výzbroj/equipment
1 W LED

napětí/voltage
12 V DC

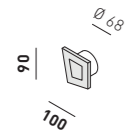

Ukázka kompozice/Sample composition

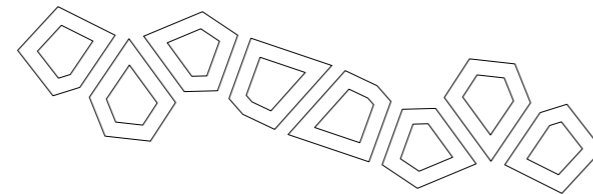

Provedení/Finish: .00 .01 .02

Hlavní předností kolekce zig zag je rozmanitost. Kryty jednotlivých svítidel se vyrábí vždy v několika tvarových variantách, což umožňuje vytvářet působivé, hravé a originální kompozice.

The main advantage of the zig zag collection is variety. The covers of individual lights are always produced in several different shapes, giving a playful impression of originality.



→
18022.00
zig zag
22

up corona



up corona 95

up corona 50

up corona 35

up corona 20

19095.00

19050.00

19035.00

19020.00

výzbroj/equipment
4x39 W T5 G5

výzbroj/equipment
4x36 W TC-L 2G11
8040 lm LED

výzbroj/equipment
2x 36 W TC-F 2G10
3007 lm LED

výzbroj/equipment
1x 24 W TC-F 2G10
2000 lm LED

napětí/voltage
230 V

napětí/voltage
230 V

napětí/voltage
230 V

napětí/voltage
230 V

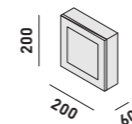
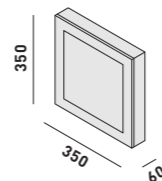
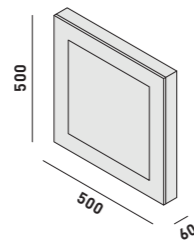
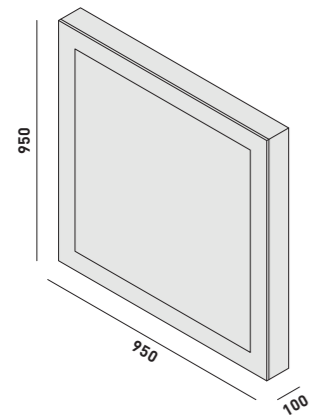

up corona 62

up corona 40



up LED corona 10

19062.00

19040.00

19010.00

výzbroj/equipment
1x 55 W TC-L 2G11
4134 lm LED

výzbroj/equipment
1x 24 W TC-L 2G11
2756 lm LED

výzbroj/equipment
4 W power LED

napětí/voltage
230 V

napětí/voltage
230 V

napětí/voltage
230 V

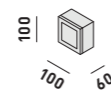
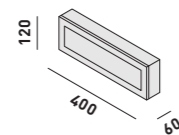
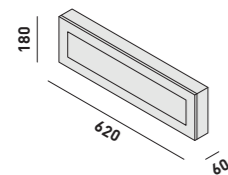

Provedení/Finish: .00 .01 .02

Pro minimalistickou kolekci up je charakteristické precizní zpracování montury z kartáčované nerez oceli a krytu z akrylátového skla se systémem magnetického uchycení.

This minimalist collection is characterized by a precision-crafted brushed stainless steel mount and acrylic glass cover with magnetic mounts.



mystic meridia



mystic meridia 85

mystic meridia 65

mystic meridia 55

22085.00**22065.00****22055.00**

výzbroj/equipment
4x 24 W TC-L 2G11
8008 lm LED

napětí/voltage
230 V

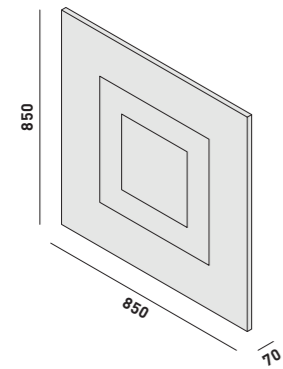

výzbroj/equipment
1x 55 W T16-R 2Gx13
4004 lm LED

napětí/voltage
230 V

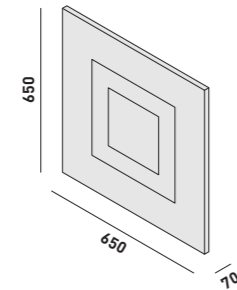

výzbroj/equipment
1x 55 W T16-R 2Gx13
4004 lm LED

napětí/voltage
230 V

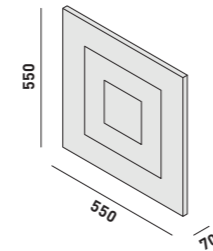

Provedení/Finish: .00 .01 .02

Exkluzivní stropní přisazená svítidla z kolekce mystic meridia poskytují jemné a měkké osvětlení. Charakteristickým prvkem kolekce je 20 milimetrů silný kryt z akrylátového skla v matné úpravě.

The exclusive surface ceiling mount lights of the mystic meridia collection provide subtle, soft lighting. The hallmark of the collection is the 20 mm thick cover made of frosted acrylic glass.

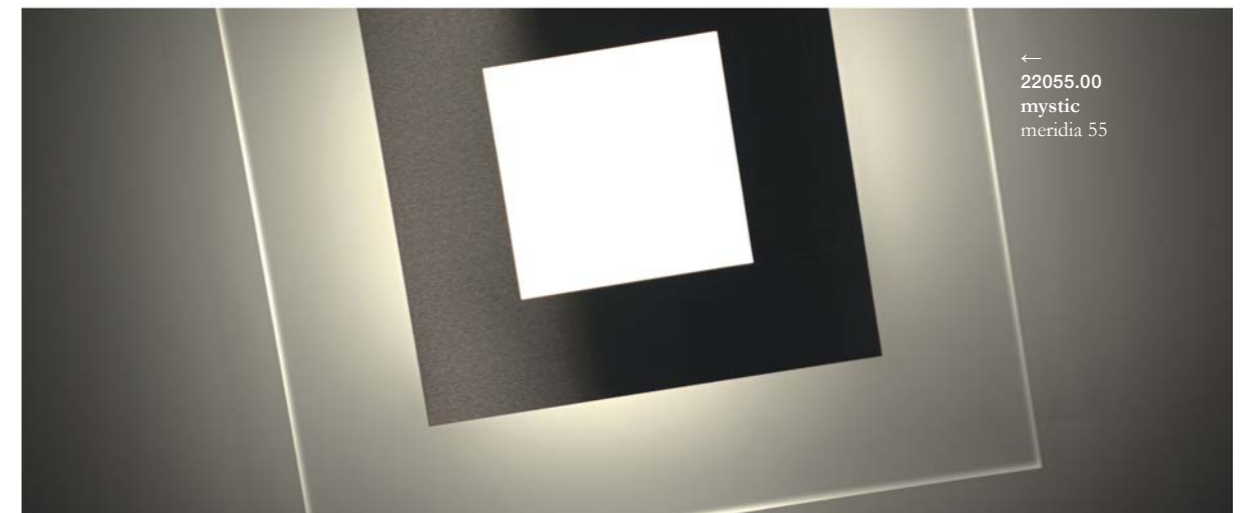
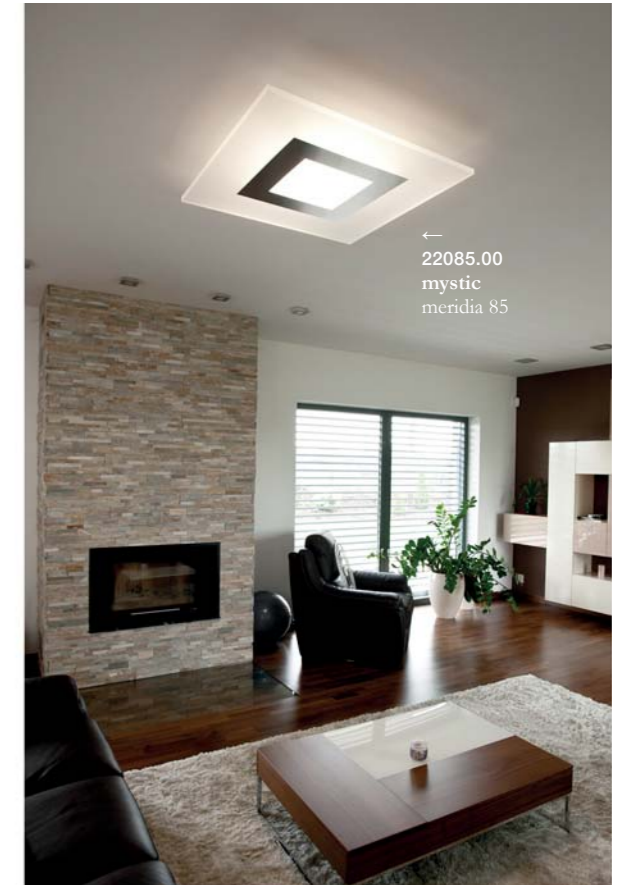

mystic dione



mystic dione 150+LED

22150.00+LED

výzbroj/equipment
2x 39 W T5 G5 + LED 15 W

napětí/voltage
230 V



mystic dione 150

22150.00

výzbroj/equipment
2x 39 W T5 G5

napětí/voltage
230 V

mystic dione 113

22113.00

výzbroj/equipment
2x 39 W T5 G5

napětí/voltage
230 V

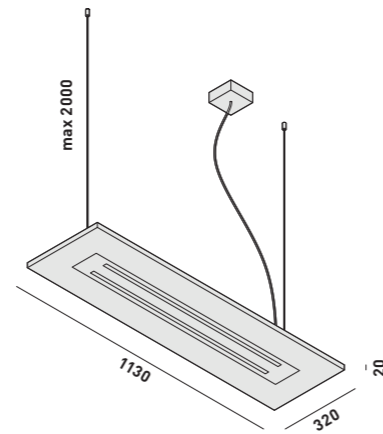
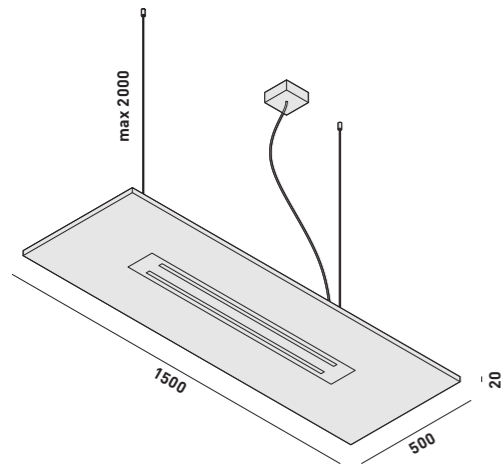

Lustry z kolece mystic dione nabízí minimalistický design, dokonalé zpracování a vyvážený poměr přímého a nepřímého osvětlení.

The chandeliers of the mystic dione collection feature a minimalist design, excellent craftsmanship, and a fine balance between direct and indirect lighting.

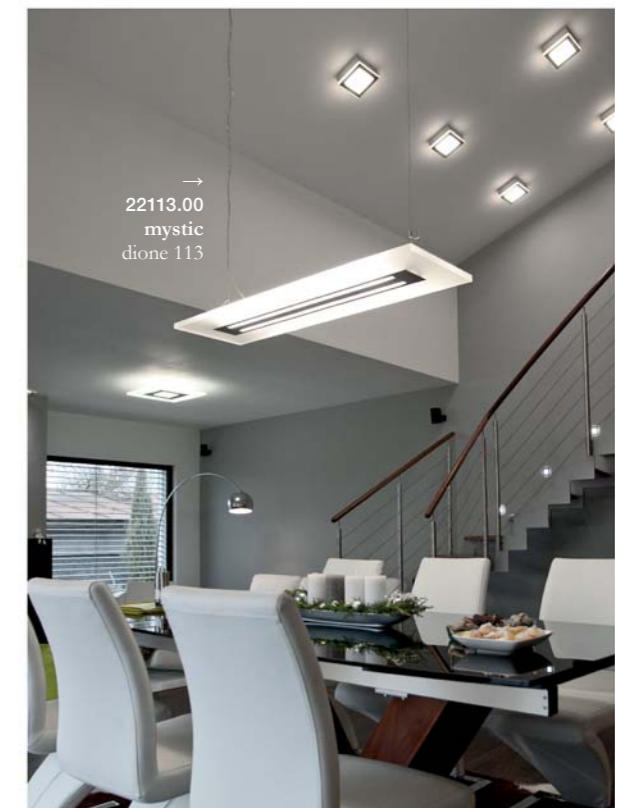

Provedení/Finish: .00 .01 .02

mystic metis



mystic metis 128

mystic metis 98

mystic metis 68

mystic metis 32

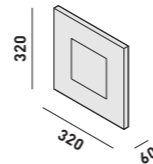
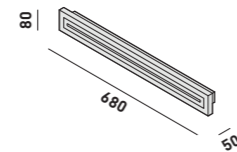
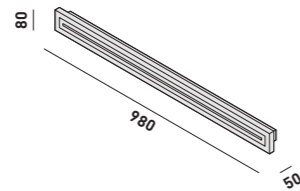
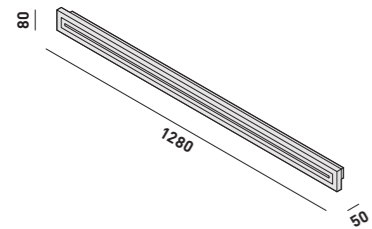
22128.00**22098.00****22068.00****22032.00**výzbroj/equipment
1x 28 W SLS G5výzbroj/equipment
1x 21 W SLS G5výzbroj/equipment
1x 24 W SLS G5výzbroj/equipment
1x 16 W CF-L GR10q
200 lm LEDnapětí/voltage
230 Vnapětí/voltage
230 Vnapětí/voltage
230 Vnapětí/voltage
230 V

Svítlidla z kolekce mystic metis je možné upevnit jak na strop, tak na stěnu. Charakteristickým prvkem kolekce je 20 mm silný kryt z akrylátového skla v matné úpravě.

Luminaires from the mystic metis collection can be mounted on both ceilings and walls. The hallmark of the collection is the 20 mm thick cover made of frosted acrylic glass.



Provedení/Finish: **.00** **.01** **.02**

mystic io



mystic io 10

mystic io 11

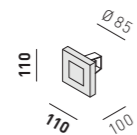
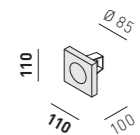
22010.00**22011.00**výzbroj/equipment
8 W Power LEDvýzbroj/equipment
8 W Power LEDnapětí/voltage
230 Vnapětí/voltage
230 V

Bodové svítidlo mystic io poskytuje díky 8 W LED modulu dostatek světla i vzhledem ke své velikosti. Kryt svítidla je tvořen 20 mm silnou deskou z akrylátového skla v matné úpravě doplněné nerez stínidlem.

Thanks to its 8 W LED module, the mystic io spotlight system offers plenty of light, despite its size. Light fixtures are covered with a 20 mm thick plate of frosted acrylic glass with a stainless steel shade.



Provedení/Finish:

.00

.01

.02

x-line zen



x-line zen 48

x-line zen 37

x-line zen 18

23548.____

výzbroj/equipment
2x 24 W TC-L 2G11
3007 lm LED

napětí/voltage
230 V

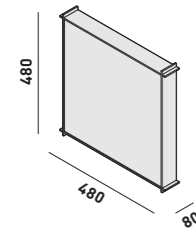
**23537.____**

výzbroj/equipment
2x 18 W TC-L 2G11
2010 lm LED

napětí/voltage
230 V

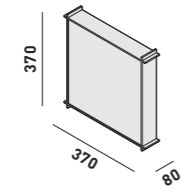
**23518.____**

výzbroj/equipment
1x 24 W TC-L 2G11
1378 lm LED

napětí/voltage
230 V

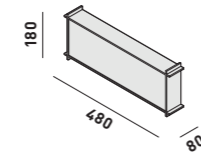

Svítlidla x-line zen jsou vyráběna v černé a bílé barvě ve vysokém lesku. Charakteristickým znakem této kolekce je vtipná a jednoduchá konstrukce, decentní osvětlení stropu a neotřelý originální design.

X-line zen luminaires come in high gloss black or white. This collection is distinguished by its simple and clever construction, subtle ceiling light, and novel design.

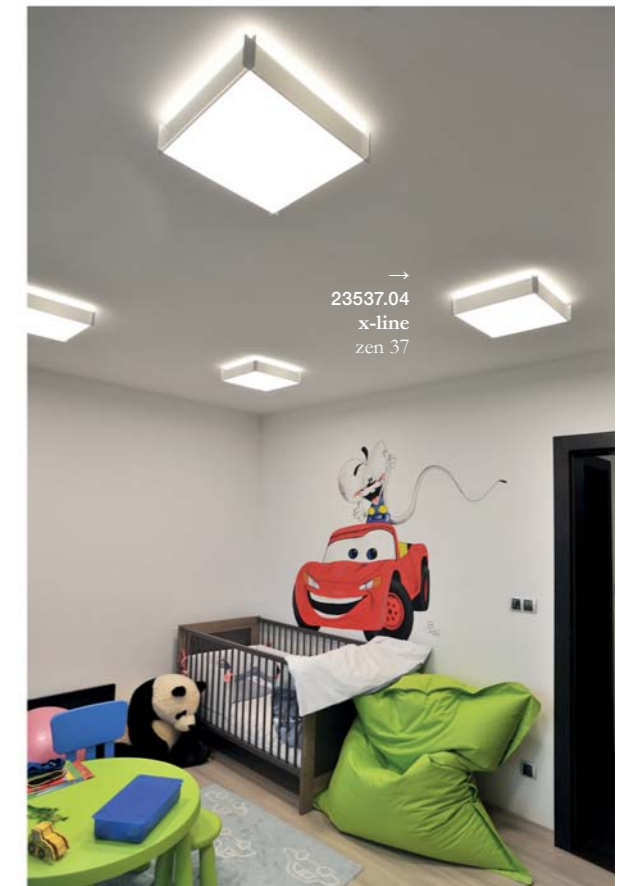
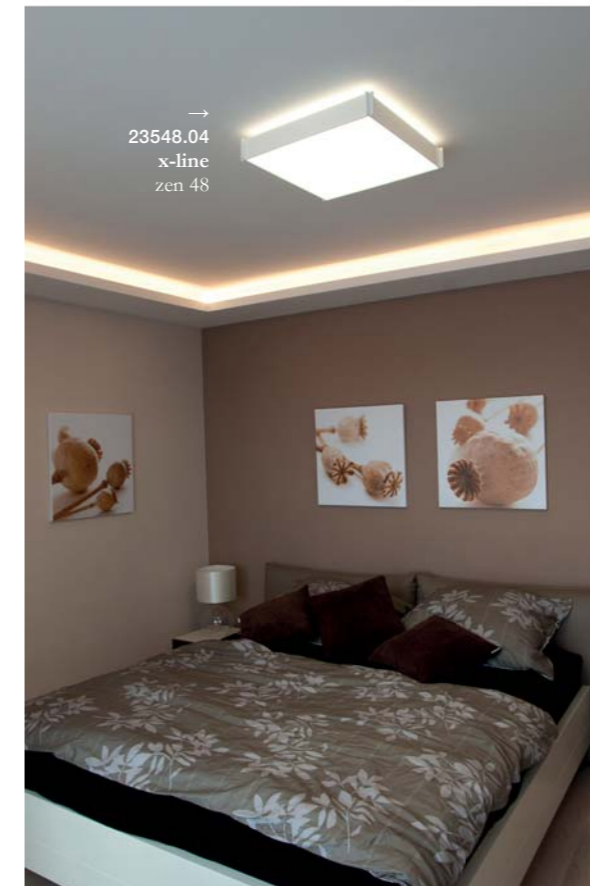

Provedení/Finish:

.04 .05

x-line color



x-line color 48

x-line color 37

x-line color 18

23048.____

výzbroj/equipment
2x 24 W TC-L 2G11
3007 lm LED

napětí/voltage
230 V

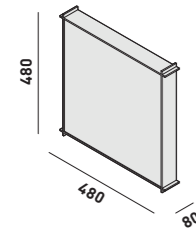
**23037.____**

výzbroj/equipment
2x 18 W TC-L 2G11
2010 lm LED

napětí/voltage
230 V

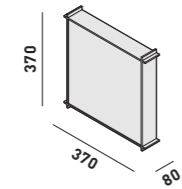
**23018.____**

výzbroj/equipment
1x 24 W TC-L 2G11
1378 lm LED

napětí/voltage
230 V

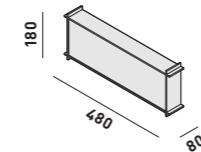

Provedení/Finish:



Svítlidla x-line color září barvami. Tělo svítidla je sestaveno z barevných desek z akrylátové skla Perspex®, v nabídce je sedm barevných variant. Dalším charakteristickým znakem této kolekce je vtipná a jednoduchá konstrukce.

X-line color luminaires radiate color. The light fixture is made of colored plates of Perspex® acrylic glass, and the line offers a total of seven color variations. Another distinguishing feature of the collection is its simple and clever construction.



ledissimo direct



ledissimo direct 22

24022.00

výzbroj/equipment
22x 2 W LED

napětí/voltage
230 V

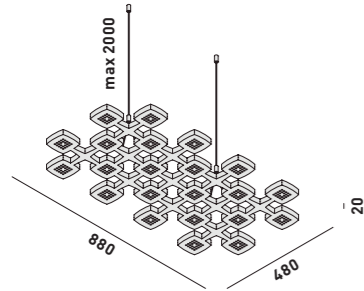

ledissimo direct 13

24013.00

výzbroj/equipment
13x 2 W LED

napětí/voltage
230 V

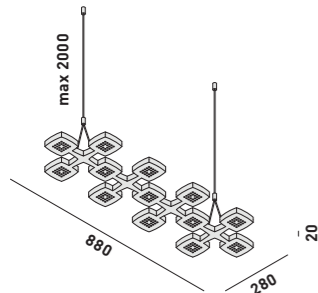

ledissimo direct 17

24017.00

výzbroj/equipment
17x 2 W LED

napětí/voltage
230 V

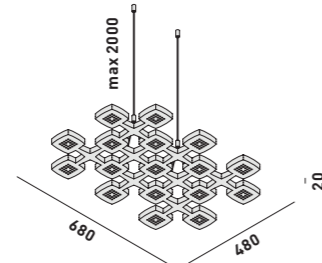

ledissimo direct 10

24010.00

výzbroj/equipment
10x 2 W LED

napětí/voltage
230 V

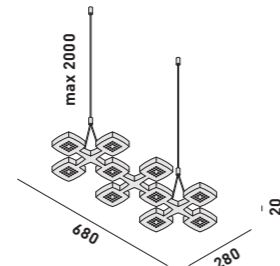

ledissimo direct 14

24014.00

výzbroj/equipment
14x 2 W LED

napětí/voltage
230 V

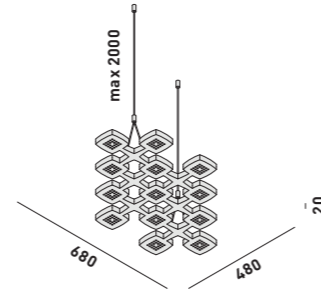

Lustry ledissimo direct nabízí unikátní design a širokou variabilitu tvarů. Kombinací těchto svítidel lze vytvořit působivé prostorové sestavy. Pro tuto kolekci jsou LED zdroje vyráběny speciálně na zakázku.

Ledissimo direct chandeliers offer a unique design and wide variety of shapes. Impressive spatial effects can be created using combinations of these lights. LED light sources can be custom ordered for this collection.

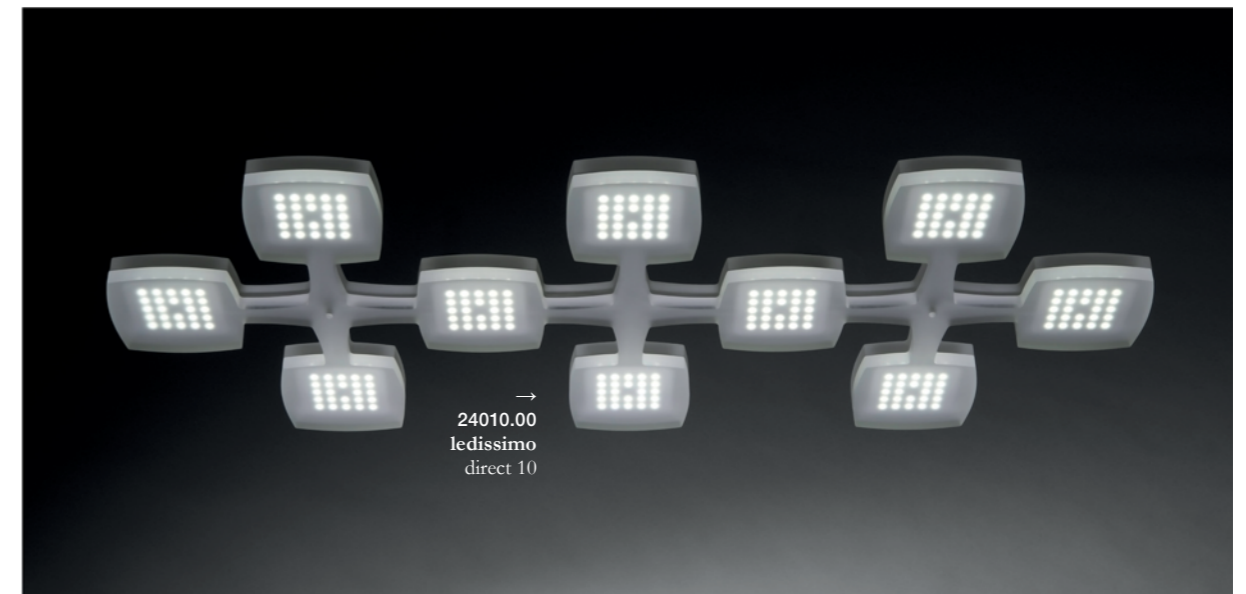

ledissimo indirect



ledissimo indirect 22

24122.00

výzbroj/equipment
22x 2 W LED

napětí/voltage
230 V

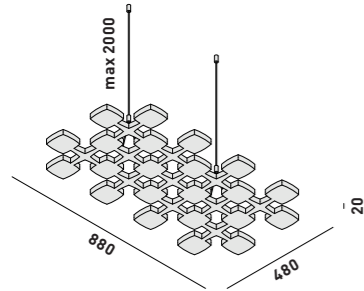

ledissimo indirect 13

24113.00

výzbroj/equipment
13x 2 W LED

napětí/voltage
230 V

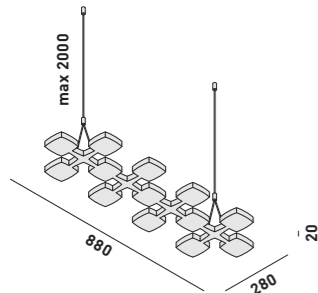

ledissimo indirect 17

24117.00

výzbroj/equipment
17x 2 W LED

napětí/voltage
230 V

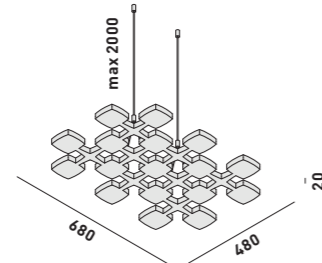

ledissimo indirect 10

24110.00

výzbroj/equipment
10x 2 W LED

napětí/voltage
230 V

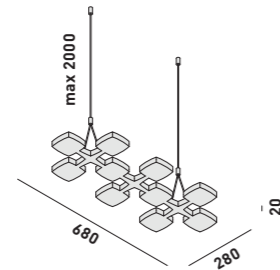

ledissimo indirect 14

24114.00

výzbroj/equipment
14x 2 W LED

napětí/voltage
230 V

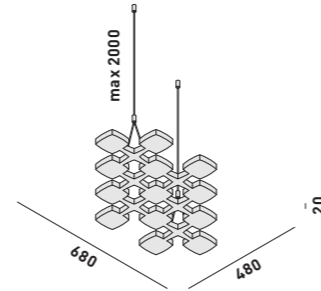

Lustry z kolekce ledissimo indirect vytváří intimní a měkké nepřímé osvětlení. Stejně jako v případě sesterské kolekce ledissimo direct je možné vytvářet originální prostorové kompozice z několika rozměrových variant.

Ledissimo indirect chandeliers create intimate and soft indirect lighting. Just like their sister collection ledissimo direct, it is possible to create original spatial compositions by using several different-sized fixtures.



lotus



lotus 125

lotus 85

50125.____

50085.____

výzbroj/equipment
129 W LED

výzbroj/equipment
116 W LED

napětí/voltage
230 V

napětí/voltage
230 V

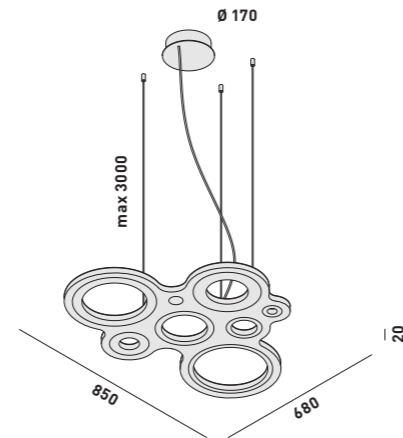
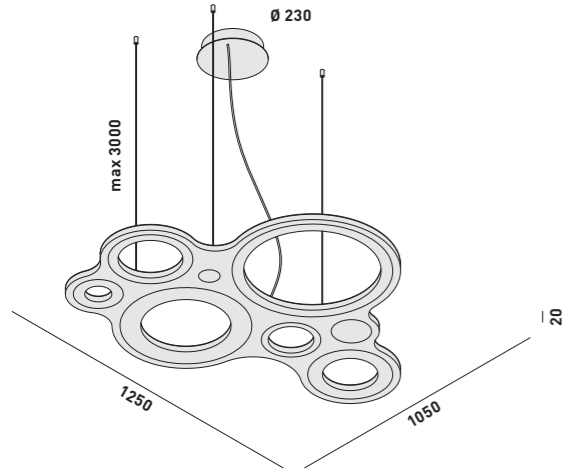

Design svítidla Lotus se všemi závěsnými lankami a přívodními kabely lze chápat jako analogii vodních rostlin se svými kruhovými listy na hladině a soustavou stonků pod ní. Díky dvěma velikostním variantám pak lze vytvářet rozsáhlé, závěsné či nástěnné, přirozeně na sebe navazující struktury.

The design of Lotus lights with their hanging lines and power cables can be compared to water plants with their round leaves on the surface and stems below. As there are two different sizes, it is possible to create extensive hanging or wall-mounted structures which naturally tie in to one another.

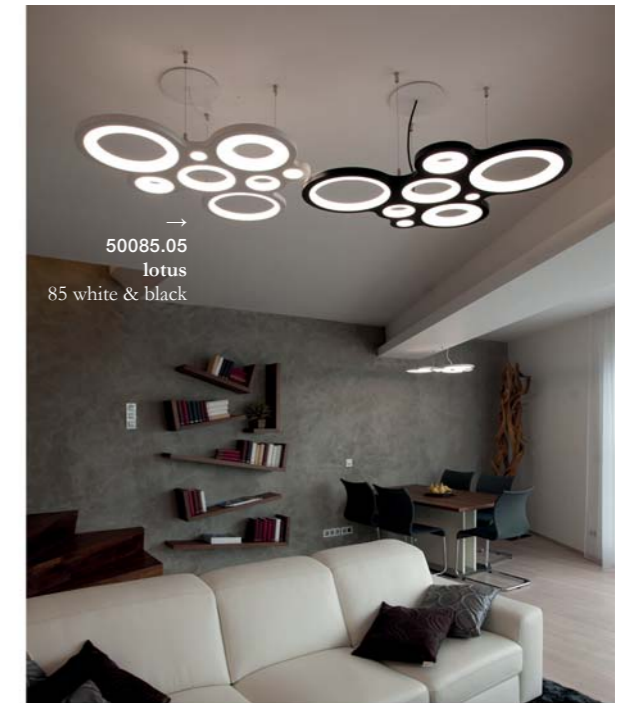

Provedení/Finish:

.04 .05

tube



tube 120/1000

tube 120/700

tube 120/500

tube 105/860

tube 105/600

tube 105/430

61210.00**61270.00****61250.00****61086.00****61060.00****61043.00**

výzbroj/equipment
11 W LED PAR 30
90mm, 680 lm
napětí/voltage
230 V

výzbroj/equipment
11 W LED PAR 30
90mm, 680 lm
napětí/voltage
230 V

výzbroj/equipment
11 W LED PAR 30
90mm, 680 lm
napětí/voltage
230 V

výzbroj/ equipment
11 W LED PAR 30
90mm, 680 lm
napětí/voltage
230 V

výzbroj/equipment
11 W LED PAR 30
90mm, 680 lm
napětí/voltage
230 V

výzbroj/equipment
11 W LED PAR 30
90mm, 680 lm
napětí/voltage
230 V

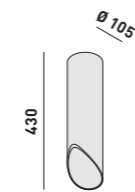
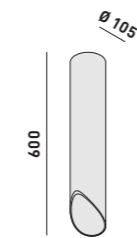
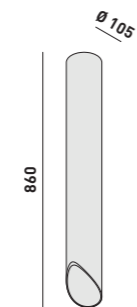
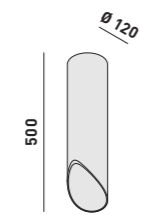
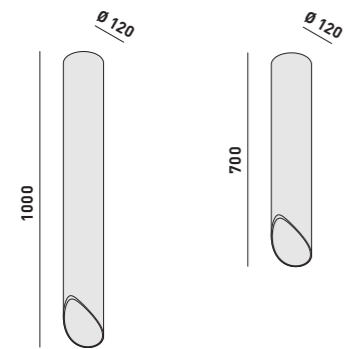

tube 75/740

tube 75/520

tube 75/360

tube 50/640

tube 50/430

tube 50/300

61210.00**61270.00****61250.00****61086.00****61060.00****61043.00**

výzbroj/equipment
11 W LED PAR 30
90mm, 345 lm
napětí/voltage
230 V

výzbroj/equipment
11 W LED PAR 30
90mm, 345 lm
napětí/voltage
230 V

výzbroj/equipment
11 W LED PAR 30
90mm, 345 lm
napětí/voltage
230 V

výzbroj/ equipment
11 W LED PAR 30
90mm, 190 lm
napětí/voltage
230 V

výzbroj/ equipment
11 W LED PAR 30
90mm, 190 lm
napětí/voltage
230 V

výzbroj/equipment
11 W LED PAR 30
90mm, 190 lm
napětí/voltage
230 V

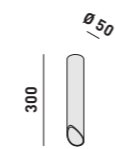
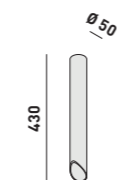
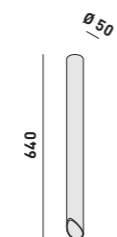
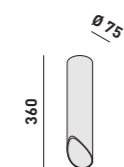
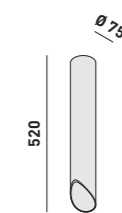
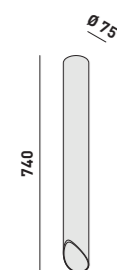

Provedení/Finish:



Tube je kolekci ambientních svítidel s minimalistickým designem. Jednoduchá, čistá forma bez viditelných spojů spolu s precizním provedením z nich dělá ideální architektonický prvek. Díky jednoduchému způsobu instalace a širokému výběru proporcí i barev lze vytvářet rozměrné a originální kompozice.



Tube is a collection of ambient lights with minimalist design. Simple and clean forms with no visible mounts and precision crafting make these fixtures ideal for architecture. Thanks to their simple installation and wide range of colors and sizes, one can create large original compositions.



mercur



mercur LED 1375

40137.00

výzbroj/equipment
42 W LED

napětí/voltage
12 V/DC

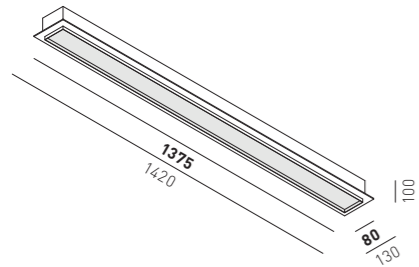

mercur LED 1075

41107.00

výzbroj/equipment
33 W LED

napětí/voltage
12 V/DC

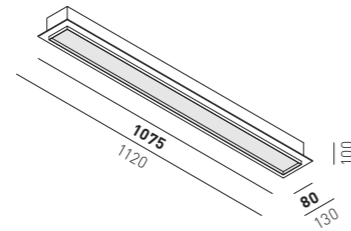

mercur LED 775

42775.00

výzbroj/equipment
24 W LED

napětí/voltage
12 V/DC

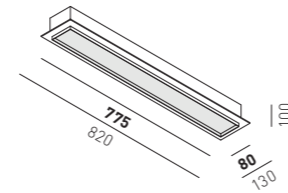

lotus LED 475

43475.00

výzbroj/equipment
15 W LED

napětí/voltage
12 V/DC

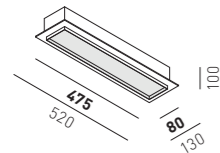

Mercur je kolekce minimalistických zápusných svítidel bez viditelného rámečku. Nabízené rozměry je možné propojovat mezi sebou a vytvářet tak plynulé světelné pruhy.

Mercur is a collection of minimalist recessed light fixtures without any visible frame. The dimensions offered can be combined to create continuous bands of light.

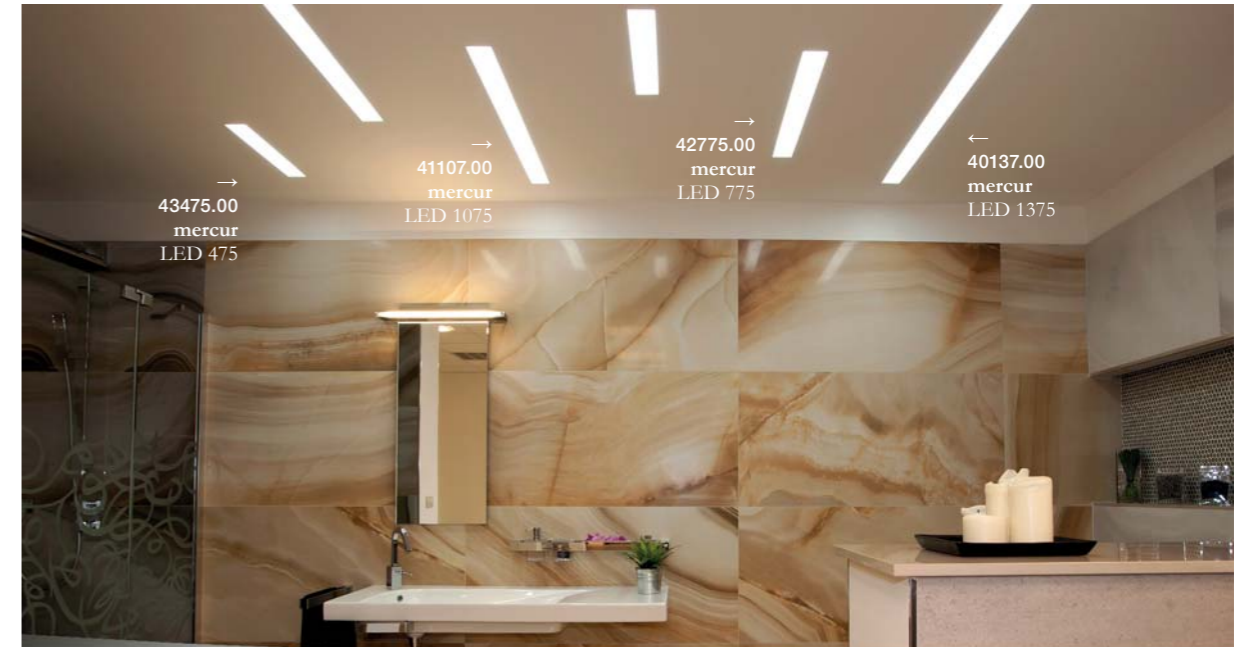

infos



infos 50

infos 30

infos 18

infos 14

16050.00

výzbroj/equipment
4x 36 W TC-L 2G11
8040 lm LED

napětí/voltage
230 V

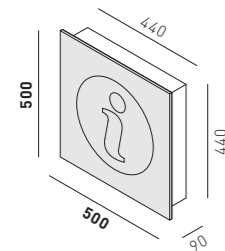
**16030.00**

výzbroj/equipment
2x 24 W TC-F 2G10
2010 lm LED

napětí/voltage
230 V

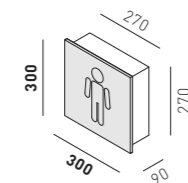
**16018.00**

výzbroj/equipment
1x 18 W TC-F 2G10
2000 lm LED

napětí/voltage
230 V

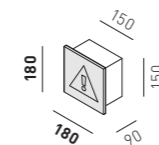
**16014.00**

výzbroj/equipment
2x 15 W E27

napětí/voltage
230 V

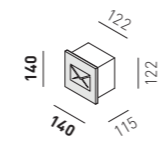

infos 64

infos 43

16064.00

výzbroj/equipment
1x 55 W TC-L 2G11
4134 lm LED

napětí/voltage
230 V

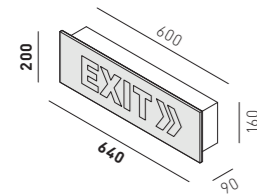
**16043.00**

výzbroj/equipment
1x 24 W TC-L 2G11
2756 lm LED

napětí/voltage
230 V

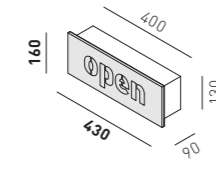

infos LED 15

16015.00

výzbroj/equipment
1,5 W LED

napětí/voltage
12 V DC

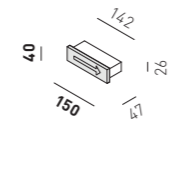

infos LED 8

16008.00

výzbroj/equipment
1 W LED

napětí/voltage
12 V DC



Z prvků kolekce infos lze vytvořit originální informační systém. Do plochy z nerezů je možné vyfrézovat logo, piktogram, text, nebo jakoukoliv jinou grafickou aplikaci dle požadavku.

The infos collection can be used to create original signage. Logos, pictograms, texts or any other graphics can be cut into stainless steel sheet to meet your needs.

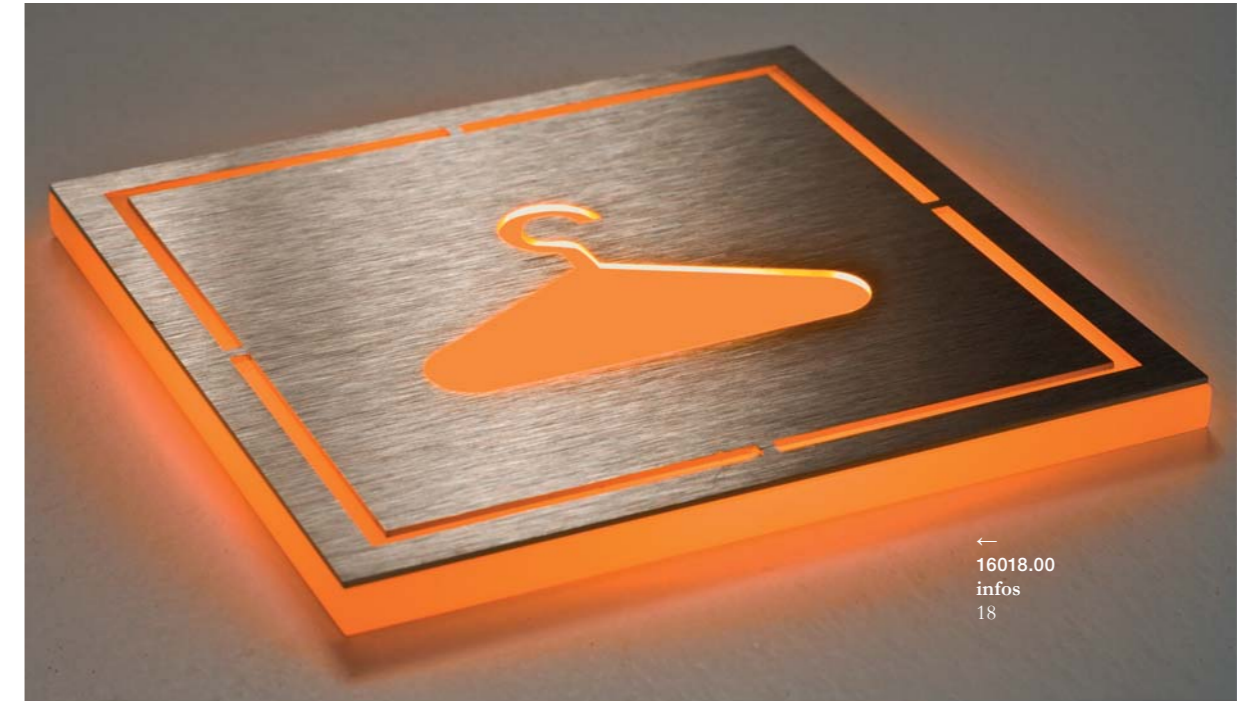

Provedení/Finish: .00 .01 .02

Rejstřík

Index

018

quadra

corona

quadra corona 95

12095.00

rozměry/dimensions
950 x 950 mm
 900 x 900 x 110 mm

váha/weight
14.9 kg

quadra corona 50

12050.00

rozměry/dimensions
500 x 500 mm
 440 x 440 x 90 mm

váha/weight
7.9 kg

quadra corona 30

12030.00

rozměry/dimensions
300 x 300 mm
 270 x 270 x 90 mm

váha/weight
2.9 kg

022

retro

corona

retro corona 110

15110.00

rozměry/dimensions
1100 x 1100 mm
 900 x 900 x 110 mm

váha/weight
15.8 kg

retro corona 54

15054.00

rozměry/dimensions
540 x 540 mm
 440 x 440 x 90 mm

váha/weight
8.9 kg

retro corona 32

15032.00

rozměry/dimensions
320 x 320 mm
 270 x 270 x 90 mm

váha/weight
3.1 kg

quadra corona 18

12018.00

rozměry/dimensions
180 x 180 mm
 150 x 150 x 90 mm

váha/weight
1.3 kg

quadra corona 14

12014.00

rozměry/dimensions
140 x 140 mm
 122 x 122 x 115 mm

váha/weight
1.1 kg

quadra corona 64

12064.00

rozměry/dimensions
640 x 200 mm
 600 x 160 x 90 mm

váha/weight
2.8 kg

quadra corona 43

12043.00

rozměry/dimensions
430 x 160 mm
 400 x 130 x 90 mm

váha/weight
2.7 kg

quadra LED corona 15

12015.00

rozměry/dimensions
150 x 40 mm
 142 x 26 x 47 mm

váha/weight
220 g

quadra LED corona 8

12008.00

rozměry/dimensions
80 x 80 mm
 Ø 68 mm

váha/weight
140 g

020

quadra

silky

quadra silky 50

14050.00

rozměry/dimensions
500 x 500 mm
 440 x 440 x 90 mm

váha/weight
7.9 kg

quadra silky 30

14030.00

rozměry/dimensions
300 x 300 mm
 270 x 270 x 90 mm

váha/weight
2.9 kg

quadra silky 18

14018.00

rozměry/dimensions
180 x 180 mm
 150 x 150 x 90 mm

váha/weight
1.3 kg

quadra silky 14

14014.00

rozměry/dimensions
140 x 140 mm
 122 x 122 x 115 mm

váha/weight
1.1 kg

quadra silky 64

14064.00

rozměry/dimensions
640 x 200 mm
 600 x 160 x 90 mm

váha/weight
2.8 kg

quadra silky 43

14043.00

rozměry/dimensions
430 x 160 mm
 400 x 130 x 90 mm

váha/weight
2.7 kg

quadra LED silky 15

14015.00

rozměry/dimensions
150 x 40 mm
 142 x 26 x 47 mm

váha/weight
220 g

quadra LED silky 8

14008.00

rozměry/dimensions
80 x 80 mm
 Ø 68 mm

váha/weight
140 g

retro corona 18

15018.00

rozměry/dimensions
180 x 180 mm
 150 x 150 x 90 mm

váha/weight
1.3 kg

retro corona 14

15014.00

rozměry/dimensions
140 x 140 mm
 122 x 122 x 115 mm

váha/weight
1.1 kg

retro LED corona 8

15008.00

rozměry/dimensions
80 x 80 mm
 Ø 68 mm

váha/weight
140 g

024

retro

silky

retro silky 54

17054.00

rozměry/dimensions
540 x 540 mm
 440 x 440 x 90 mm

váha/weight
8.9 kg

retro silky 32

17032.00

rozměry/dimensions
320 x 320 mm
 270 x 270 x 90 mm

váha/weight
3.1 kg

retro silky 18

17018.00

rozměry/dimensions
180 x 180 mm
 150 x 150 x 90 mm

váha/weight
1.3 kg

retro silky 14

17014.00

rozměry/dimensions
140 x 140 mm
 122 x 122 x 115 mm

váha/weight
1.1 kg

retro LED silky 8

17008.00

rozměry/dimensions
80 x 80 mm
 Ø 68 mm

váha/weight
140 g

026

zig zag

zig zag 128

18128.00

rozměry/dimensions
1280 x 1230 mm
 900 x 900 x 110 mm

váha/weight
16.1 kg

zig zag 72

18072.00

rozměry/dimensions
720 x 690 mm
 440 x 440 x 90 mm

váha/weight
8.9 kg

zig zag 44

18044.00

rozměry/dimensions
440 x 420 mm
 270 x 270 x 90 mm

váha/weight
3.1 kg

zig zag 22

18022.00

rozměry/dimensions
220 x 210 mm
 150 x 150 x 90 mm

váha/weight
1.3 kg

zig zag LED 10

18010.00

rozměry/dimensions
100 x 100 mm
 Ø 68 mm

váha/weight
140 g

028	up corona 95	up corona 50	up corona 35
up	19095.00	19050.00	19035.00
corona	rozměry/dimensions 950 x 950 x 100 mm	rozměry/dimensions 500 x 500 x 60 mm	rozměry/dimensions 350 x 350 x 60 mm
	váha/weight 17.8 kg	váha/weight 9.4 kg	váha/weight 4.8 kg

up corona 20	up corona 62	up corona 40	up LED corona 10
19020.00	19062.00	19040.00	19010.00
rozměry/dimensions 200 x 200 x 60 mm	rozměry/dimensions 620 x 180 x 60 mm	rozměry/dimensions 400 x 120 x 60 mm	rozměry/dimensions 100 x 100 x 60 mm
váha/weight 2.0 kg	váha/weight 3.6 kg	váha/weight 2.2 kg	váha/weight 600 g

030	mystic meridia 85	mystic meridia 65	mystic meridia 55
mystic	22085.00	22065.00	22055.00
meridia	rozměry/dimensions 850 x 850 x 70 mm	rozměry/dimensions 650 x 650 x 70 mm	rozměry/dimensions 550 x 550 x 70 mm
	váha/weight 9.2 kg	váha/weight 7.4 kg	váha/weight 6.9 kg

032	mystic dione 150+LED	mystic dione 150	mystic dione 113
mystic	22150.00+LED	22150.00	22113.00
dione	rozměry/dimensions 1500 x 500 x 20 mm	rozměry/dimensions 1500 x 500 x 20 mm	rozměry/dimensions 1130 x 320 x 20 mm
	váha/weight 16.7 kg	váha/weight 16.7 kg	váha/weight 11.3 kg

034	mystic metis 128	mystic metis 98	mystic metis 68
mystic	22128.00	22098.00	22068.00
metis	rozměry/dimensions 1280 x 80 x 50 mm	rozměry/dimensions 980 x 80 x 50 mm	rozměry/dimensions 680 x 80 x 50 mm
	váha/weight 2.1 kg	váha/weight 1.8 kg	váha/weight 1.5 kg

mystic metis 32	036	mystic io 10	mystic io 11
22032.00	mystic	22010.00	22011.00
rozměry/dimensions 320 x 320 x 60 mm	io	rozměry/dimensions 110 x 110 mm 100 x Ø 85 mm	rozměry/dimensions 110 x 110 mm 100 x Ø 85 mm
váha/weight 2.4 kg		váha/weight 450 g	váha/weight 450 g

038	x-line zen 48	x-line zen 37	x-line zen 18
x-line	23548.____	23537.____	23518.____
zen	rozměry/dimensions 480 x 480 x 80 mm	rozměry/dimensions 370 x 370 x 80 mm	rozměry/dimensions 480 x 180 x 80 mm
	váha/weight 2.9 kg	váha/weight 2.4 kg	váha/weight 1.9 kg

040	x-line color 48	x-line color 37	x-line color 18
x-line	23048.____	23037.____	23018.____
color	rozměry/dimensions 480 x 480 x 80 mm	rozměry/dimensions 370 x 370 x 80 mm	rozměry/dimensions 480 x 180 x 80 mm
	váha/weight 2.9 kg	váha/weight 2.4 kg	váha/weight 1.9 kg

042	ledissimo direct 22	ledissimo direct 17	ledissimo direct 14
ledissimo	24022.00	24017.00	24014.00
direct	rozměry/dimensions 880 x 480 x 20 mm	rozměry/dimensions 680 x 480 x 20 mm	rozměry/dimensions 680 x 480 x 20 mm
	váha/weight 3.1 kg	váha/weight 2.5 kg	váha/weight 2.1 kg

ledissimo direct 13	ledissimo direct 10	044	ledissimo indirect 22
24013.00	24010.00	ledissimo	24122.00
rozměry/dimensions 880 x 280 x 20 mm	rozměry/dimensions 680 x 280 x 20 mm	indirect	rozměry/dimensions 880 x 480 x 20 mm
váha/weight 2.0 kg	váha/weight 1.9 kg		váha/weight 3.1 kg

ledissimo indirect 17

24117.00**rozměry/dimensions**
680 x 480 x 20 mm**váha/weight**
2.5 kg

ledissimo indirect 14

24114.00**rozměry/dimensions**
680 x 480 x 20 mm**váha/weight**
2.1 kg

ledissimo indirect 13

24113.00**rozměry/dimensions**
880 x 280 x 20 mm**váha/weight**
2.0 kg

ledissimo indirect 10

24110.00**rozměry/dimensions**
680 x 280 x 20 mm**váha/weight**
1.9 kg

tube 50/300

61043.00**rozměry/dimensions**
300 x Ø50 mm**váha/weight**
1.1 kg

050

mercur

mercur LED 1375

40137.00**rozměry/dimensions**
1375 x 80 mm
1420 x 130 x 100 mm**váha/weight**
1.5 kg

mercur LED 1075

41107.00**rozměry/dimensions**
1075 x 80 mm
1120 x 130 x 100 mm**váha/weight**
1.2 kg

046

lotus

lotus 125

50125.____**rozměry/dimensions**
1250 x 1050 x 20 mm**váha/weight**
9.4 kg

lotus 85

50085.____**rozměry/dimensions**
850 x 680 x 20 mm**váha/weight**
6.2 kg

048

tube

tube 120/1000

61210.00**rozměry/dimensions**
1000 x Ø120 mm**váha/weight**
3.2 kg

tube 120/700

61270.00**rozměry/dimensions**
700 x Ø120 mm**váha/weight**
2.9 kg

tube 120/500

61250.00**rozměry/dimensions**
500 x Ø120 mm**váha/weight**
2.6 kg

tube 105/860

61086.00**rozměry/dimensions**
860 x Ø105 mm**váha/weight**
3.4 kg

tube 105/600

61060.00**rozměry/dimensions**
600 x Ø105 mm**váha/weight**
3.2 kg

tube 105/430

61043.00**rozměry/dimensions**
430 x Ø105 mm**váha/weight**
3.1 kg

tube 75/740

61210.00**rozměry/dimensions**
740 x Ø75 mm**váha/weight**
2.3 kg

tube 75/520

61270.00**rozměry/dimensions**
520 x Ø75 mm**váha/weight**
2.1 kg

tube 75/360

61250.00**rozměry/dimensions**
360 x Ø75 mm**váha/weight**
1.9 kg

tube 50/640

61086.00**rozměry/dimensions**
640 x Ø50 mm**váha/weight**
1.8 kg

tube 50/430

61060.00**rozměry/dimensions**
430 x Ø50 mm**váha/weight**
1.4 kg

mercur LED 775

42775.00**rozměry/dimensions**
775 x 80 mm
820 x 130 x 100 mm**váha/weight**
900 g

lotus LED 475

43475.00**rozměry/dimensions**
475 x 80 mm
520 x 130 x 100 mm**váha/weight**
700 g

infos 30

16030.00**rozměry/dimensions**
300 x 300 mm
270 x 270 x 90 mm**váha/weight**
2.9 kg

infos 18

16018.00**rozměry/dimensions**
180 x 180 mm
150 x 150 x 90 mm**váha/weight**
1.3 kg

infos 14

16014.00**rozměry/dimensions**
140 x 140 mm
122 x 122 x 115 mm**váha/weight**
1.1 kg

infos 64

16064.00**rozměry/dimensions**
640 x 200 mm
600 x 160 x 90 mm**váha/weight**
2.8 kg

infos 43

16043.00**rozměry/dimensions**
430 x 160 mm
400 x 130 x 90 mm**váha/weight**
2.7 kg

infos LED 15

16015.00**rozměry/dimensions**
150 x 40 mm
142 x 26 x 47 mm**váha/weight**
220 g

infos LED 8

16008.00**rozměry/dimensions**
80 x 80 mm
Ø 68 mm**váha/weight**
140 g

Materiály

Materials

Čiré akrylátové sklo

Akrylátové sklo

Čiré akrylátové sklo

Čiré akrylátové sklo Perspex® se vyznačuje vynikající propustností světla (92%), která je srovnatelná se sklem, odolností proti nárazu (5x odolnější než sklo ve stejné tloušťce) a nízkou hmotností (1,19 g/cm³). Lité akrylátové sklo Perspex® vykazuje nízké povrchové pnutí a je odolné vůči UV záření. Pro výrobu používáme barevné, transparentní a translucentní odstíny.

Neodymové magnety

Neodymové magnety (NdFeB)

Neodymové magnety

Neodymové magnety jsou v současnosti nejnovějším a nejsilnějším typem magnetu s vynikajícími magnetickými vlastnostmi a vůbec nejvyšší vnitřní energií jako je remanence a energetická hustota. Magnety uvedeného typu jsou schopny unést více než tisícínásobek vlastní hmotnosti a magnet o velikosti malé mince tak může udržet železný předmět o hmotnosti kolem 10 kg.

Nerezová ocel

Nerezová ocel

Nerezová ocel

Nerezová ocel

Nerezová ocel

Nerezová ocel

Nerezová ocel

Nerezová ocel

Nerezová ocel

Nerezová ocel

Nerezová ocel

Nerezová ocel

Nerezová ocel

Nerezová ocel

Nerezová ocel

Nerezová ocel

Nerezová ocel

Nerezová ocel

Nerezová ocel

Nerezová ocel

Nerezová ocel

Nerezová ocel

Nerezová ocel

Nerezová ocel

Nerezová ocel

Nerezová ocel

Nerezová ocel

Nerezová ocel

Nerezová ocel

Nerezová ocel

Nerezová ocel

Nerezová ocel

Nerezová ocel

Nerezová ocel

Nerezová ocel

Nerezová ocel

Nerezová ocel

Nerezová ocel

Nerezová ocel

Nerezová ocel

Nerezová ocel

Nerezová ocel

Nerezová ocel

Nerezová ocel

Nerezová ocel

Nerezová ocel

Nerezová ocel

Nerezová ocel

Nerezová ocel

Nerezová ocel

Nerezová ocel

Nerezová ocel

Nerezová ocel

Nerezová ocel

Nerezová ocel

Nerezová ocel

Nerezová ocel

Nerezová ocel

Acrylic glass

Acrylic glass

Acrylic glass

Clear Perspex® acrylic glass exhibits excellent light transmittance (92%) comparable to glass, impact resistance (5x more resistant than glass of the same thickness) and low weight (1.19 g/cm³). Cast Perspex® acrylic glass also has low surface tension and is resistant to UV radiation. For production we use colored, transparent and translucent shades.

Neodymium magnets

Neodymium magnets

Neodymium magnets

Neodymium magnets

Neodymium magnets

Neodymium magnets

Neodymium magnets

Neodymium magnets

Neodymium magnets

Neodymium magnets

Neodymium magnets

Neodymium magnets

Neodymium magnets

Neodymium magnets

Neodymium magnets

Neodymium magnets

Neodymium magnets

Neodymium magnets

Neodymium magnets

Neodymium magnets

Neodymium magnets

Neodymium magnets

Neodymium magnets

Neodymium magnets

Neodymium magnets

Neodymium magnets

Neodymium magnets

Neodymium magnets

Neodymium magnets

Neodymium magnets

Neodymium magnets

Neodymium magnets

Neodymium magnets

Neodymium magnets

Neodymium magnets

Neodymium magnets

Neodymium magnets

Neodymium magnets

Neodymium magnets

Neodymium magnets

Neodymium magnets

Neodymium magnets

Neodymium magnets

Neodymium magnets

Neodymium magnets

Neodymium magnets

Neodymium magnets

Neodymium magnets

Neodymium magnets

Neodymium magnets

Neodymium magnets

Neodymium magnets

Neodymium magnets

Neodymium magnets

Neodymium magnets

Neodymium magnets

Neodymium magnets

Neodymium magnets

Neodymium magnets

Neodymium magnets

Neodymium magnets

Neodymium magnets

Neodymium magnets

Neodymium magnets

Neodymium magnets

Neodymium magnets

Neodymium magnets

Neodymium magnets

Neodymium magnets

Neodymium magnets

Neodymium magnets

Neodymium magnets

Neodymium magnets

Neodymium magnets

Neodymium magnets

Neodymium magnets

LED zdroje

LED zdroje

LED zdroje

V produktech Luxlighting jsou použity výhradně LED moduly TRIDONIC. Moduly mají vysokou účinnost až 168 lm/W, vysoký index podání barev (CRI>80), vydávají perfektně uniformní světlo i v případě propojení několika modulů v řadě. Barevná teploty jsou k dispozici 3000, 4000 a 5000 K. LED moduly nevyžadují přídavné chlazení, jsou osazeny systémem pro snadné propojování jednotlivých modulů, vyznačují se snadnou instalací, dlouhou životností (50.000 hodin) a je na ně poskytována pětiletá záruka.

LED zdroje

LED zdroje

LED zdroje

LED zdroje

LED zdroje

LED zdroje

LED zdroje

LED zdroje

LED zdroje

LED zdroje

LED zdroje

LED zdroje

LED zdroje

LED zdroje

LED zdroje

LED zdroje

LED zdroje

LED zdroje

LED zdroje

LED zdroje

LED zdroje

LED zdroje

LED zdroje

LED zdroje

LED zdroje

LED zdroje

LED zdroje

LED zdroje

LED zdroje

LED zdroje

LED zdroje

LED zdroje

LED zdroje

LED zdroje

LED zdroje

LED zdroje

LED zdroje

LED zdroje

LED zdroje

LED zdroje

LED zdroje

LED zdroje

LED zdroje

LED zdroje

LED zdroje

LED zdroje

LED zdroje

LED zdroje

LED zdroje

LED zdroje

LED zdroje

LED zdroje

LED zdroje

LED zdroje

LED zdroje

LED zdroje

LED zdroje

LED zdroje

LED zdroje

LED zdroje

LED zdroje

LED zdroje

LED zdroje

LED zdroje

LED zdroje

LED zdroje

LED zdroje

LED zdroje

LED zdroje

LED zdroje

LED zdroje

LED zdroje

LED zdroje

LEDs

LED zdroje

Luxlighting products exclusively use TRIDONIC LED modules. The modules are extremely efficient, up to 168 lm / W, with a high color rendering index (CRI> 80), providing perfectly uniform light even when several modules are connected in series. Color temperatures are available for 3000, 4000 and 5000 K. The LED modules do not require additional cooling, are fitted to enable easy connection of individual modules, are easy to install, have a long life (50,000 hours) and come with a five-year warranty.

LED zdroje

LED zdroje

LED zdroje

LED zdroje

LED zdroje

LED zdroje

LED zdroje

LED zdroje

LED zdroje

LED zdroje

LED zdroje

LED zdroje

LED zdroje

LED zdroje

LED zdroje

LED zdroje

LED zdroje

LED zdroje

LED zdroje

LED zdroje

LED zdroje

LED zdroje

LED zdroje

LED zdroje

LED zdroje

LED zdroje

LED zdroje

LED zdroje

LED zdroje

LED zdroje

LED zdroje

LED zdroje

LED zdroje

LED zdroje

LED zdroje

LED zdroje

LED zdroje

LED zdroje

LED zdroje

LED zdroje

LED zdroje

LED zdroje

LED zdroje

LED zdroje

LED zdroje

LED zdroje

LED zdroje

LED zdroje

LED zdroje

LED zdroje

LED zdroje

LED zdroje

LED zdroje

LED zdroje

LED zdroje

LED zdroje

LED zdroje

LED zdroje

LED zdroje

LED zdroje

LED zdroje

LED zdroje

LED zdroje

LED zdroje

LED zdroje

LED zdroje

LED zdroje

LED zdroje

LED zdroje

LED zdroje

LED zdroje

LED zdroje

LED zdroje

Nerezová ocel